

N-Channel Enhancement Mode Power MOSFET

MTN2N65BJ3

BV_{DSS}	650V
I_D @ V_{GS}=10V, T_C=25°C	2A
I_D @ V_{GS}=10V, T_C=100°C	1.3A
R_{DS(ON)}@ V_{GS}=10V, I_D=1A	3.9Ω (typ)

Features

- Low On Resistance
- Simple Drive Requirement
- Low Gate Charge
- Fast Switching Characteristic
- Pb-free lead plating and halogen-free package

Applications

- Open Framed Power Supply
- Adapter
- STB

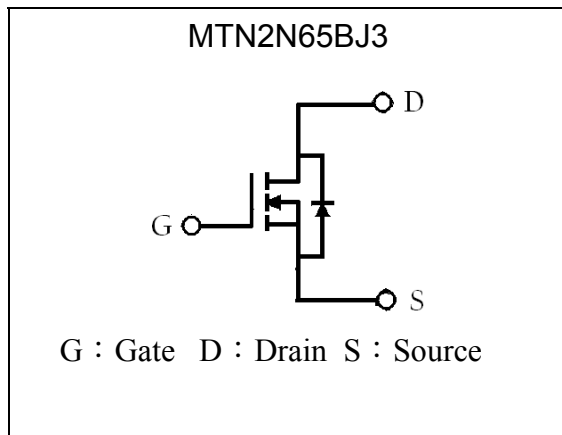
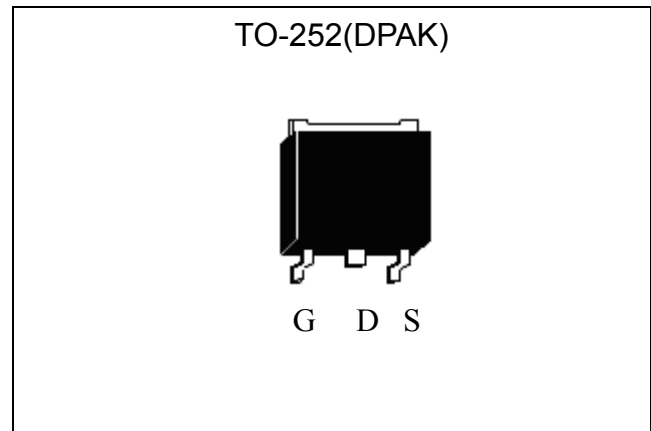
Symbol

Outline

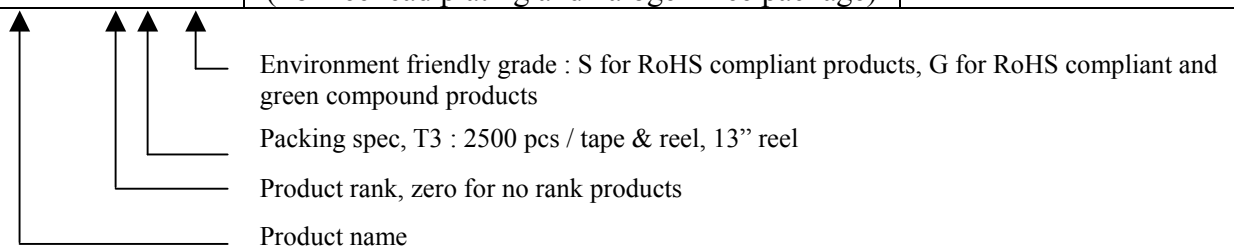
Ordering Information

Device	Package	Shipping
MTN2N65BJ3-0-T3-G	TO-252 (Pb-free lead plating and halogen-free package)	2500 pcs / Tape & Reel



**Absolute Maximum Ratings** ($T_C=25^{\circ}\text{C}$)

Parameter	Symbol	Limits	Unit
Drain-Source Voltage	V_{DS}	650	V
Gate-Source Voltage	V_{GS}	± 30	V
Continuous Drain Current	I_D	2.0	A
Continuous Drain Current @ $T_C=100^{\circ}\text{C}$		1.3	A
Pulsed Drain Current @ $V_{GS}=10\text{V}$ (Note 1)	I_{DM}	8.0	A
Single Pulse Avalanche Energy (Note 2)	E_{AS}	10	mJ
Single Pulse Avalanche Current (Note 2)	I_{AS}	2	A
Repetitive Avalanche Energy (Note 1)	E_{AR}	4.4	mJ
Peak Diode Recovery dv/dt (Note 3)	dv/dt	4.5	V/ns
Maximum Temperature for Soldering @ Lead at 0.125 in(0.318mm) from case for 10 seconds	T_L	300	$^{\circ}\text{C}$
Total Power Dissipation ($T_A=25^{\circ}\text{C}$)	P_D	1.14	W
Total Power Dissipation ($T_C=25^{\circ}\text{C}$)		44	W
Linear Derating Factor		0.35	W/ $^{\circ}\text{C}$
Operating Junction and Storage Temperature	T_j, T_{stg}	-55~+150	$^{\circ}\text{C}$

Note : 1.Repetitive rating; pulse width limited by maximum junction temperature.

2. $I_{AS}=2\text{A}$, $V_{DD}=50\text{V}$, $L=5\text{mH}$, $R_G=25\Omega$, starting $T_J=+25^{\circ}\text{C}$.

3. $I_{SD}\leq 1.8\text{A}$, $dI/dt\leq 100\text{A}/\mu\text{s}$, $V_{DD}\leq BV_{DSS}$, starting $T_J=+25^{\circ}\text{C}$.

Thermal Data

Parameter	Symbol	Value	Unit
Thermal Resistance, Junction-to-case, max	$R_{th,j-c}$	2.8	$^{\circ}\text{C}/\text{W}$
Thermal Resistance, Junction-to-ambient, max	$R_{th,j-a}$	110	$^{\circ}\text{C}/\text{W}$

Characteristics (Tc=25°C, unless otherwise specified)

Symbol	Min.	Typ.	Max.	Unit	Test Conditions
Static					
BV _{DSS}	650	-	-	V	V _{GS} =0V, I _D =250μA, T _j =25°C
ΔBV _{DSS} /ΔT _j	-	0.7	-	V/°C	Reference to 25°C, I _D =250μA
V _{GS(th)}	2.0	-	4.0	V	V _{DS} = V _{GS} , I _D =250μA
*G _{FS}	-	2.8	-	S	V _{DS} =15V, I _D =1A
I _{GSS}	-	-	±100	nA	V _{GS} =±30V
I _{DSS}	-	-	1	μA	V _{DS} =650V, V _{GS} =0V
	-	-	10		V _{DS} =520V, V _{GS} =0V, T _C =125°C
*R _{DS(ON)}	-	3.9	5.5	Ω	V _{GS} =10V, I _D =1A
Dynamic					
*Q _g	-	11.4	17	nC	I _D =2A, V _{DD} =520V, V _{GS} =10V
*Q _{gs}	-	2.3	-		
*Q _{gd}	-	5.7	-		
*t _{d(ON)}	-	8.4	16.8	ns	V _{DD} =325V, I _D =1.8A, V _{GS} =10V, R _G =25Ω
*t _r	-	8.4	16.8		
*t _{d(OFF)}	-	21.2	42.4		
*t _f	-	11.6	23.2		
C _{iss}	-	324	486	pF	V _{GS} =0V, V _{DS} =25V, f=1MHz
C _{oss}	-	37	56		
C _{rss}	-	19	29		
R _g	-	3.4	-	Ω	f=1MHz
Source-Drain Diode					
*I _S	-	-	2	A	
*I _{SM}	-	-	8		
*V _{SD}	-	0.79	1.5	V	I _S =1A, V _{GS} =0V
*t _{rr}	-	252	-	ns	V _{GS} =0, I _F =1.8A, dI/dt=100A/μs
*Q _{rr}	-	653	-	nC	

*Pulse Test : Pulse Width ≤300μs, Duty Cycle≤2%

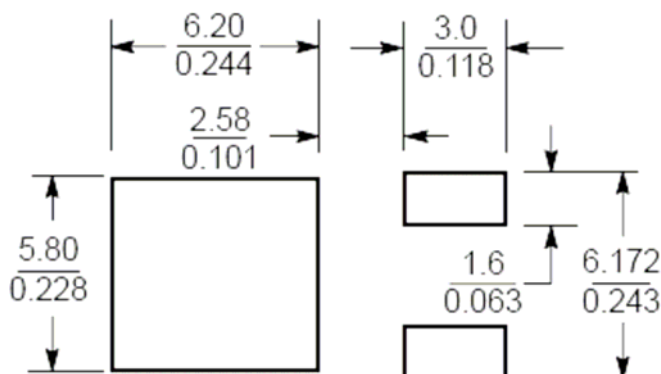
Recommended soldering footprint

 Unit ($\frac{\text{mm}}{\text{inch}}$)

Typical Characteristics

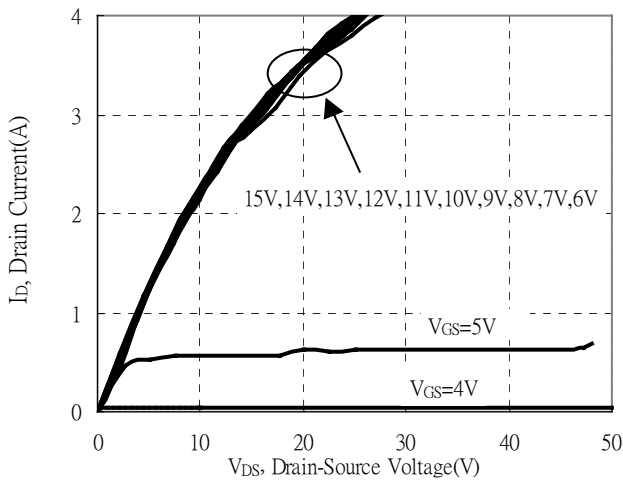
Typical Output Characteristics

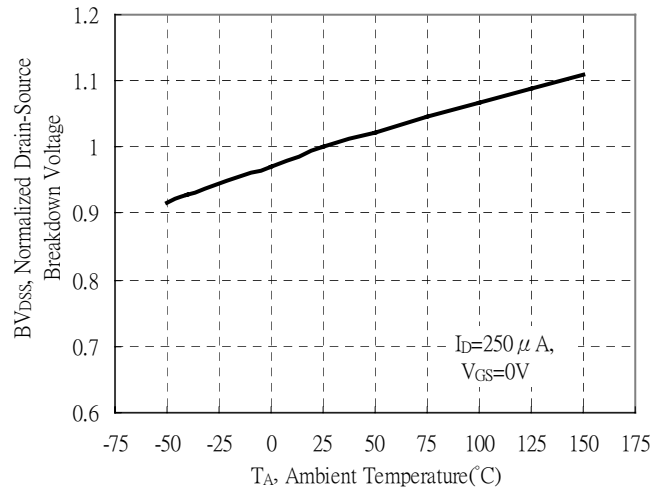

Brekdown Voltage vs Ambient Temperature



Static Drain-Source On-State resistance vs Drain Current

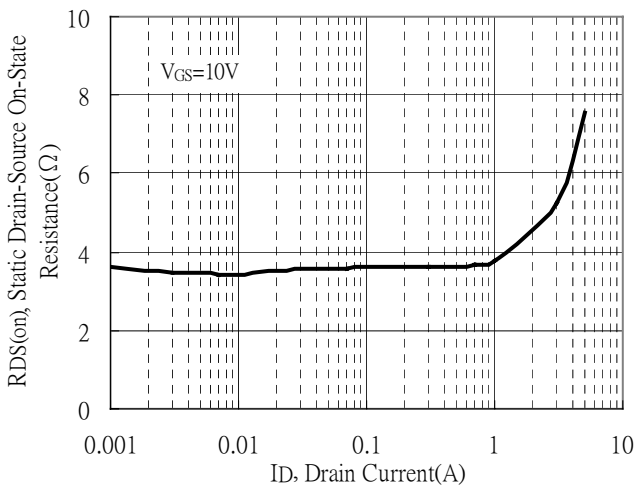

Drain Current vs Gate-Source Voltage

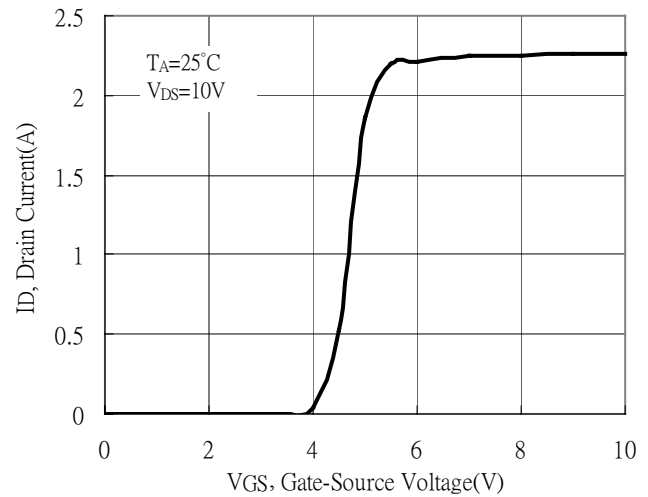

Static Drain-Source On-State Resistance vs Gate-Source Voltage

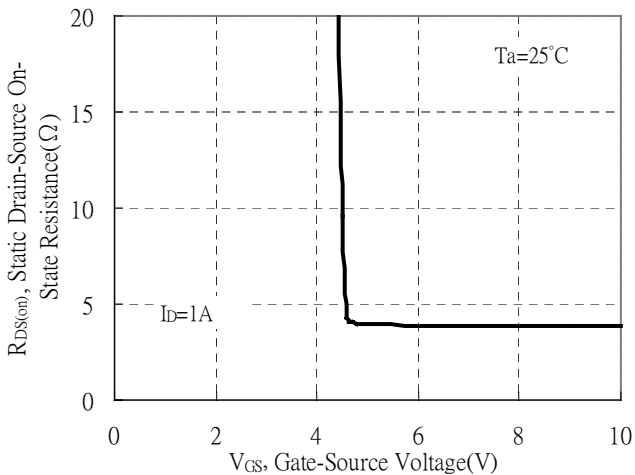

Forward Drain Current vs Source-Drain Voltage

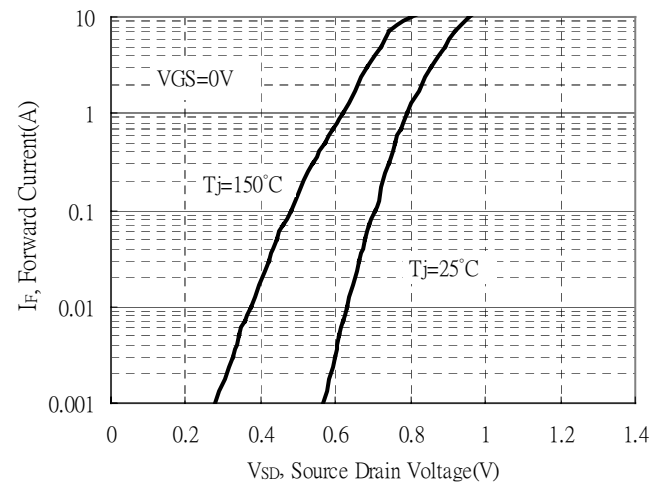

Typical Characteristics(Cont.)

Capacitance vs Reverse Voltage

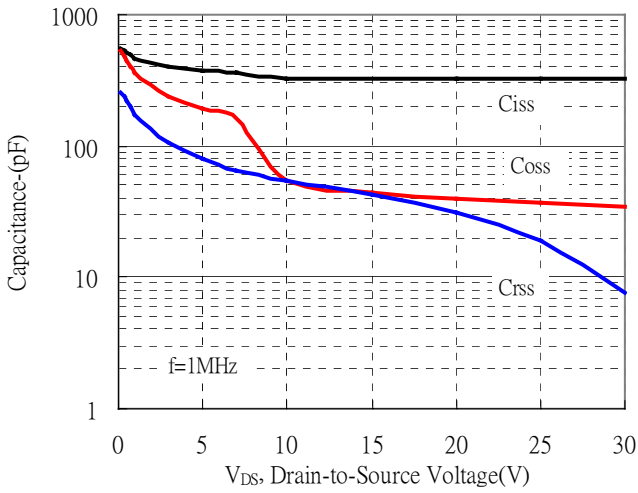

Static Drain-Source On-resistance vs Ambient Temperature

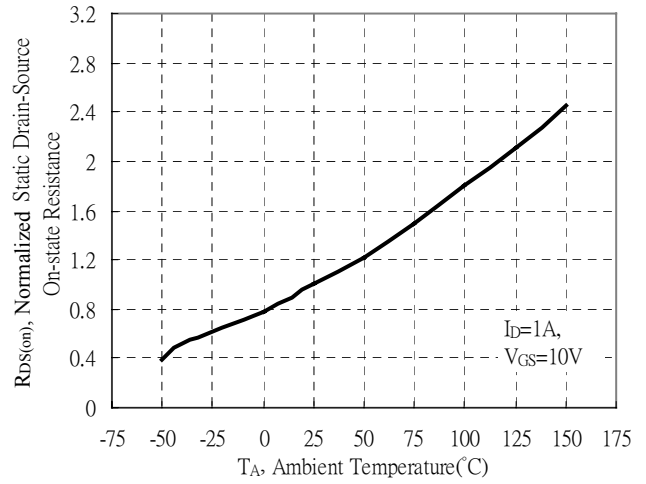

Maximum Safe Operating Area

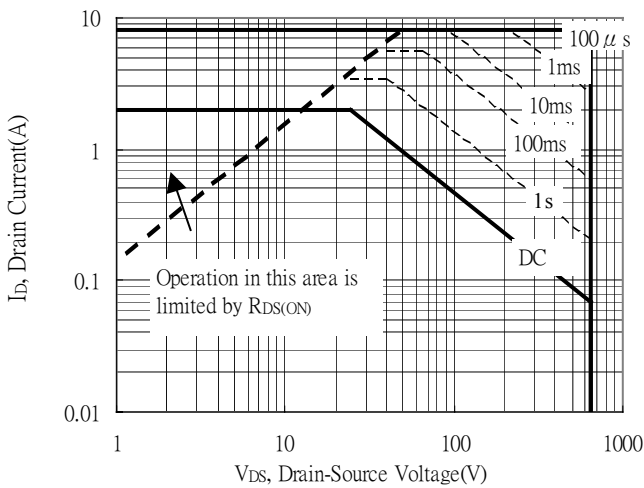

Gate Charge Characteristics

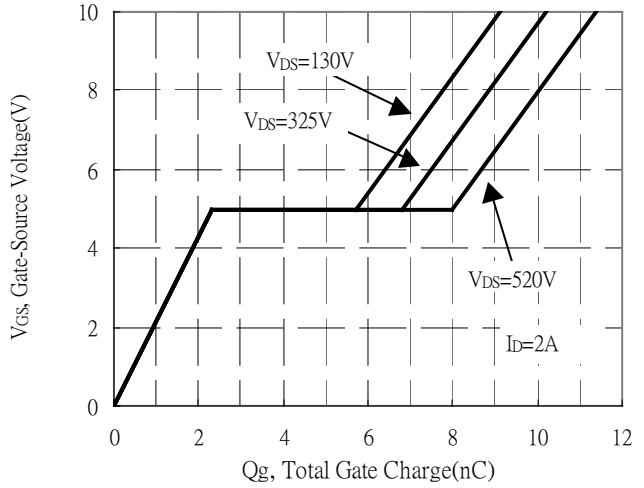

Maximum Drain Current vs Case Temperature

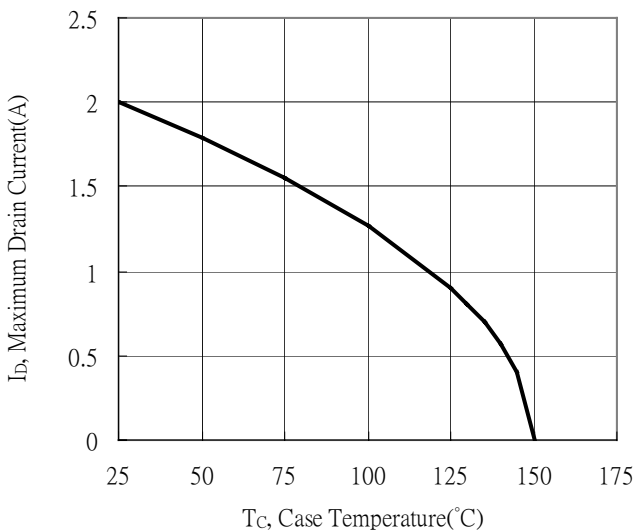

Threshold Voltage vs Junction Temperature

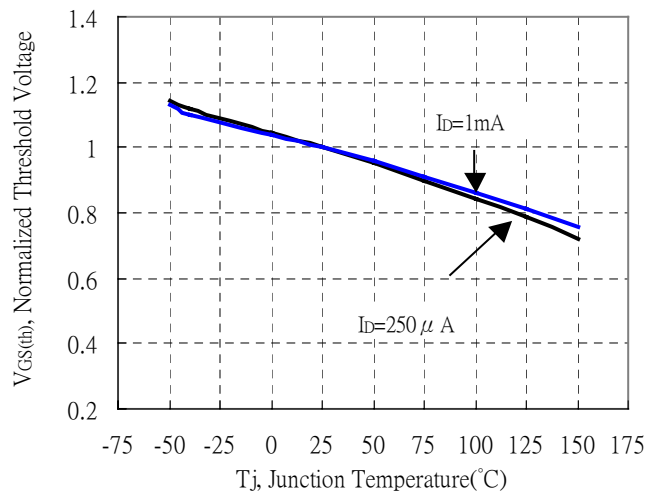



Typical Characteristics(Cont.)

Single Pulse Power Rating, Junction to Case

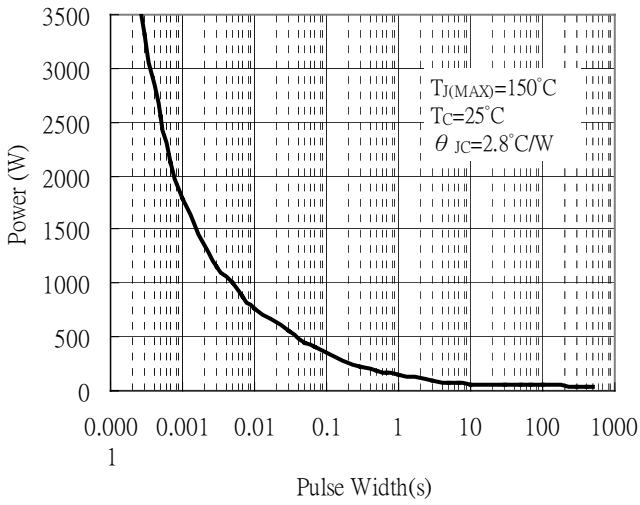

Forward Transfer Admittance vs Drain Current

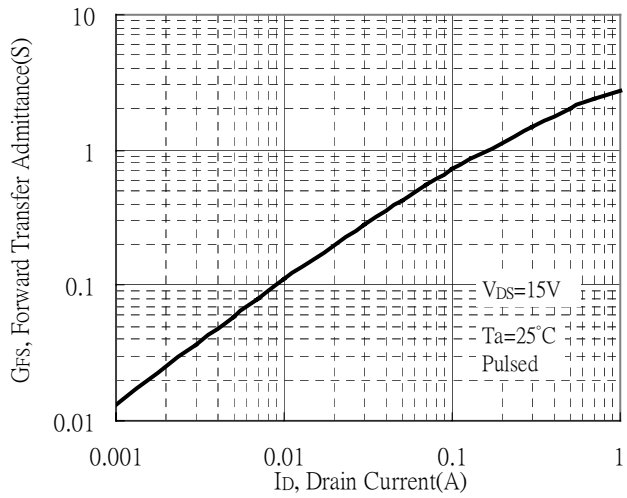

Transient Thermal Response Curves

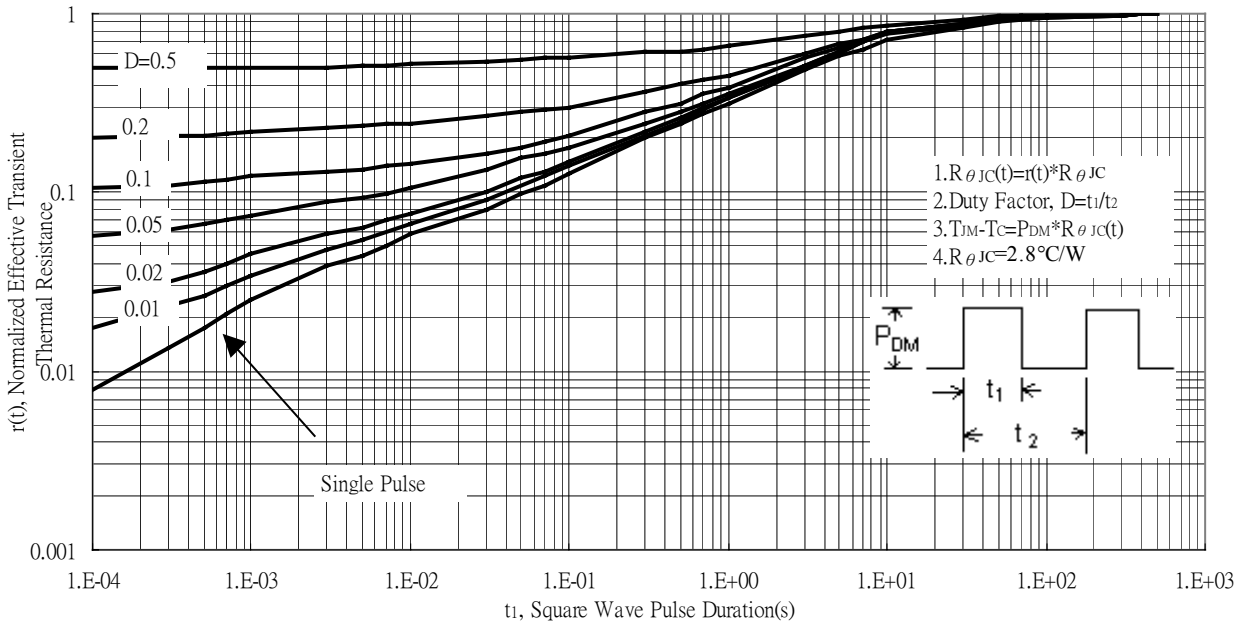

Recommended wave soldering condition

Product	Peak Temperature	Soldering Time
Pb-free devices	260 +0/-5 °C	5 +1/-1 seconds

Recommended temperature profile for IR reflow

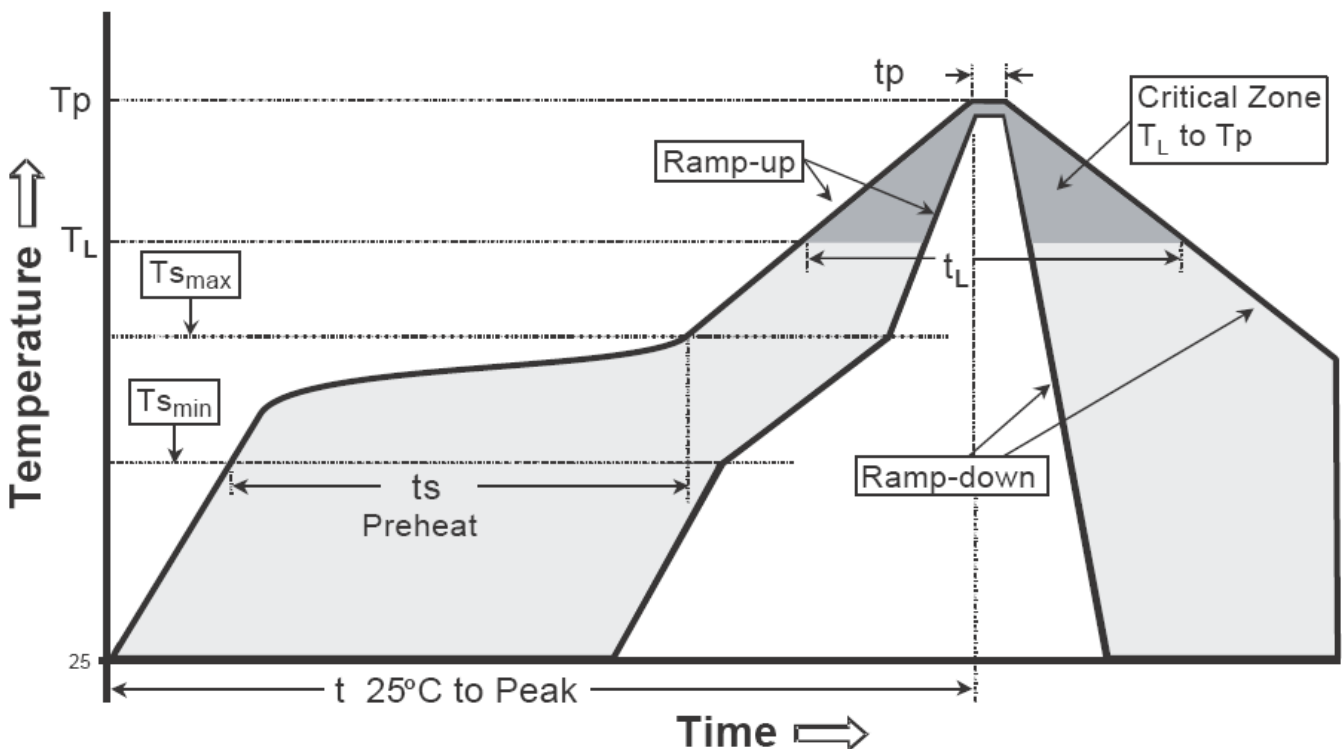

Profile feature	Sn-Pb eutectic Assembly	Pb-free Assembly
Average ramp-up rate (Ts_max to Tp)	3°C/second max.	3°C/second max.
Preheat		
-Temperature Min(Ts_min)	100°C	150°C
-Temperature Max(Ts_max)	150°C	200°C
-Time(ts_min to ts_max)	60-120 seconds	60-180 seconds
Time maintained above:		
-Temperature (T_L)	183°C	217°C
- Time (t_L)	60-150 seconds	60-150 seconds
Peak Temperature(T_P)	240 +0/-5 °C	260 +0/-5 °C
Time within 5°C of actual peak temperature(tp)	10-30 seconds	20-40 seconds
Ramp down rate	6°C/second max.	6°C/second max.
Time 25 °C to peak temperature	6 minutes max.	8 minutes max.

Note : All temperatures refer to topside of the package, measured on the package body surface.

TO-252 Dimension

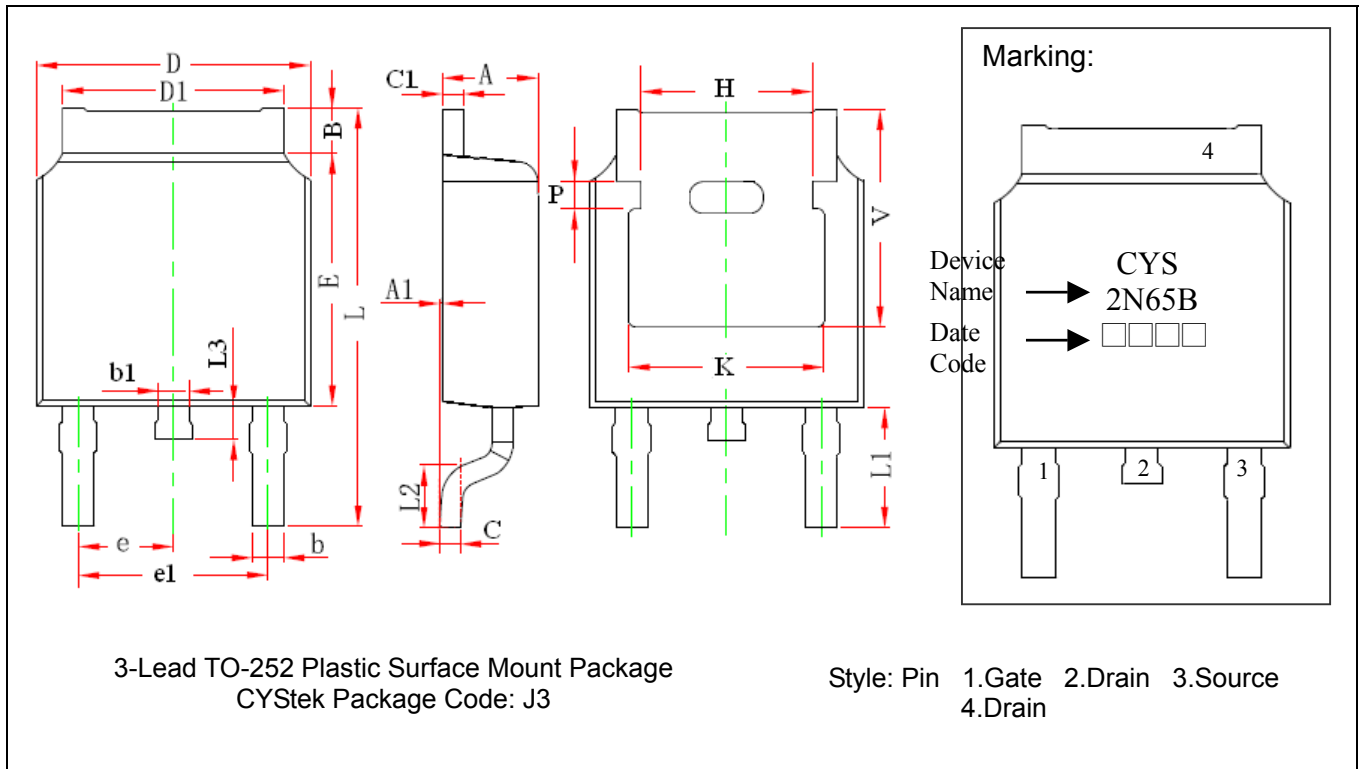

DIM	Inches		Millimeters		DIM	Inches		Millimeters	
	Min.	Max.	Min.	Max.		Min.	Max.	Min.	Max.
A	0.087	0.094	2.200	2.400	e	0.086	0.094	2.186	2.386
A1	0.000	0.005	0.000	0.127	e1	0.172	0.188	4.372	4.772
B	0.039	0.048	0.990	1.210	H	0.163	REF	4.140	REF
b	0.026	0.034	0.660	0.860	K	0.190	REF	4.830	REF
b1	0.026	0.034	0.660	0.860	L	0.386	0.409	9.800	10.400
C	0.018	0.023	0.460	0.580	L1	0.114	REF	2.900	REF
C1	0.018	0.023	0.460	0.580	L2	0.055	0.067	1.400	1.700
D	0.256	0.264	6.500	6.700	L3	0.024	0.039	0.600	1.000
D1	0.201	0.215	5.100	5.460	P	0.026	REF	0.650	REF
E	0.236	0.244	6.000	6.200	V	0.211	REF	5.350	REF

Notes: 1.Controlling dimension: millimeters.
 2.Maximum lead thickness includes lead finish thickness, and minimum lead thickness is the minimum thickness of base material.
 3.If there is any question with packing specification or packing method, please contact your local CYStek sales office.

Material:

- Lead : Pure tin plated.
- Mold Compound: Epoxy resin family, flammability solid burning class: UL94V-0.

Important Notice:

- All rights are reserved. Reproduction in whole or in part is prohibited without the prior written approval of CYStek.
- CYStek reserves the right to make changes to its products without notice.
- CYStek **semiconductor products are not warranted to be suitable for use in Life-Support Applications, or systems.**
- CYStek assumes no liability for any consequence of customer product design, infringement of patents, or application assistance.