

N-Channel Enhancement Mode Power MOSFET

MTN18N50CE3

BV_{DSS}	500V
I_D@V_{GS}=10V, T_C=25°C	18A
R_{DS(ON)}@V_{GS}=10V, I_D=9A	211mΩ (typ)

Features

- Low On Resistance
- Simple Drive Requirement
- Low Gate Charge
- Fast Switching Characteristic
- RoHS compliant package

Applications

- Power Factor Correction
- Flat Panel Power
- Full and Half Bridge Power Supplies
- Two-Transistor Forward Power Supplies

Symbol

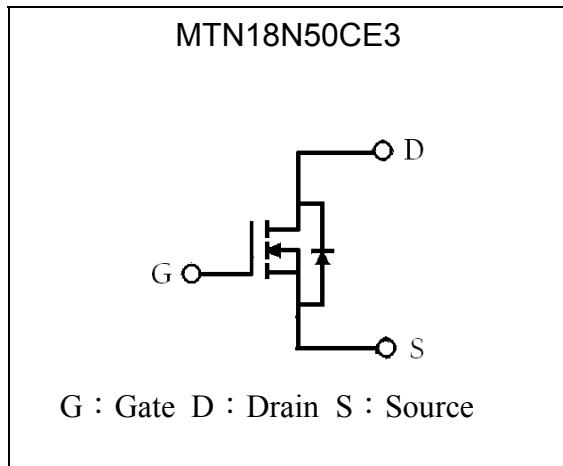

Outline

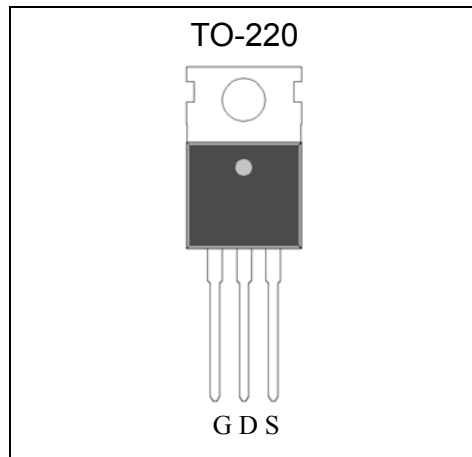

Ordering Information

Device	Package	Shipping
MTN18N50E3-0-UB-X	TO-220 (RoHS compliant package)	50 pcs/tube, 20 tubes/box, 4 boxes / carton

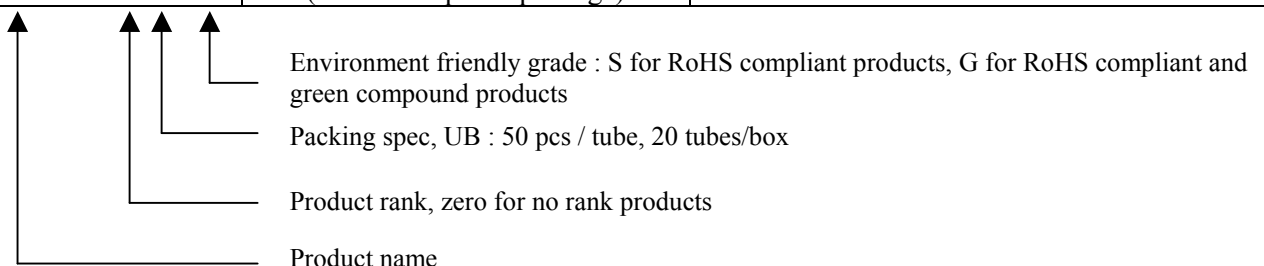

**Absolute Maximum Ratings** ($T_C=25^\circ\text{C}$)

Parameter	Symbol	Limits	Unit
Drain-Source Voltage (Note 1)	V_{DS}	500	V
Gate-Source Voltage	V_{GS}	± 30	
Continuous Drain Current @ $T_C=25^\circ\text{C}$, $V_{GS}=10\text{V}$	I_D	18*	A
Continuous Drain Current @ $T_C=100^\circ\text{C}$, $V_{GS}=10\text{V}$		11.4*	
Pulsed Drain Current @ $V_{GS}=10\text{V}$ (Note 2)	I_{DM}	72*	
Single Pulse Avalanche Energy (Note 4)	E_{AS}	112	mJ
Avalanche Current (Note 2)	I_{AS}	18	A
Repetitive Avalanche Energy (Note 2)	E_{AR}	21	mJ
Peak Diode Recovery dv/dt (Note 3)	dv/dt	4.5	V/ns
Maximum Temperature for Soldering @ Lead at 0.125 in(3.175mm) from case for 10 seconds	T_L	300	$^\circ\text{C}$
Total Power Dissipation ($T_C=25^\circ\text{C}$)	P_D	208	W
Linear Derating Factor above 25°C		1.67	W/ $^\circ\text{C}$
Operating Junction and Storage Temperature	T_J, T_{stg}	-55~+150	$^\circ\text{C}$

*Drain current limited by maximum junction temperature

Note : 1. $T_J=+25^\circ\text{C}$ to $+150^\circ\text{C}$.

2. Repetitive rating; pulse width limited by maximum junction temperature.

3. $I_{SD}=18\text{A}$, $dI/dt < 100\text{A}/\mu\text{s}$, $V_{DD} < BV_{DSS}$, $T_J=+150^\circ\text{C}$.4. $I_{AS}=15\text{A}$, $V_{DD}=30\text{V}$, $L=1\text{mH}$, $R_G=25\Omega$, starting $T_J=+25^\circ\text{C}$. 100% tested by condition of $L=0.1\text{mH}$, $I_{AS}=12\text{A}$, $V_{DD}=30\text{V}$, $V_{GS}=10\text{V}$ **Thermal Data**

Parameter	Symbol	Value	Unit
Thermal Resistance, Junction-to-case, max	$R_{th,j-c}$	0.6	$^\circ\text{C}/\text{W}$
Thermal Resistance, Junction-to-ambient, max	$R_{th,j-a}$	62.5	



Characteristics (Tj=25°C, unless otherwise specified)

Symbol	Min.	Typ.	Max.	Unit	Test Conditions
Static					
BV _{DSS}	500	-	-	V	V _{GS} =0V, I _D =250μA
ΔBV _{DSS} /ΔT _j	-	0.5	-	V/°C	Reference to 25°C, I _D =250μA
V _{GS(th)}	2.0	-	4.0	V	V _{DS} = V _{GS} , I _D =250μA
*G _{FS}	-	24	-	S	V _{DS} =15V, I _D =9A
I _{GSS}	-	-	±100	nA	V _{GS} =±30V
I _{DSS}	-	-	1	μA	V _{DS} =500V, V _{GS} =0V
	-	-	25		V _{DS} =400V, V _{GS} =0V, T _j =125°C
*R _{DS(ON)}	-	211	265	mΩ	V _{GS} =10V, I _D =9A
Dynamic					
*Q _g	-	70.5	-	nC	I _D =18A, V _{DD} =400V, V _{GS} =10V
*Q _{gs}	-	13.5	-		
*Q _{gd}	-	20.9	-		
*t _{d(ON)}	-	31	-	ns	V _{DD} =250V, I _D =18A, V _{GS} =10V, R _G =25Ω
*t _r	-	61	-		
*t _{d(OFF)}	-	239	-		
*t _f	-	88	-		
C _{iss}	-	3074	-	pF	V _{GS} =0V, V _{DS} =25V, f=1MHz
C _{oss}	-	281	-		
C _{rss}	-	48	-		
Source-Drain Diode					
*I _S	-	-	18	A	
*I _{SM}	-	-	72		
*V _{SD}	-	0.84	1.2	V	I _S =18A, V _{GS} =0V
*t _{rr}	-	350	-	ns	V _{GS} =0V, I _F =18A, dI _F /dt=100A/μs
*Q _{rr}	-	4.1	-	μC	

*Pulse Test : Pulse Width ≤300μs, Duty Cycle≤2%



Typical Characteristics

Typical Output Characteristics

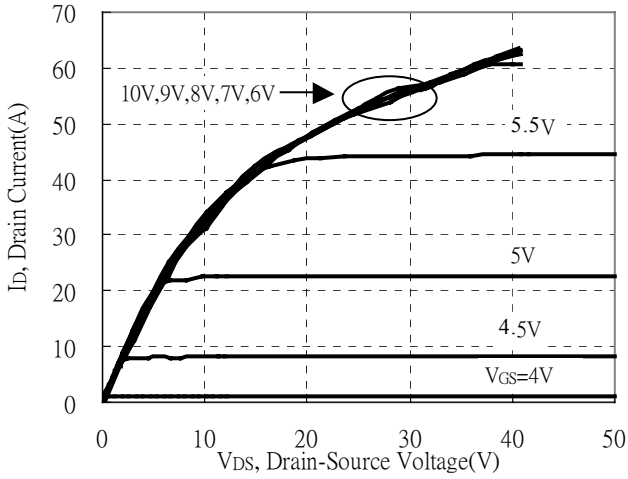

Brekdown Voltage vs Junction Temperature

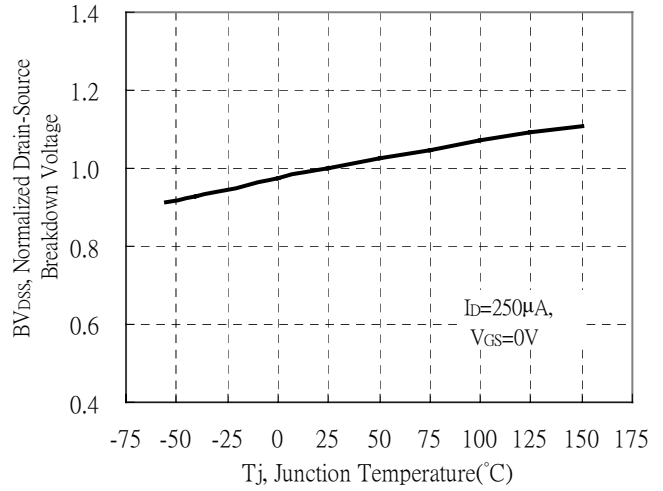

Static Drain-Source On-State resistance vs Drain Current

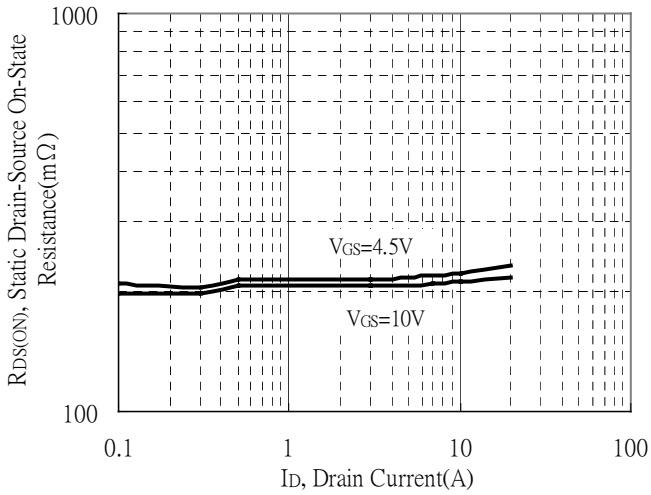

Reverse Drain Current vs Source-Drain Voltage

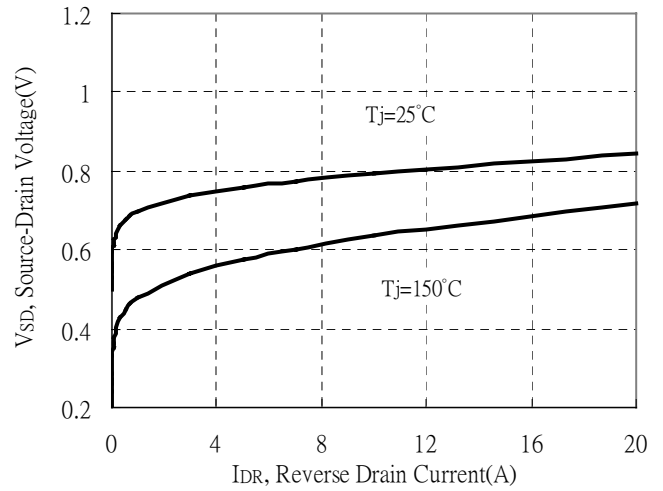

Static Drain-Source On-State Resistance vs Gate-Source Voltage

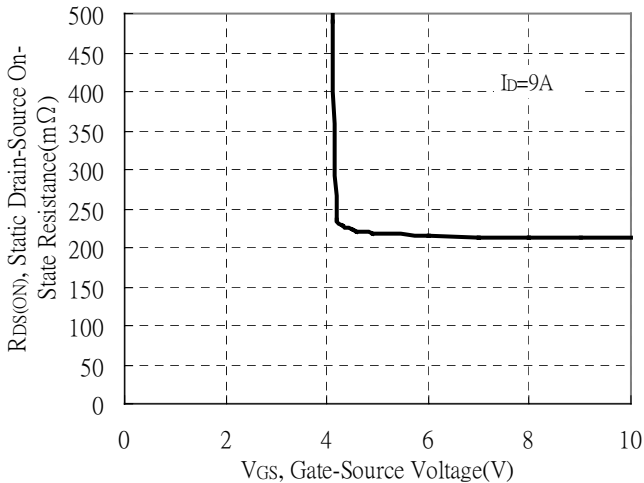

Drain-Source On-State Resistance vs Junction Temperature

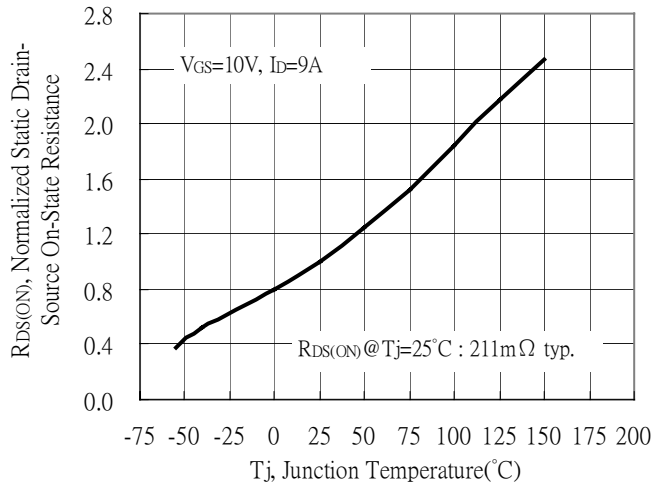



Typical Characteristics(Cont.)

Capacitance vs Drain-to-Source Voltage

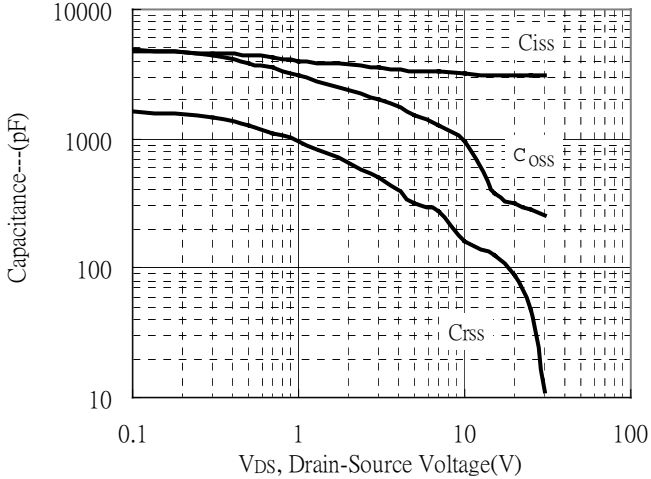

Threshold Voltage vs Junction Temperature

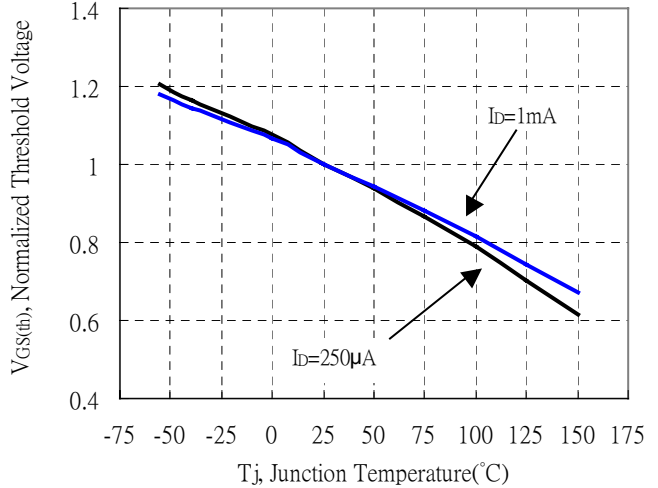

Forward Transfer Admittance vs Drain Current

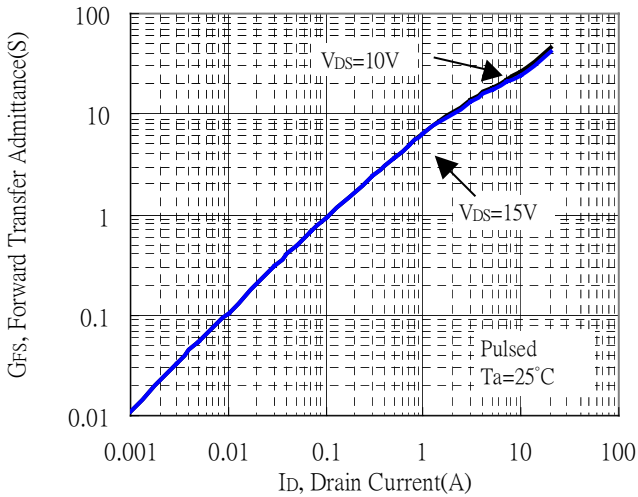

Gate Charge Characteristics

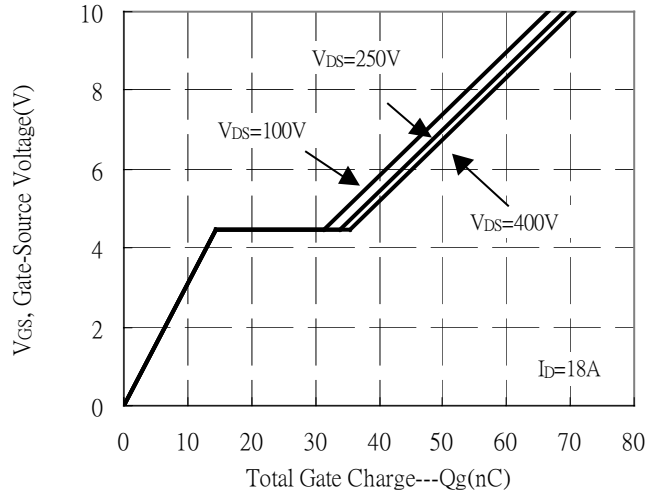

Maximum Safe Operating Area

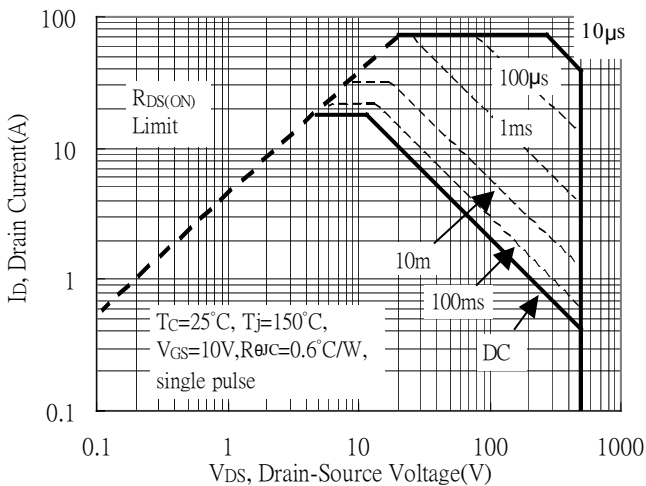

Maximum Drain Current vs Case Temperature

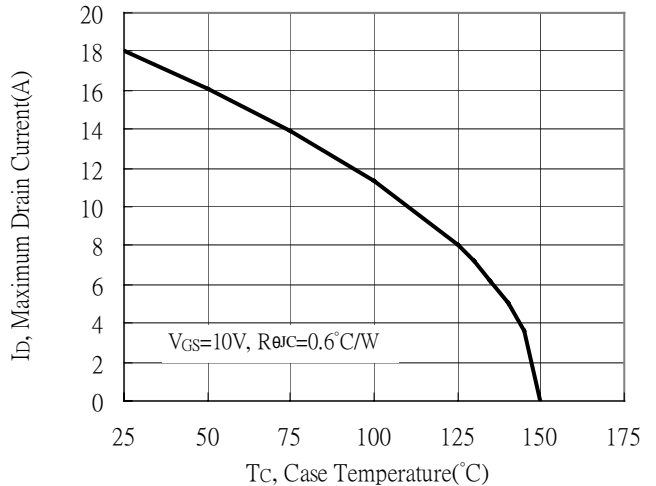

Typical Characteristics(Cont.)

Typical Transfer Characteristics

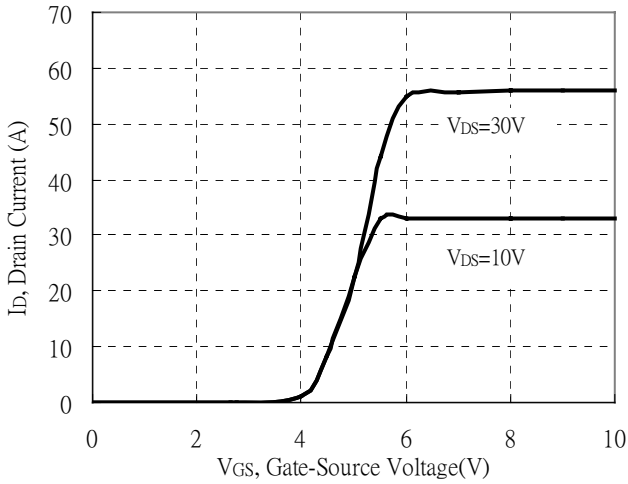

Single Pulse Maximum Power Dissipation

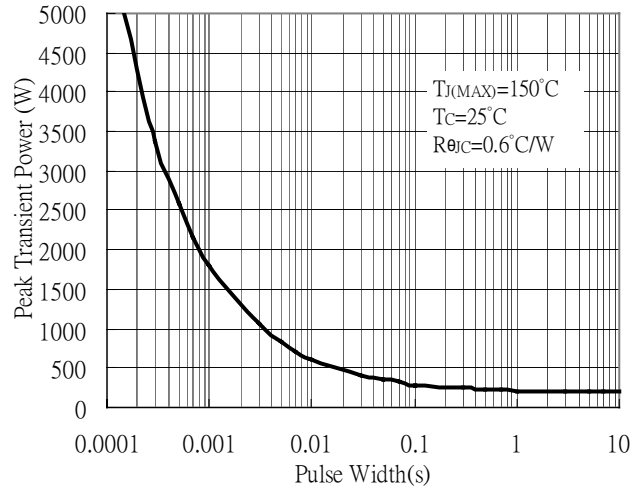

Transient Thermal Response Curves

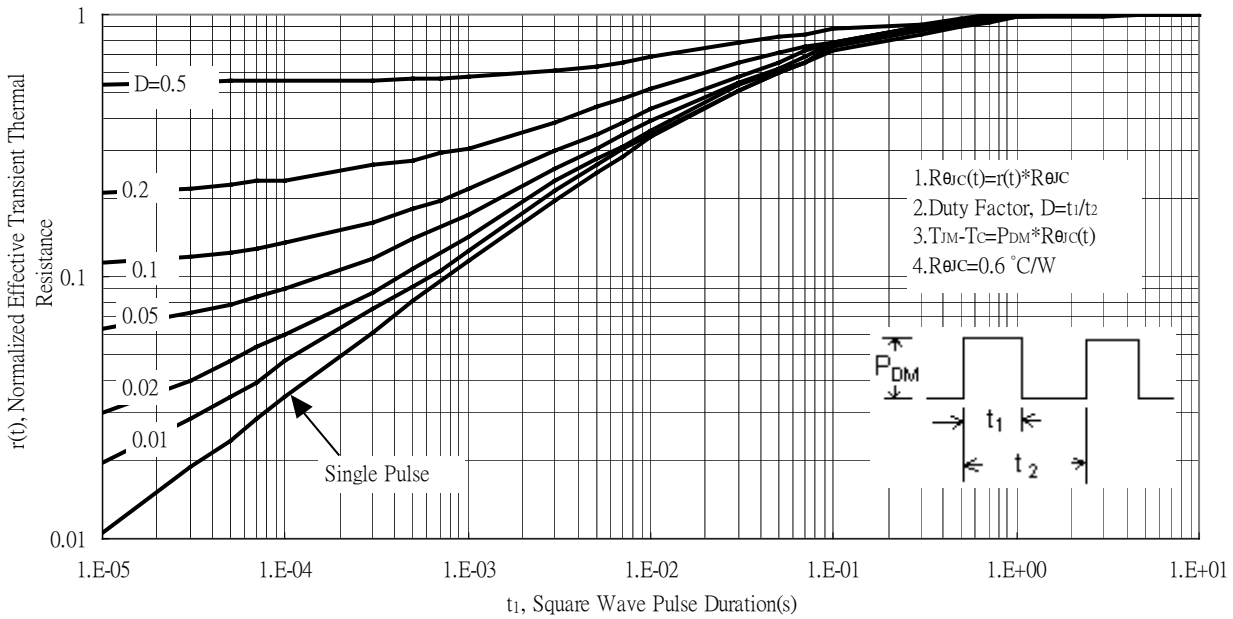

Recommended wave soldering condition

Product	Peak Temperature	Soldering Time
Pb-free devices	260 +0/-5 °C	5 +1/-1 seconds

Recommended temperature profile for IR reflow

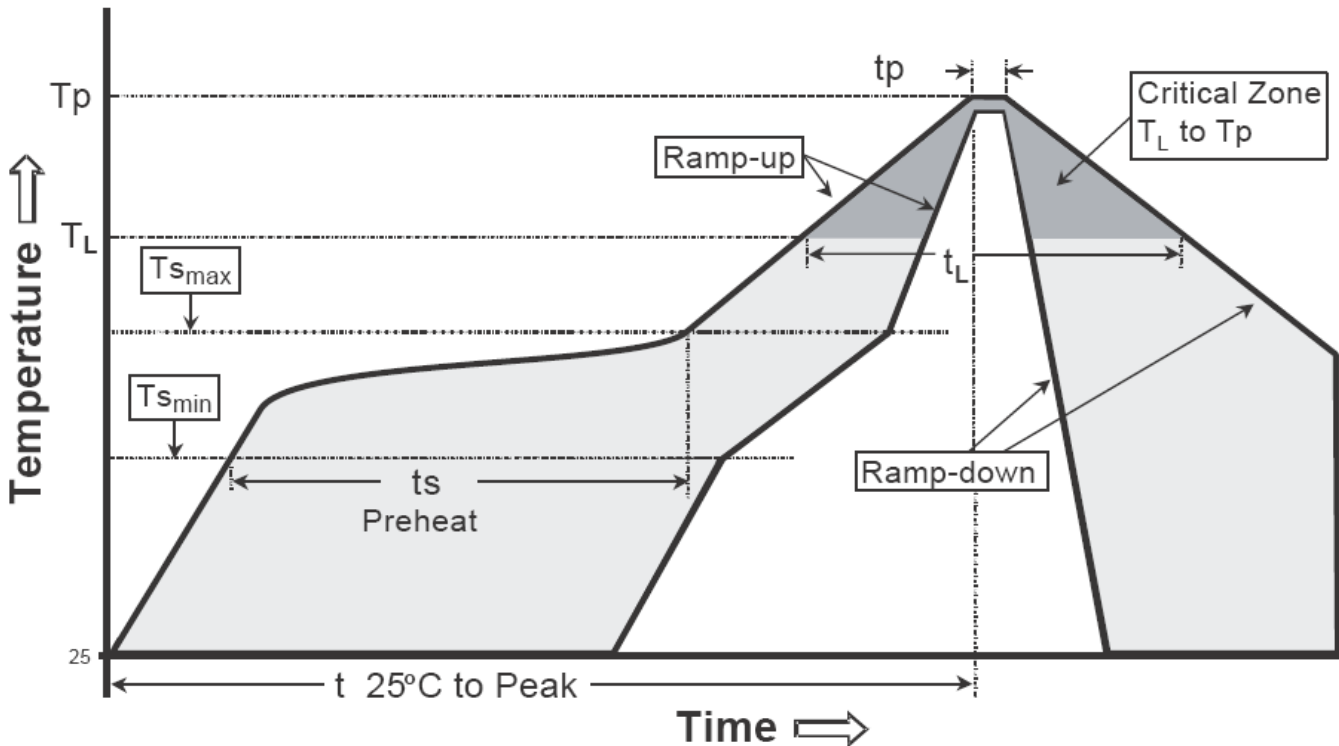

Profile feature	Sn-Pb eutectic Assembly	Pb-free Assembly
Average ramp-up rate (Tsmmax to Tp)	3°C/second max.	3°C/second max.
Preheat		
-Temperature Min(Ts min)	100°C	150°C
-Temperature Max(Ts max)	150°C	200°C
-Time(ts min to ts max)	60-120 seconds	60-180 seconds
Time maintained above:		
-Temperature (Tl)	183°C	217°C
- Time (tl)	60-150 seconds	60-150 seconds
Peak Temperature(Tp)	240 +0/-5 °C	260 +0/-5 °C
Time within 5°C of actual peak temperature(tp)	10-30 seconds	20-40 seconds
Ramp down rate	6°C/second max.	6°C/second max.
Time 25 °C to peak temperature	6 minutes max.	8 minutes max.

Note : All temperatures refer to topside of the package, measured on the package body surface.

TO-220 Dimension

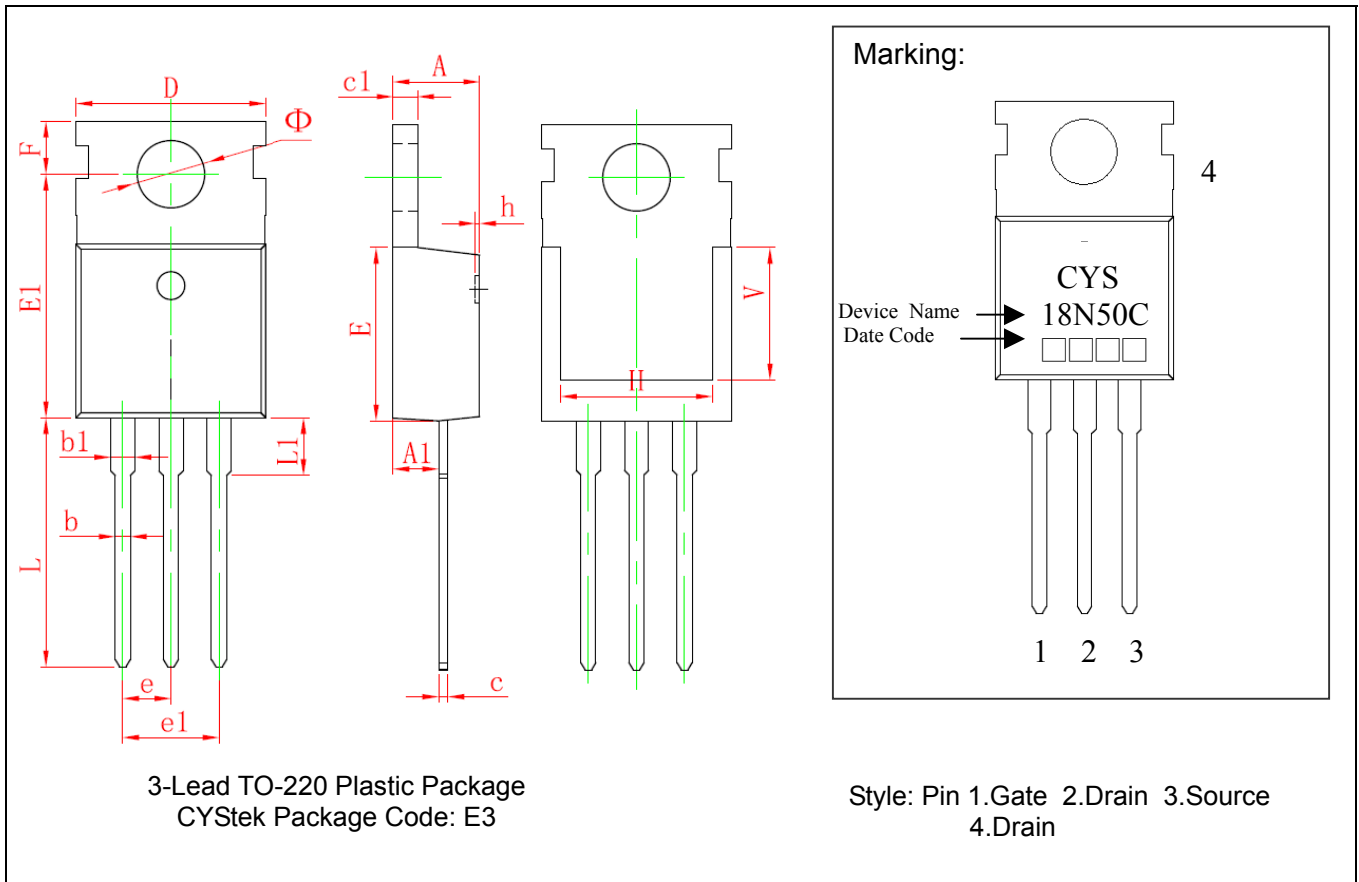

*: Typical

DIM	Millimeters		Inches		DIM	Millimeters		Inches	
	Min.	Max.	Min.	Max.		Min.	Max.	Min.	Max.
A	4.400	4.600	0.173	0.181	e	2.540*		0.100*	
A1	2.250	2.550	0.089	0.100	e1	4.980	5.180	0.196	0.204
b	0.710	0.910	0.028	0.036	F	2.650	2.950	0.104	0.116
b1	1.170	1.370	0.046	0.054	H	7.900	8.100	0.311	0.319
c	0.330	0.650	0.013	0.026	h	0.000	0.300	0.000	0.012
c1	1.200	1.400	0.047	0.055	L	12.900	13.400	0.508	0.528
D	9.910	10.250	0.390	0.404	L1	2.850	3.250	0.112	0.128
E	8.950	9.750	0.352	0.384	V	7/500	REF	0.295	REF
E1	12.650	12.950	0.498	0.510	Φ	3.400	3.800	0.134	0.150

Notes: 1.Controlling dimension: millimeters.
 2.Maximum lead thickness includes lead finish thickness, and minimum lead thickness is the minimum thickness of base material.
 3.If there is any question with packing specification or packing method, please contact your local CYStek sales office.

Material:

- Lead: Pure tin plated.
- Mold Compound: Epoxy resin family, flammability solid burning class: UL94V-0.

Important Notice:

- All rights are reserved. Reproduction in whole or in part is prohibited without the prior written approval of CYStek.
- CYStek reserves the right to make changes to its products without notice.
- CYStek **semiconductor products are not warranted to be suitable for use in Life-Support Applications, or systems.**
- CYStek assumes no liability for any consequence of customer product design, infringement of patents, or application assistance.