

P-Channel Enhancement Mode Power MOSFET

MTEJ0P20KV8

BV _{DSS}	-200V
I _D	-3.9A @ V _{GS} =-10V, T _C =25°C
	-1.3A @ V _{GS} =-10V, T _A =25°C
R _{DSON(Typ)}	0.79Ω @ V _{GS} =-10V, I _D =-1A
	0.84Ω @ V _{GS} =-6V, I _D =-1A

Features

- Simple drive requirement
- Low on-resistance
- Fast switching speed
- G-S ESD protected diode
- Pb-free lead plating and halogen-free package

Equivalent Circuit

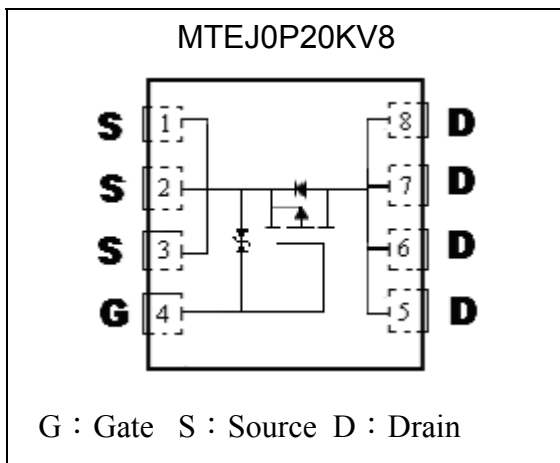

Outline

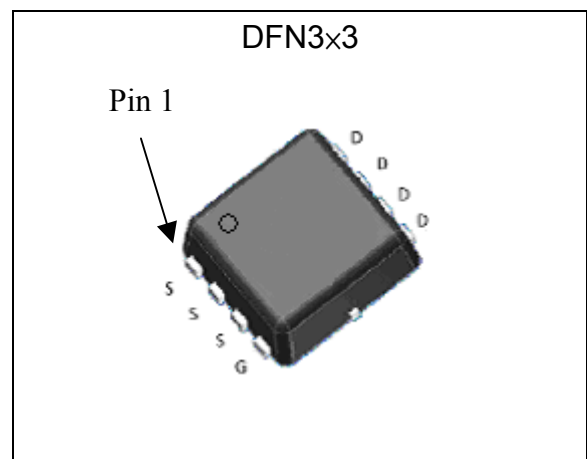

Ordering Information

Device	Package	Shipping
MTEJ0P20KV8-0-T6-G	DFN3x3 (Pb-free lead plating and halogen-free package)	3000 pcs / tape & reel

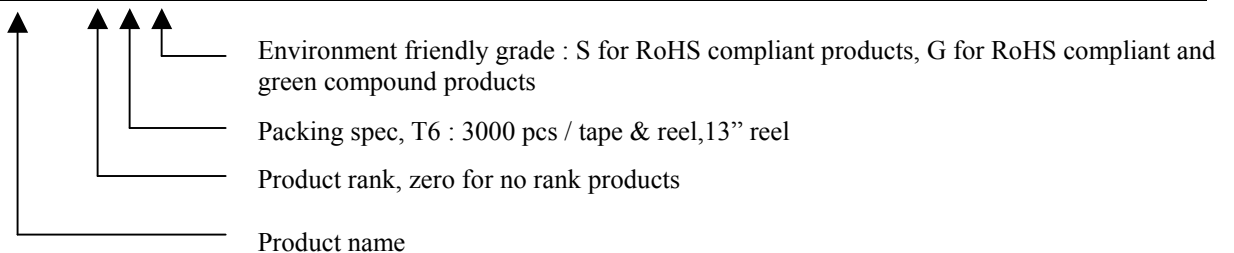



Absolute Maximum Ratings ($T_C=25^{\circ}\text{C}$, unless otherwise noted)

Parameter		Symbol	Limits	Unit	
Drain-Source Voltage		V_{DS}	-200	V	
Gate-Source Voltage		V_{GS}	± 20		
Continuous Drain Current @ $T_C=25^{\circ}\text{C}$, $V_{GS}=-10\text{V}$		I_D	-3.9	A	
Continuous Drain Current @ $T_C=70^{\circ}\text{C}$, $V_{GS}=-10\text{V}$			-3.1		
Continuous Drain Current @ $T_A=25^{\circ}\text{C}$, $V_{GS}=-10\text{V}$ *3, 4			-1.3		
Continuous Drain Current @ $T_A=70^{\circ}\text{C}$, $V_{GS}=-10\text{V}$ *3, 4			-1.0		
Pulsed Drain Current *1, 2		I_{DM}	-8.0		
Continuous Source-Drain Diode Current	$T_C=25^{\circ}\text{C}$	I_S	-5		
	$T_A=25^{\circ}\text{C}$		-3		
Avalanche Current		I_{AS}	-4		
Avalanche Energy @ $L=4\text{mH}$, $I_D=-4\text{A}$, $R_G=25\ \Omega$		E_{AS}	32		mJ
Maximum Power Dissipation	$T_C=25^{\circ}\text{C}$	P_D	33		W
	$T_C=70^{\circ}\text{C}$		21		
	$T_A=25^{\circ}\text{C}$ *3, 4		3.6		
	$T_A=70^{\circ}\text{C}$ *3, 4		2.3		
Operating Junction and Storage Temperature Range		T_j, T_{stg}	-55~+150	$^{\circ}\text{C}$	

Thermal Data

Parameter	Symbol	Typ	Maximum	Unit
Thermal Resistance, Junction-to-ambient *3	$R_{th,j-a}$	$t \leq 10\text{s}$	28	$^{\circ}\text{C}/\text{W}$
		Steady State	65	
Thermal Resistance, Junction-to-case	$R_{th,j-c}$	2.9	3.8	

- Note :
1. Pulse width limited by maximum junction temperature.
 2. Duty cycle $\leq 1\%$.
 3. Surface mounted on 1 in² copper pad of FR-4 board.
 4. $t \leq 10\text{s}$.
 5. 100% tested by conditions of $L=2\text{mH}$, $V_{GS}=-10\text{V}$, $I_{AS}=-4\text{A}$, $V_{DD}=-25\text{V}$



Characteristics (Tc=25°C, unless otherwise specified)

Symbol	Min.	Typ.	Max.	Unit	Test Conditions
Static					
BV _{DSS}	-200	-	-	V	V _{GS} =0V, I _D =-250μA
ΔBV _{DSS} /T _J	-	-150	-	mV/°C	I _D =-250μA
ΔV _{GS(th)} /T _J	-	-6	-		
V _{GS(th)}	-2	-	-4	V	V _{DS} =V _{GS} , I _D =-250μA
I _{GSS}	-	-	±10	μA	V _{GS} =±16V, V _{DS} =0V
I _{DSS}	-	-	-1		V _{DS} =-180V, V _{GS} =0V
	-	-	-10		V _{DS} =-180V, V _{GS} =0V, T _J =55°C
R _{DS(ON)} *1	-	0.79	1.0	Ω	V _{GS} =-10V, I _D =-1A
	-	0.84	1.1		V _{GS} =-6V, I _D =-1A
G _{FS} *1	-	2.7	-	S	V _{DS} =-15V, I _D =-1A
Dynamic					
Q _g (V _{GS} =-10V) *1, 2	-	13.1	20	nC	V _{DS} =-100V, I _D =-1A, V _{GS} =-10V
Q _g (V _{GS} =-6V) *1, 2	-	8.7	13		
Q _{gs} *1, 2	-	2.3	-		
Q _{gd} *1, 2	-	3.6	-		
t _{d(ON)} *1, 2	-	92	138	ns	V _{DS} =-100V, I _D =-1A, V _{GS} =-10V, R _G =1 Ω
t _r *1, 2	-	36.4	54.6		
t _{d(OFF)} *1, 2	-	298	447		
t _f *1, 2	-	551	827		
C _{iss}	-	519	-	pF	V _{DS} =-30V, V _{GS} =0V, f=1MHz
C _{oss}	-	40	-		
C _{rss}	-	7.3	-		
Source-Drain Diode					
I _S *1	-	-	-5	A	T _C =25°C
I _{SM} *3	-	-	-5		
V _{SD} *1	-	-0.79	-1.2	V	I _F =-1A, V _{GS} =0V
t _{rr}	-	68	100	ns	I _F =-4A, dI _F /dt=100A/μs
Q _{rr}	-	177	266	nC	
t _a		50		ns	
t _b		18			

Note : *1.Pulse Test : Pulse Width ≤300μs, Duty Cycle≤2%
 *2.Independent of operating temperature
 *3.Pulse width limited by maximum junction temperature.

Recommended Soldering Footprint

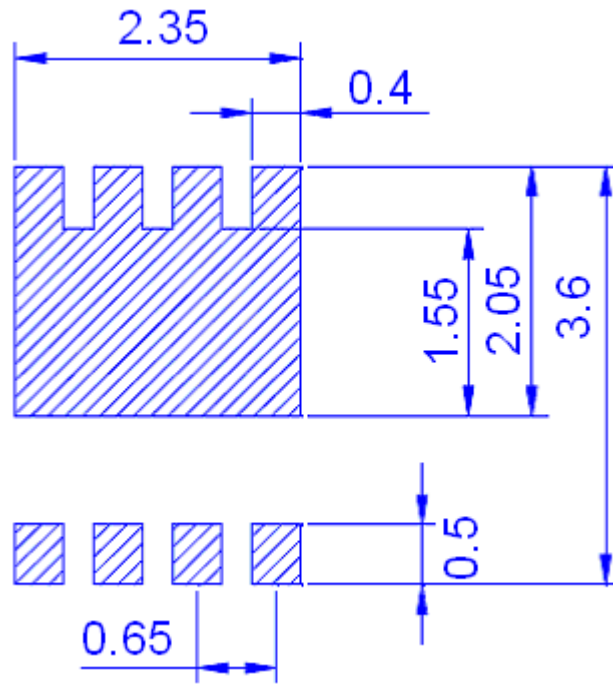

unit : mm



Typical Characteristics

Typical Output Characteristics

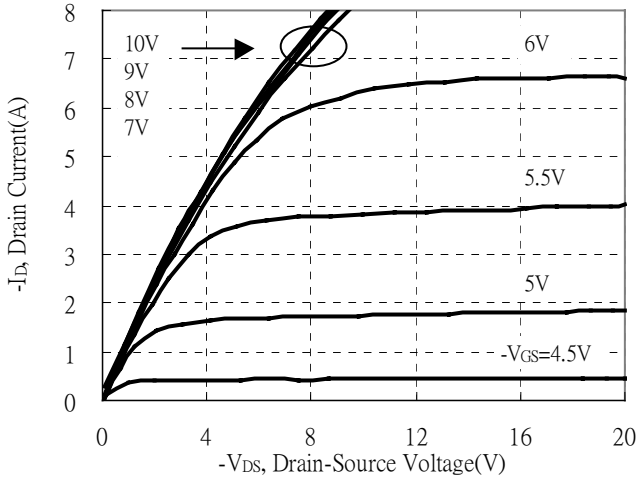

Brekdown Voltage vs Ambient Temperature

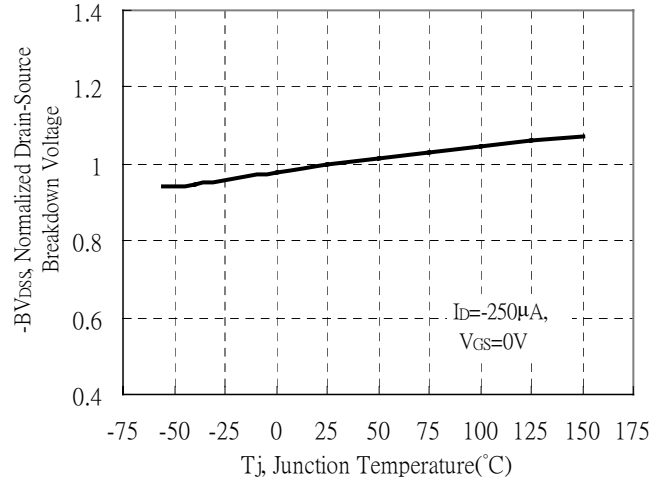

Static Drain-Source On-State resistance vs Drain Current

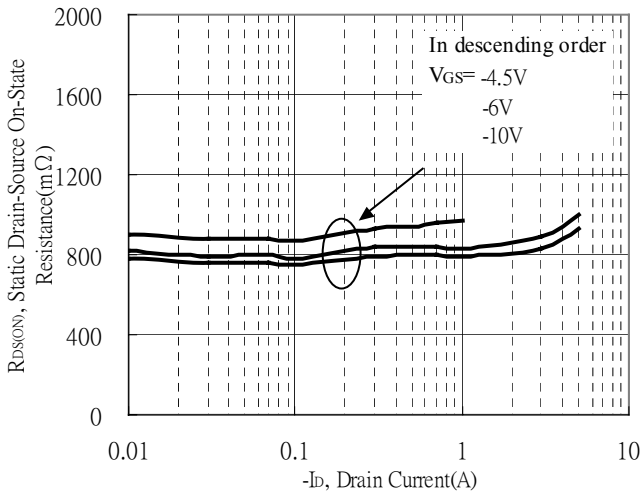

Reverse Drain Current vs Source-Drain Voltage

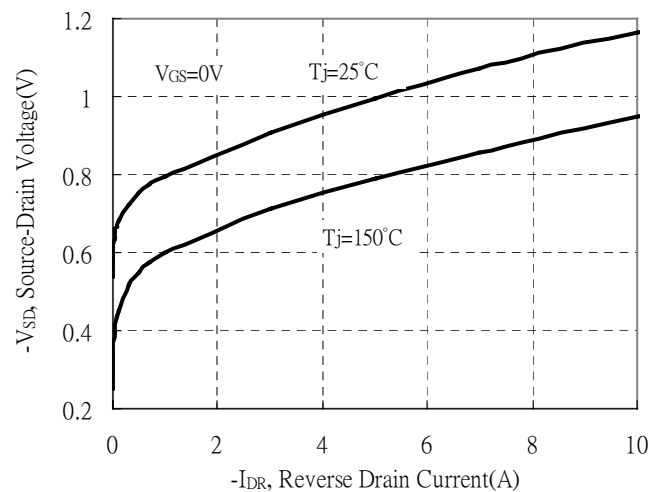

Static Drain-Source On-State Resistance vs Gate-Source Voltage

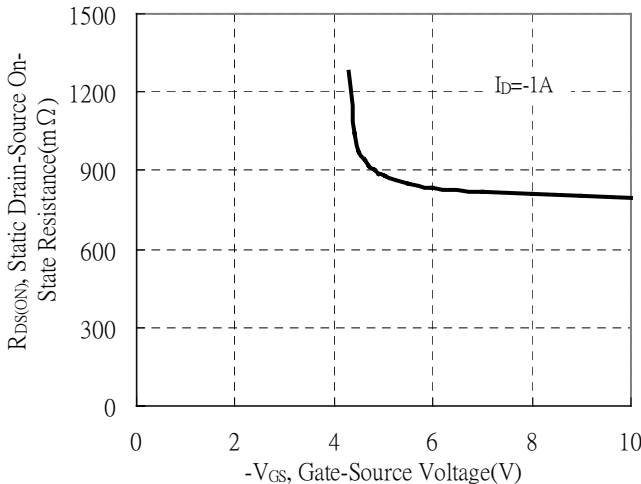

Drain-Source On-State Resistance vs Junction Temperature

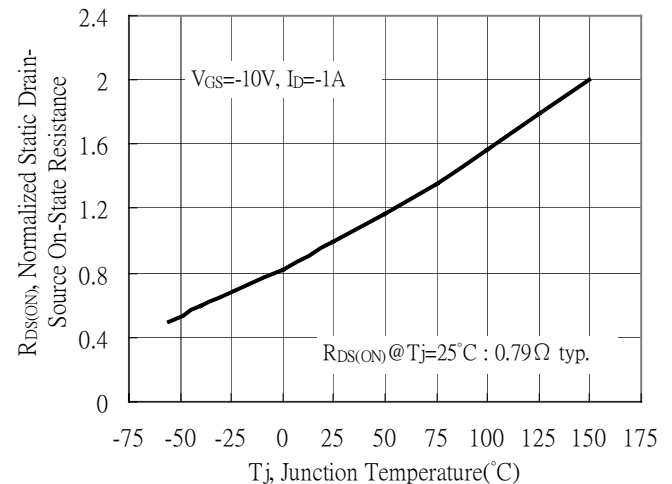

Typical Characteristics(Cont.)

Capacitance vs Drain-to-Source Voltage

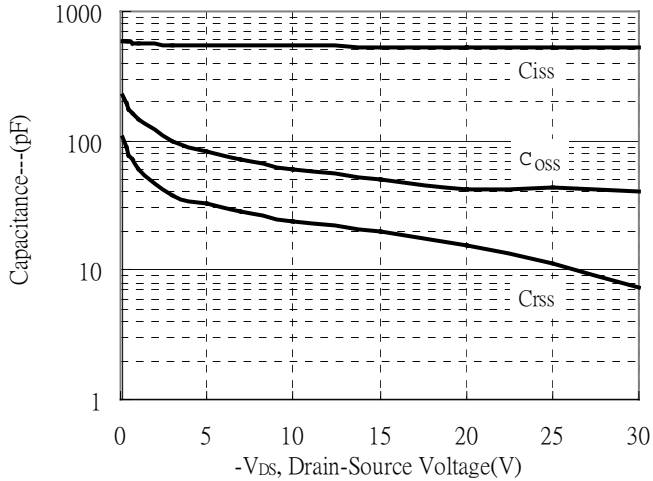

Threshold Voltage vs Junction Temperature

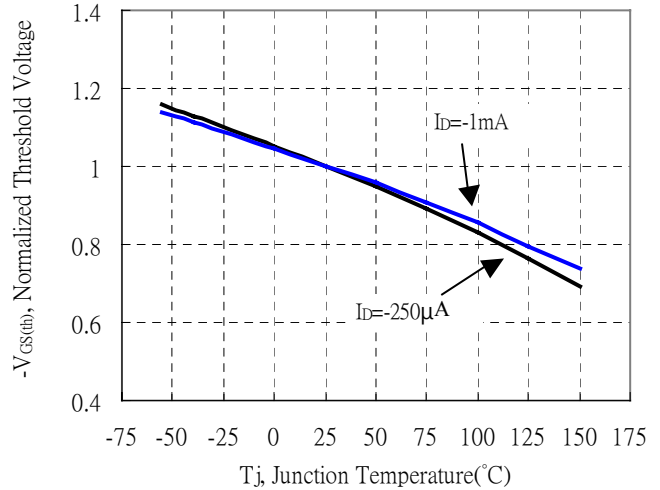

Maximum Safe Operating Area

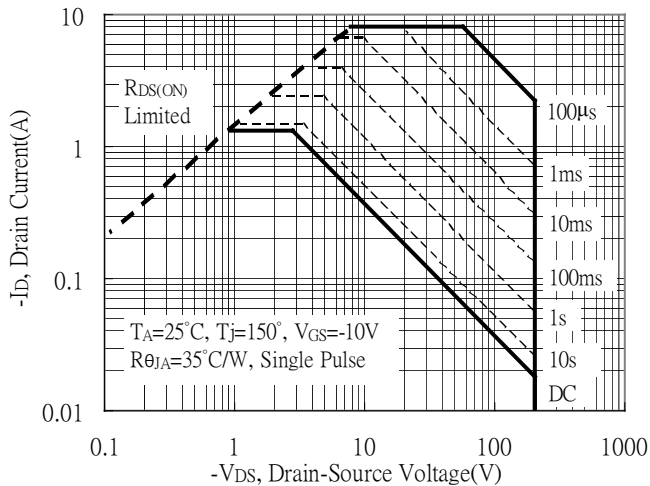

Gate Charge Characteristics

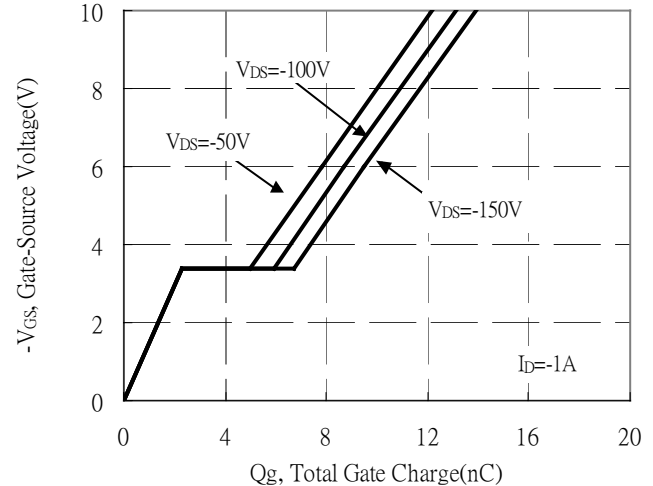

Maximum Drain Current vs Junction Temperature

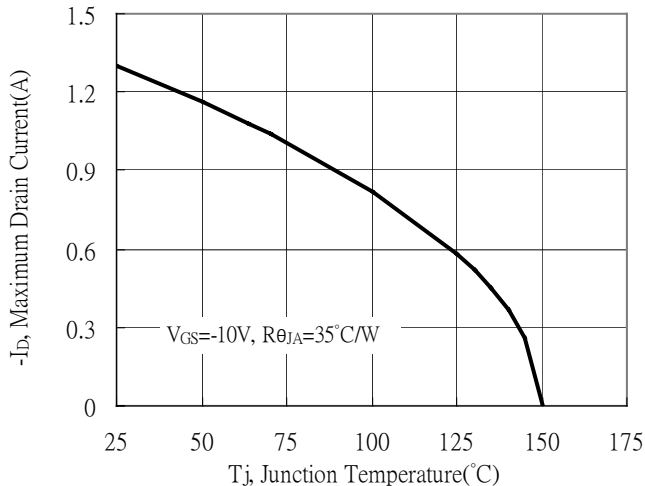

Typical Transfer Characteristics

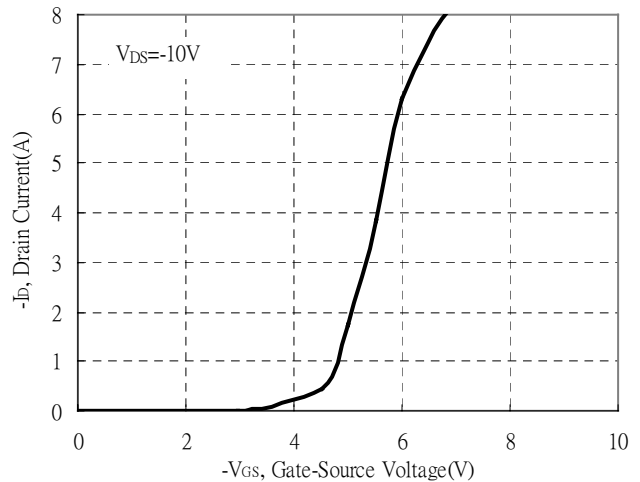



Typical Characteristics(Cont.)

Forward Transfer Admittance vs Drain Current

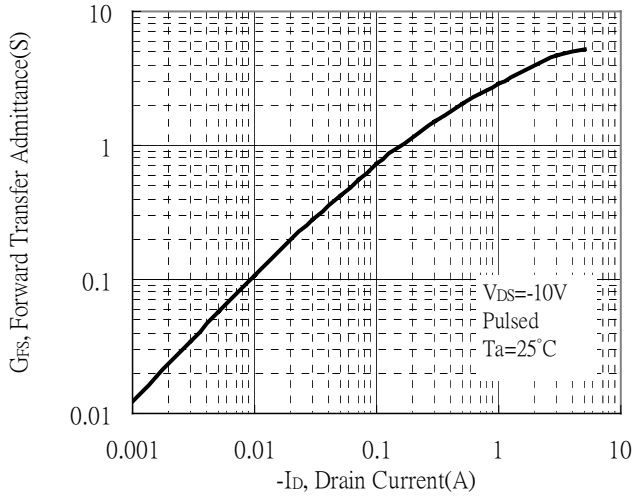

Power Derating Curve

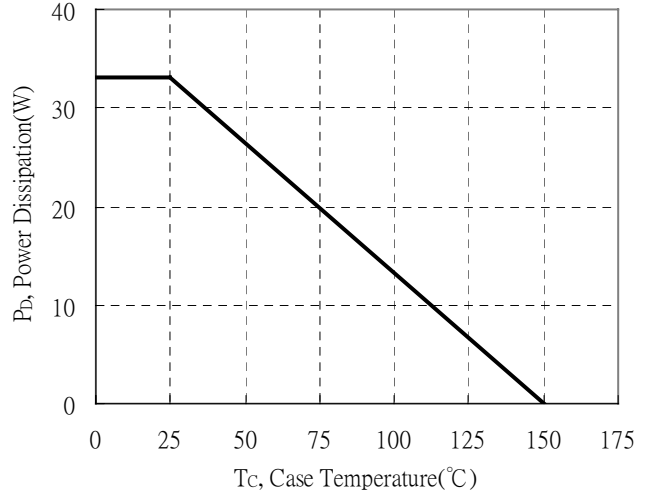

Transient Thermal Response Curves

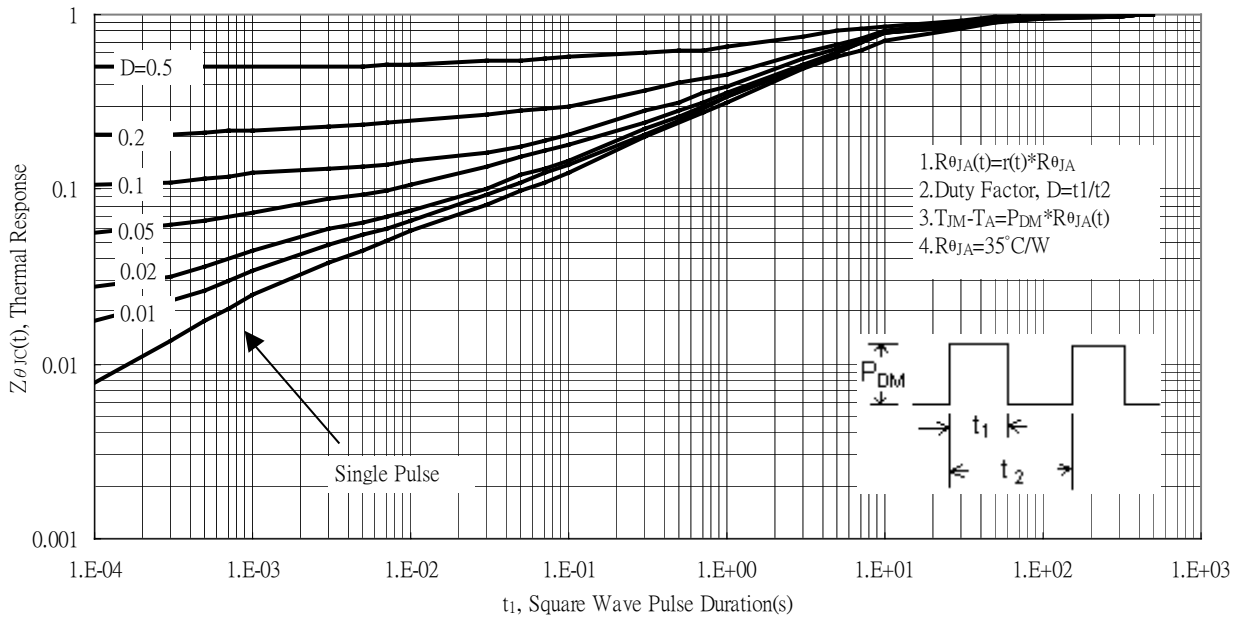

Reel Dimension

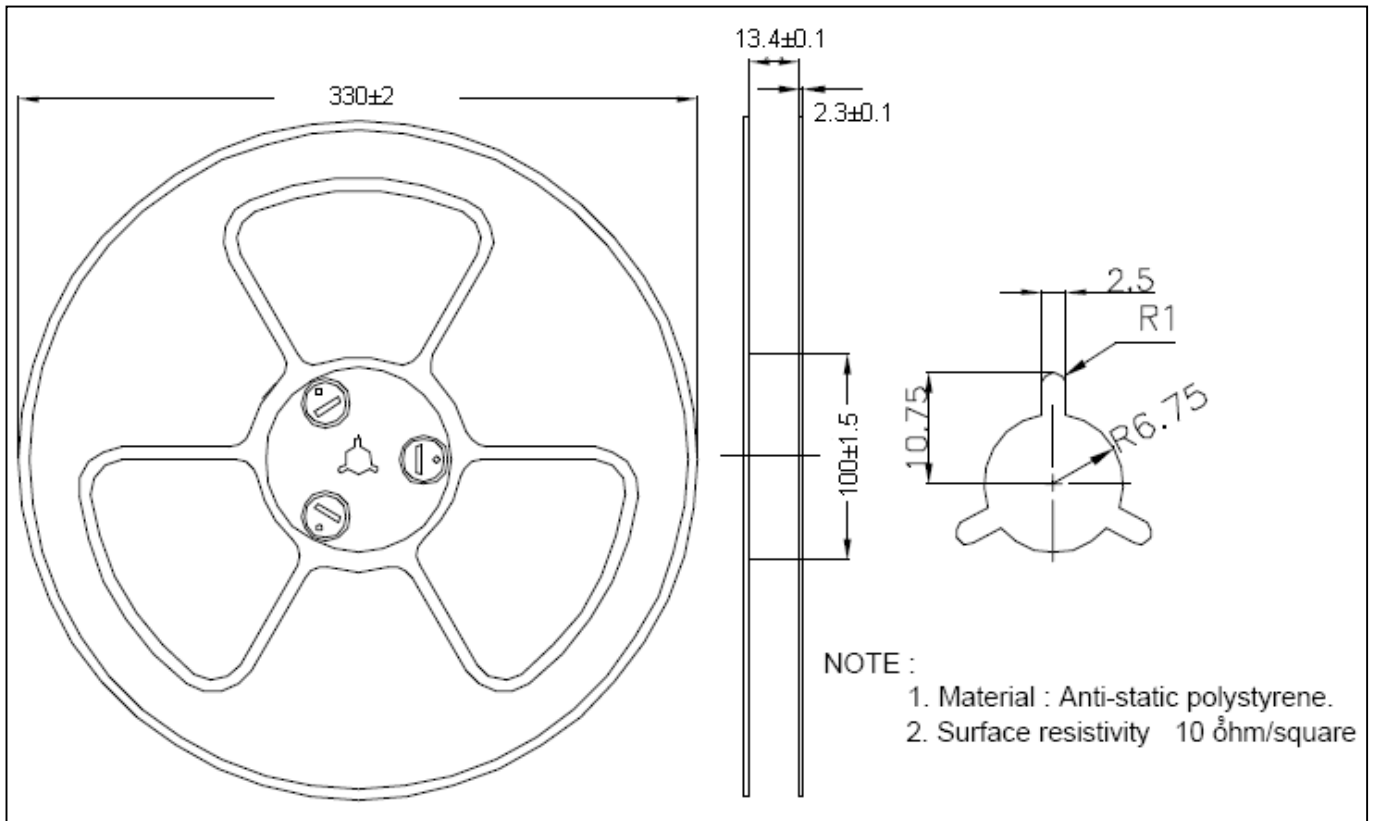

Carrier Tape Dimension

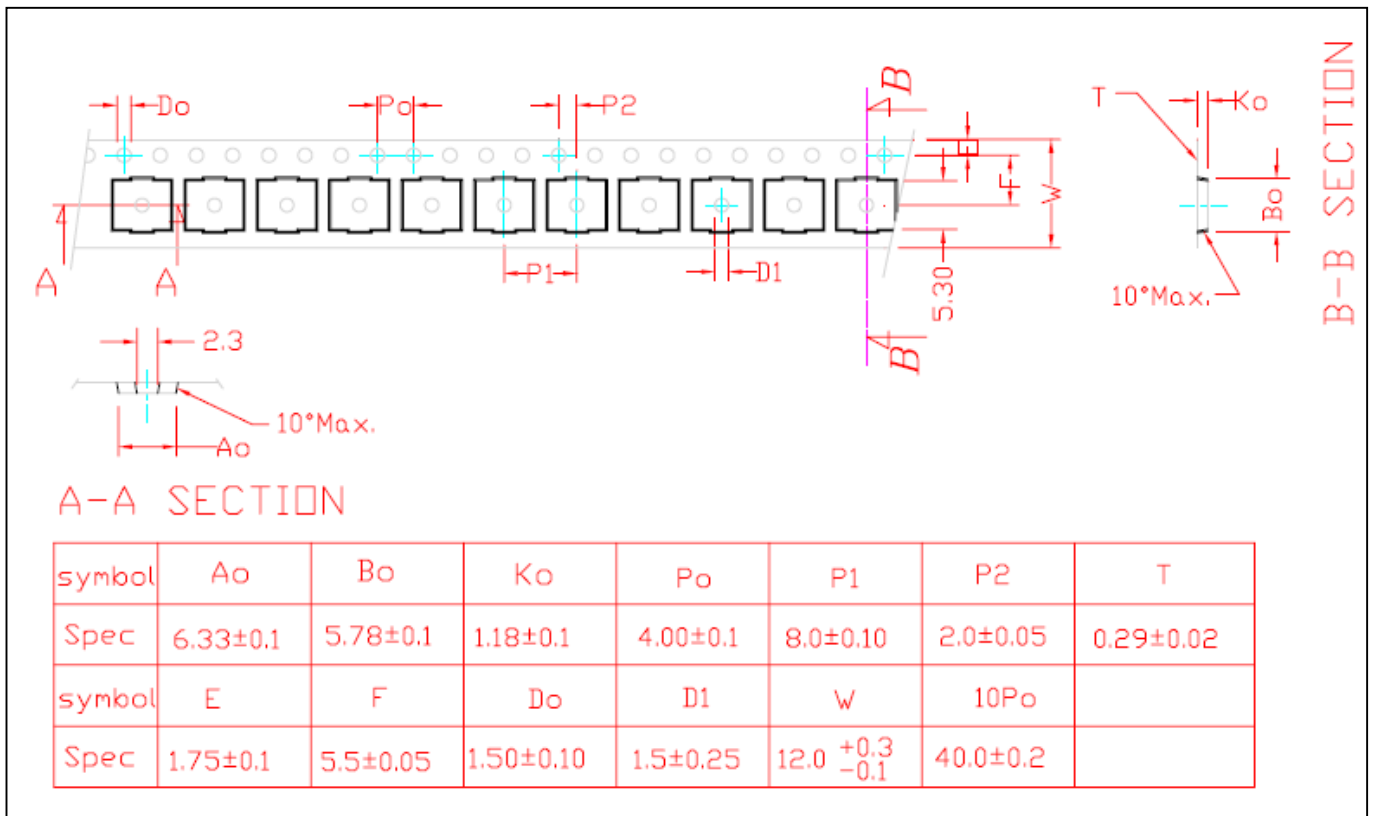

Recommended wave soldering condition

Product	Peak Temperature	Soldering Time
Pb-free devices	260 +0/-5 °C	5 +1/-1 seconds

Recommended temperature profile for IR reflow

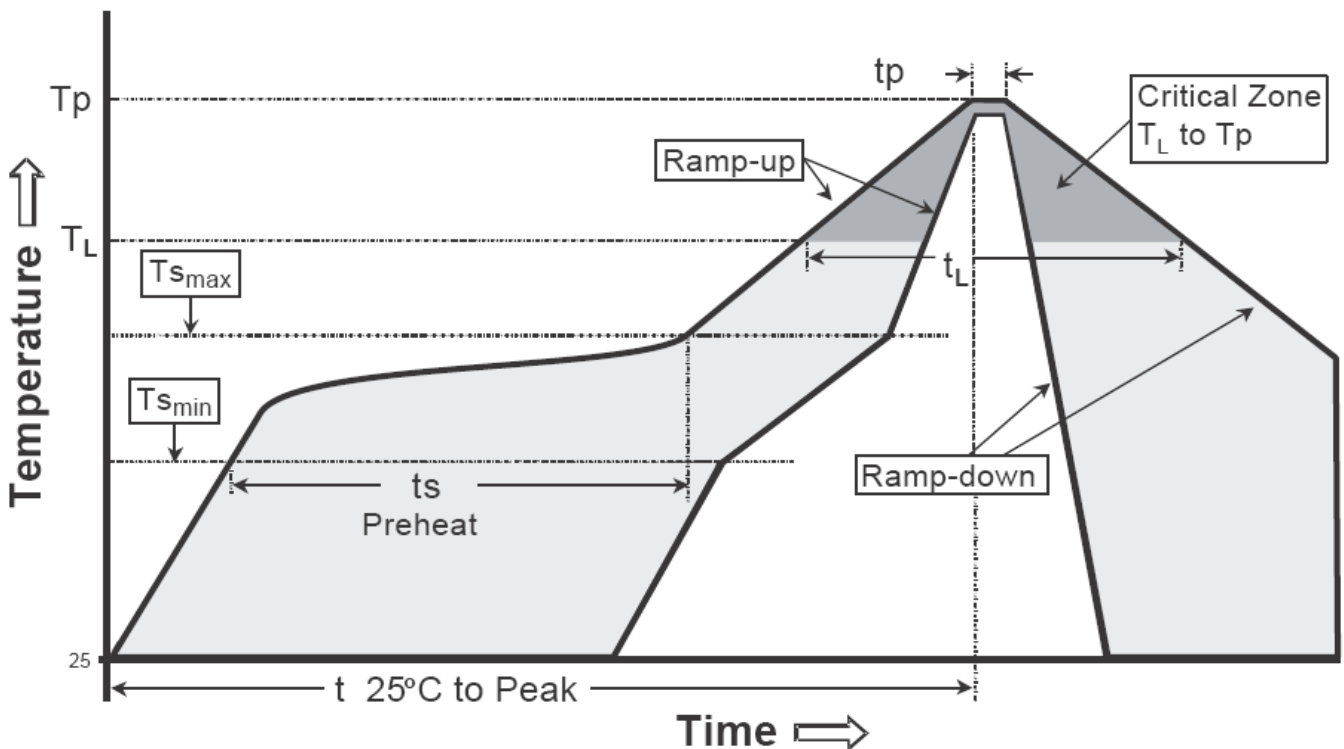

Profile feature	Sn-Pb eutectic Assembly	Pb-free Assembly
Average ramp-up rate (T _{smax} to T _p)	3°C/second max.	3°C/second max.
Preheat		
-Temperature Min(T _{s min})	100°C	150°C
-Temperature Max(T _{s max})	150°C	200°C
-Time(t _{s min} to t _{s max})	60-120 seconds	60-180 seconds
Time maintained above:		
-Temperature (T _L)	183°C	217°C
- Time (t _L)	60-150 seconds	60-150 seconds
Peak Temperature(T _P)	240 +0/-5 °C	260 +0/-5 °C
Time within 5°C of actual peak temperature(t _p)	10-30 seconds	20-40 seconds
Ramp down rate	6°C/second max.	6°C/second max.
Time 25 °C to peak temperature	6 minutes max.	8 minutes max.

Note : All temperatures refer to topside of the package, measured on the package body surface.

DFN3x3 Dimension

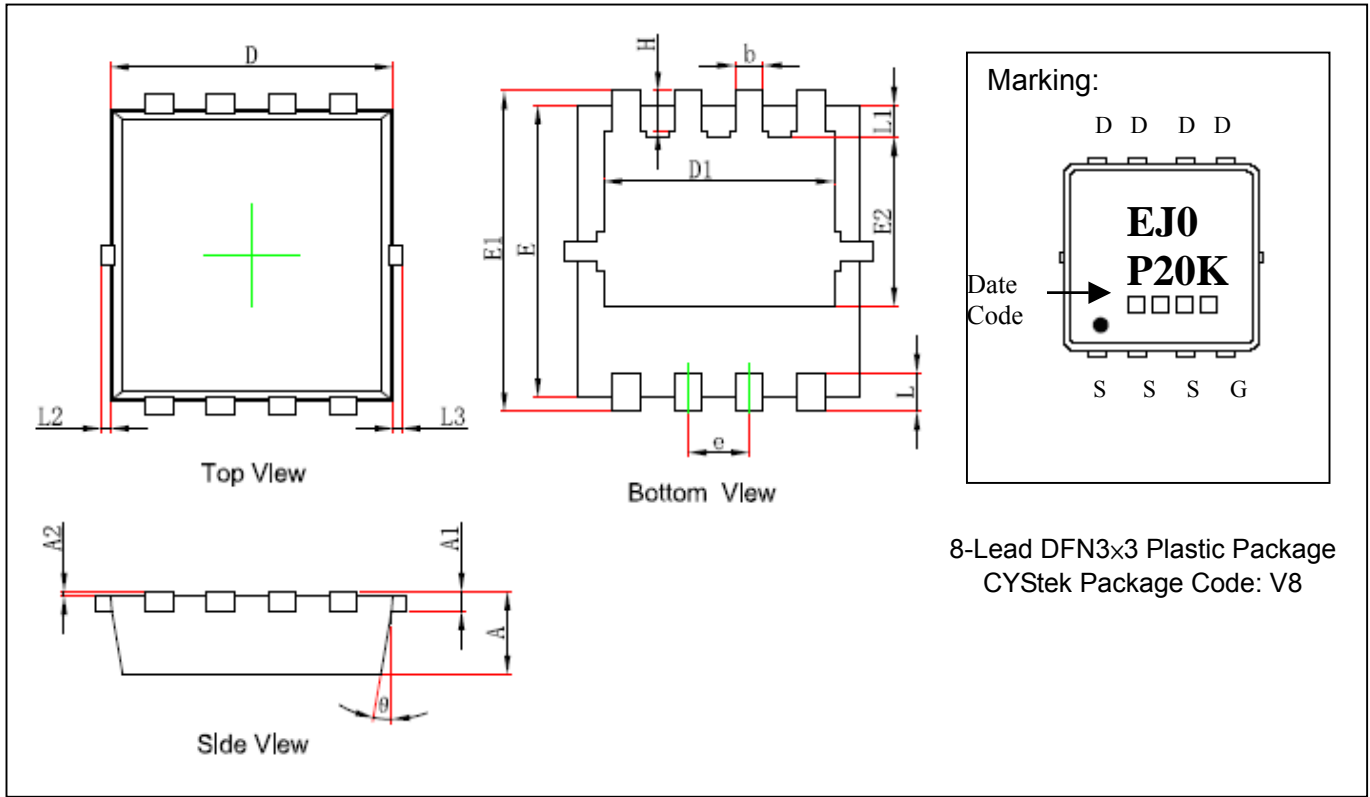

*: Typical

DIM	Millimeters		Inches		DIM	Millimeters		Inches	
	Min.	Max.	Min.	Max.		Min.	Max.	Min.	Max.
A	0.605	0.850	0.026	0.033	b	0.200	0.400	0.008	0.016
A1	0.152	REF	0.006	REF	e	0.550	0.750	0.022	0.030
A2	0.000	0.050	0.000	0.002	L	0.300	0.500	0.012	0.020
D	2.900	3.100	0.114	0.122	L1	0.180	0.480	0.007	0.019
D1	2.300	2.600	0.091	0.102	L2	0.000	0.100	0.000	0.004
E	2.900	3.100	0.114	0.122	L3	0.000	0.100	0.000	0.004
E1	3.150	3.450	0.124	0.136	H	0.315	0.515	0.012	0.020
E2	1.535	1.935	0.060	0.076	θ	9°	13°	9°	13°

Notes: 1. Controlling dimension: millimeters.
 2. Maximum lead thickness includes lead finish thickness, and minimum lead thickness is the minimum thickness of base material.
 3. If there is any question with packing specification or packing method, please contact your local CYStek sales office.

Material:

- Lead: pure tin plated.
- Mold Compound: Epoxy resin family, flammability solid burning class: UL94V-0.

Important Notice:

- All rights are reserved. Reproduction in whole or in part is prohibited without the prior written approval of CYStek.
- CYStek reserves the right to make changes to its products without notice.
- CYStek **semiconductor products are not warranted to be suitable for use in Life-Support Applications, or systems.**
- CYStek assumes no liability for any consequence of customer product design, infringement of patents, or application assistance.