

# P-Channel Enhancement Mode Power MOSFET

## MTEF1P15AN6

### Description

The MTEF1P15AN6 is a P-channel enhancement-mode MOSFET, providing the designer with the best combination of fast switching, ruggedized device design, low on-resistance and cost effectiveness. The SOT-26 package is universally preferred for all commercial-industrial surface mount applications.

### Features

- Simple drive requirement
- Low on-resistance
- Small package outline
- Pb-free lead plating and halogen-free package

### Equivalent Circuit

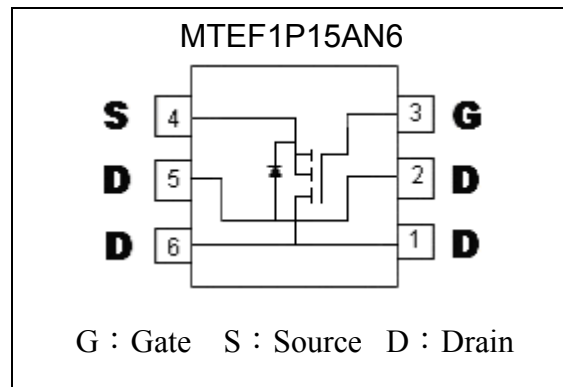

### Absolute Maximum Ratings (Ta=25°C)

Parameter		Symbol	Limits	Unit
Drain-Source Voltage		V <sub>DS</sub>	-150	V
Gate-Source Voltage		V <sub>GS</sub>	±20	
Continuous Drain Current	T <sub>C</sub> =25 °C	I <sub>D</sub>	-1.7	A
	T <sub>C</sub> =70 °C		-1.4	
	T <sub>A</sub> =25 °C (Note 1)		-1.3	
	T <sub>A</sub> =70 °C (Note 1)		-1.0	
Pulsed Drain Current (Note 2, 3)		I <sub>DM</sub>	-6.8	
Total Power Dissipation	T <sub>C</sub> =25 °C	P <sub>D</sub>	3.2	W
	T <sub>C</sub> =70 °C		2.1	
	T <sub>A</sub> =25 °C		2	
	T <sub>A</sub> =70 °C		1.25	
Operating Junction Temperature and Storage Temperature Range		T <sub>j</sub> , T <sub>stg</sub>	-55~+150	°C

### Thermal Data

Parameter	Symbol	Value	Unit
Thermal Resistance, Junction-to-case, max	R <sub>th,j-c</sub>	39	°C/W
Thermal Resistance, Junction-to-ambient, max (Note 1)	R <sub>θJA</sub>	62.5	



Note : 1.Surface mounted on 1 in<sup>2</sup> copper pad of FR-4 board, t<sub>5</sub> sec. 156°C/W when mounted on minimum copper pad.  
 2.Pulse width limited by maximum junction temperature.  
 3.Pulse Width ≤300μs, Duty Cycles≤2%

**Electrical Characteristics (Ta=25°C, unless otherwise noted)**

Symbol	Min.	Typ.	Max.	Unit	Test Conditions
<b>Static</b>					
BV <sub>DSS</sub>	-150	-	-	V	V <sub>GS</sub> =0, I <sub>D</sub> =-250μA
ΔBV <sub>DSS</sub> /ΔT <sub>j</sub>	-	-0.1	-	V/°C	Reference to 25°C, I <sub>D</sub> =-250μA
V <sub>GS(th)</sub>	-2	-2.9	-4	V	V <sub>DS</sub> =V <sub>GS</sub> , I <sub>D</sub> =-250μA
I <sub>GSS</sub>	-	-	±100	nA	V <sub>GS</sub> =±20V, V <sub>DS</sub> =0
I <sub>DSS</sub>	-	-	-100		V <sub>DS</sub> =-120V, V <sub>GS</sub> =0, T <sub>j</sub> =25°C
	-	-	-10	μA	V <sub>DS</sub> =-120V, V <sub>GS</sub> =0, T <sub>j</sub> =55°C
*R <sub>DSON</sub>	-	554	820	mΩ	I <sub>D</sub> =-1.4A, V <sub>GS</sub> =-10V
	-	585	850		I <sub>D</sub> =-1A, V <sub>GS</sub> =-6V
*G <sub>FS</sub>	-	2.9	-	S	V <sub>DS</sub> =-10V, I <sub>D</sub> =-1.4A
<b>Dynamic</b>					
C <sub>iss</sub>	-	571	-	pF	V <sub>DS</sub> =-30V, V <sub>GS</sub> =0, f=1MHz
C <sub>oss</sub>	-	29	-		
C <sub>rss</sub>	-	17	-		
t <sub>d(ON)</sub>	-	9	-	ns	V <sub>DS</sub> =-75V, I <sub>D</sub> =-1A, V <sub>GS</sub> =-10V, R <sub>G</sub> =1Ω
t <sub>r</sub>	-	6	-		
t <sub>d(OFF)</sub>	-	23	-		
t <sub>f</sub>	-	8	-		
Q <sub>g</sub>	-	11	-	nC	V <sub>DS</sub> =-75V, I <sub>D</sub> =-1A, V <sub>GS</sub> =-10V
Q <sub>gs</sub>	-	2.5	-		
Q <sub>gd</sub>	-	2.4	-		
<b>Source-Drain Diode</b>					
*I <sub>S</sub>	-	-	-1.7	A	
*I <sub>SM</sub>	-	-	-6.8		
*V <sub>SD</sub>	-	-0.77	-1.2	V	I <sub>S</sub> =-1A, V <sub>GS</sub> =0V
*T <sub>rr</sub>	-	60	-	ns	I <sub>S</sub> =-1A, V <sub>GS</sub> =0V, dI/dt=100A/μs
Q <sub>rr</sub>	-	120	-	nC	

\*Pulse Test : Pulse Width ≤300μs, Duty Cycle≤2%

**Ordering Information**

Device	Package	Shipping
MTEF1P15AN6-0-T1-G	SOT-26 (Pb-free lead plating and halogen-free package)	3000 pcs / Tape & Reel

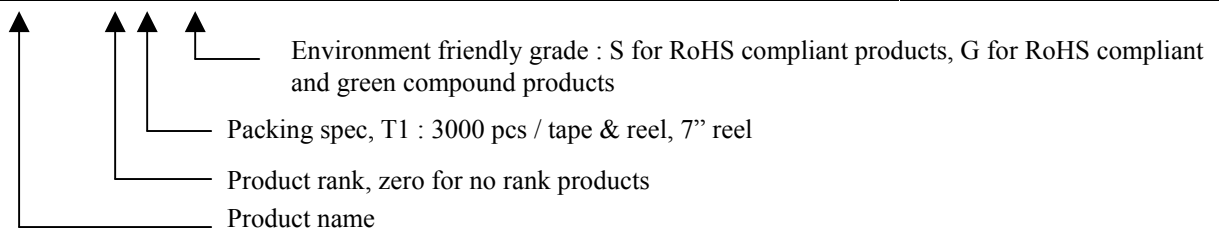

**Typical Characteristics**

Typical Output Characteristics

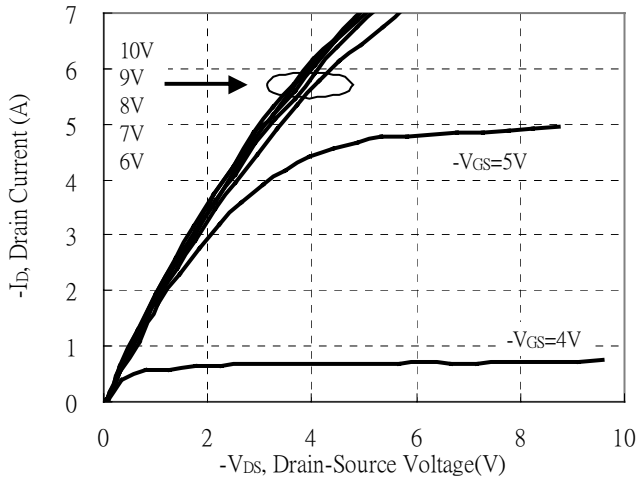

Brekdown Voltage vs Ambient Temperature

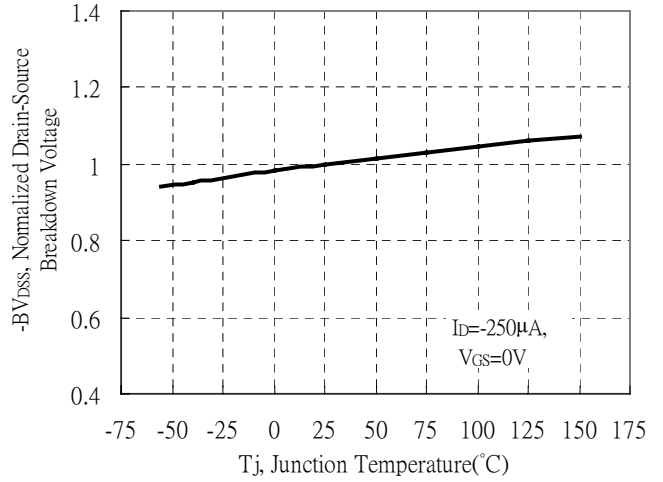

Static Drain-Source On-State resistance vs Drain Current

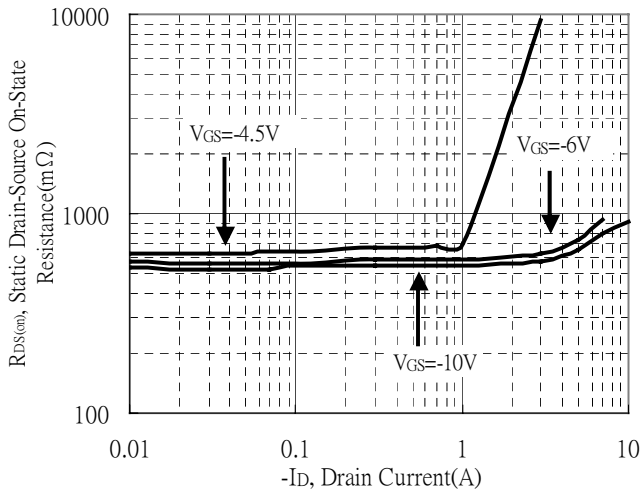

Reverse Drain Current vs Source-Drain Voltage

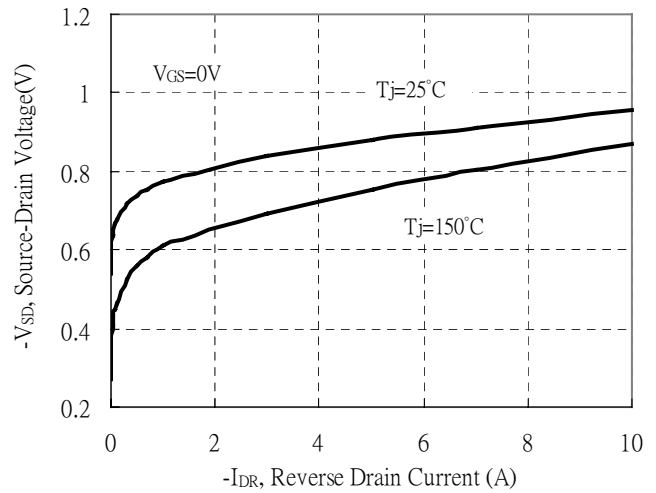

Static Drain-Source On-State Resistance vs Gate-Source Voltage

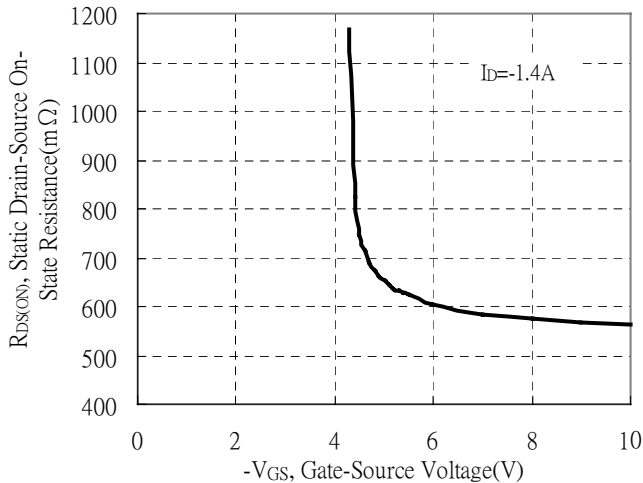

Drain-Source On-State Resistance vs Junction Temperature

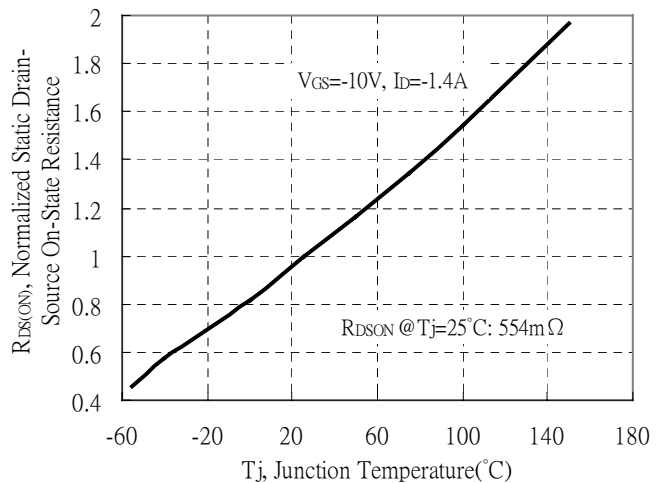

**Typical Characteristics(Cont.)**

Capacitance vs Drain-to-Source Voltage

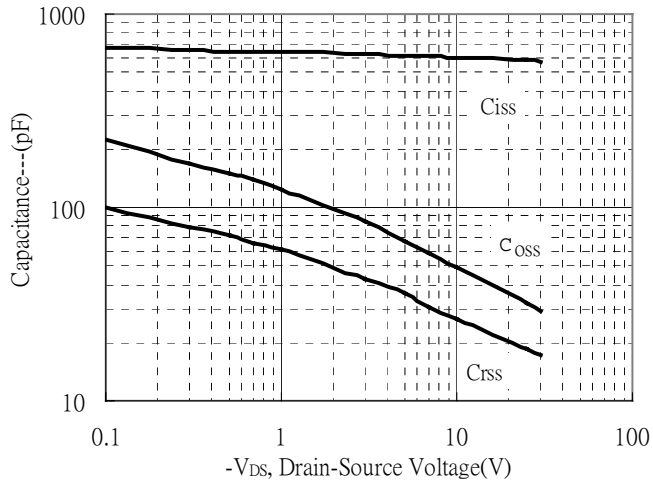

Threshold Voltage vs Junction Temperature

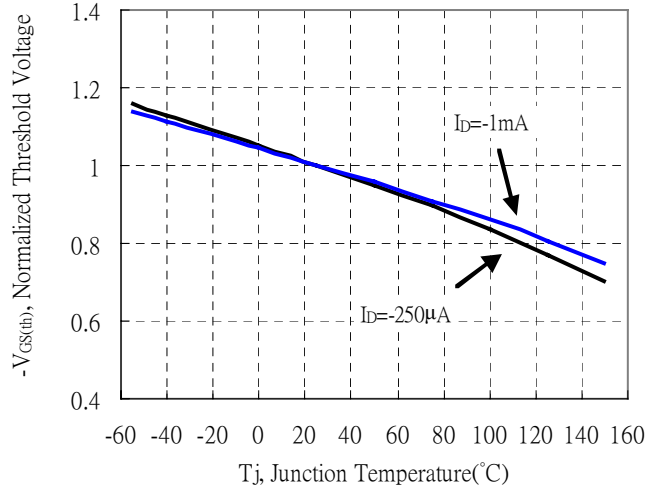

Forward Transfer Admittance vs Drain Current

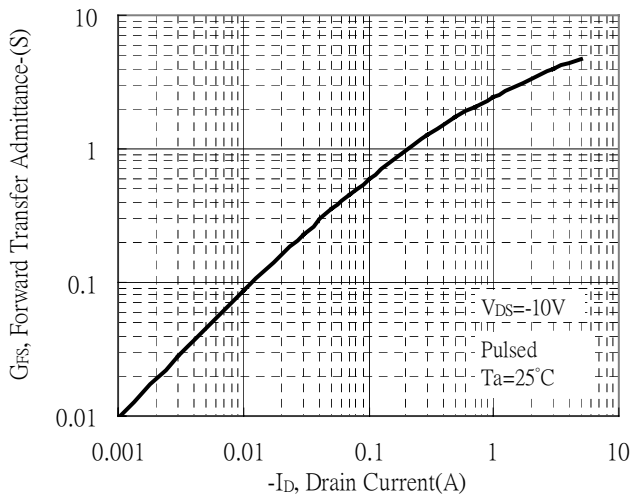

Gate Charge Characteristics

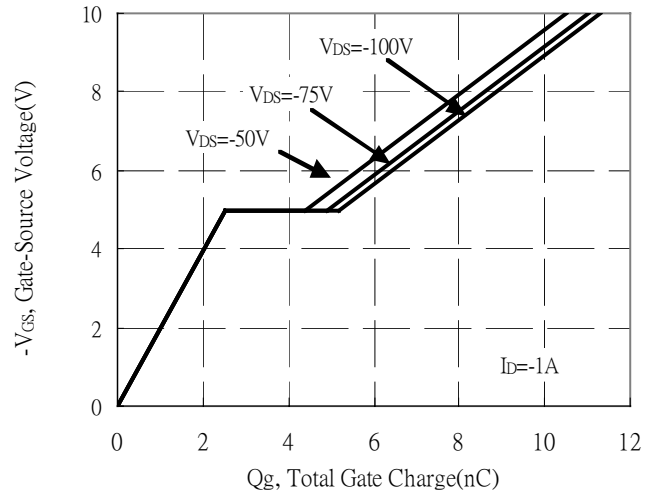

Maximum Safe Operating Area

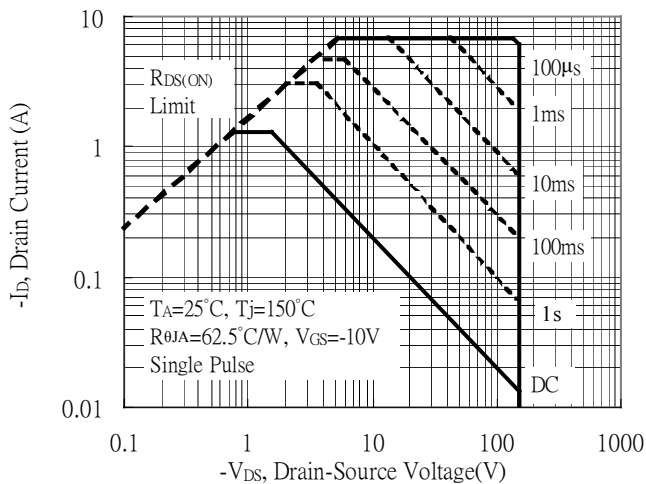

Maximum Drain Current vs Case Temperature

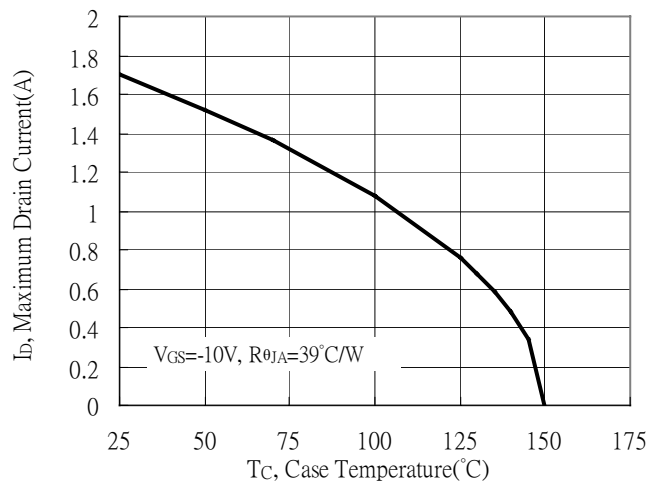

**Typical Characteristics(Cont.)**

Typical Transfer Characteristics

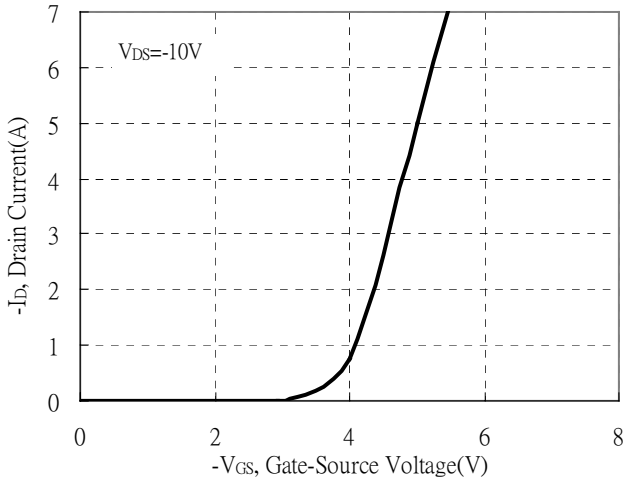

Single Pulse Maximum Power Dissipation

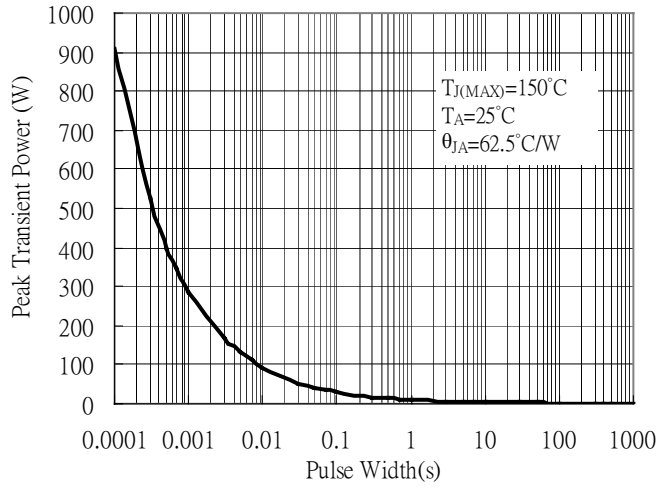

Power Derating Curve

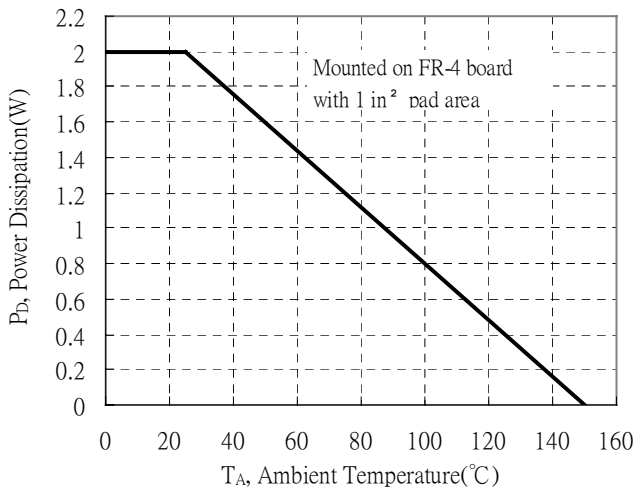

Power Derating Curve

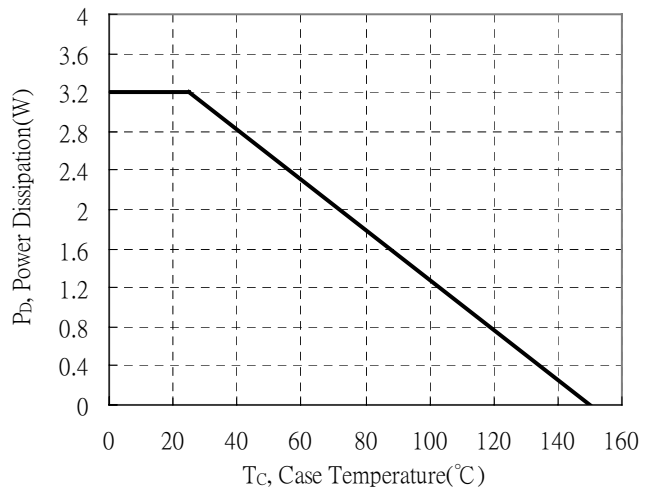

Transient Thermal Response Curves

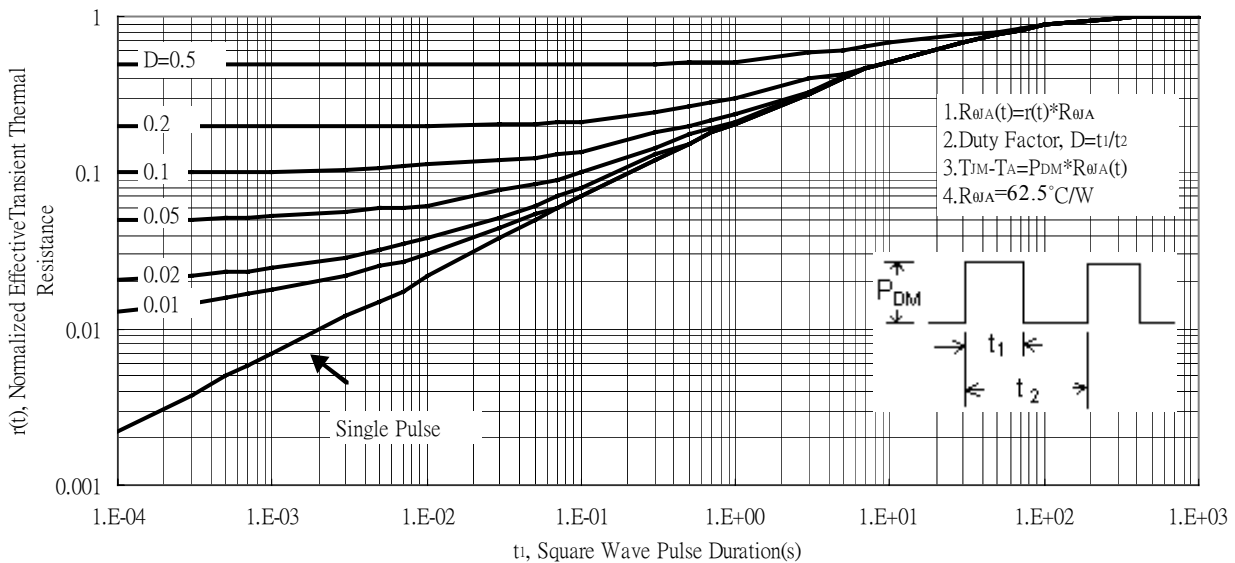

## Recommended Soldering Footprint

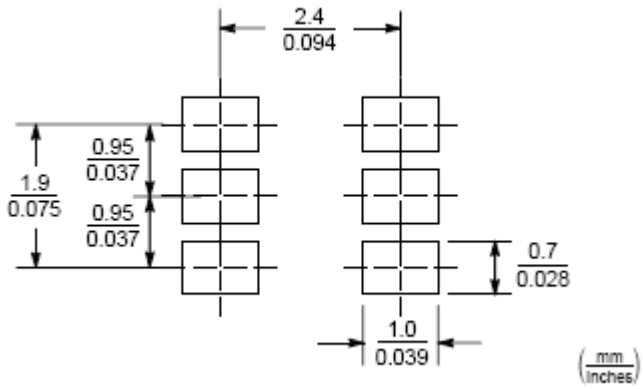

**Reel Dimension**

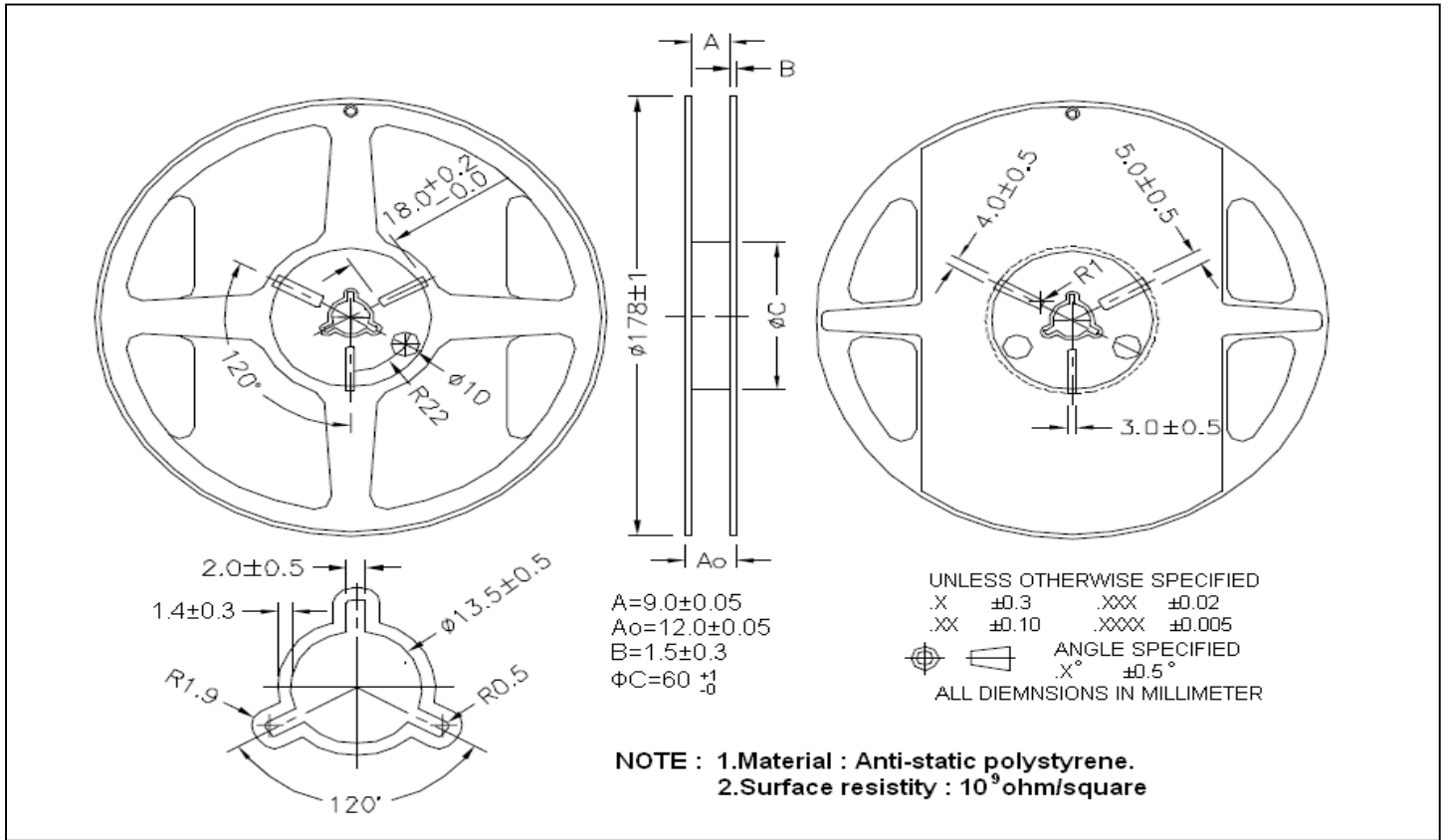

**Carrier Tape Dimension**

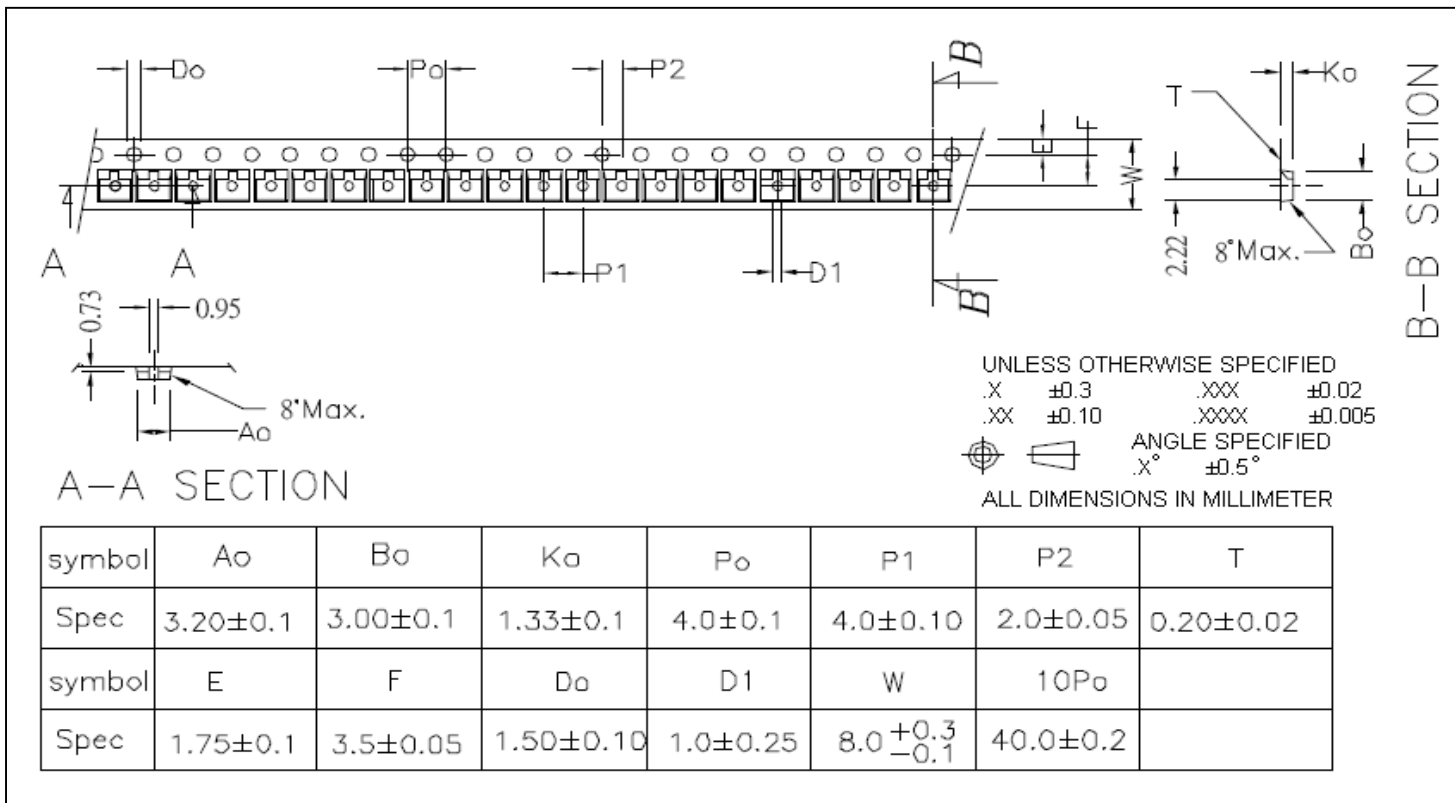

**Recommended wave soldering condition**

Product	Peak Temperature	Soldering Time
Pb-free devices	260 +0/-5 °C	5 +1/-1 seconds

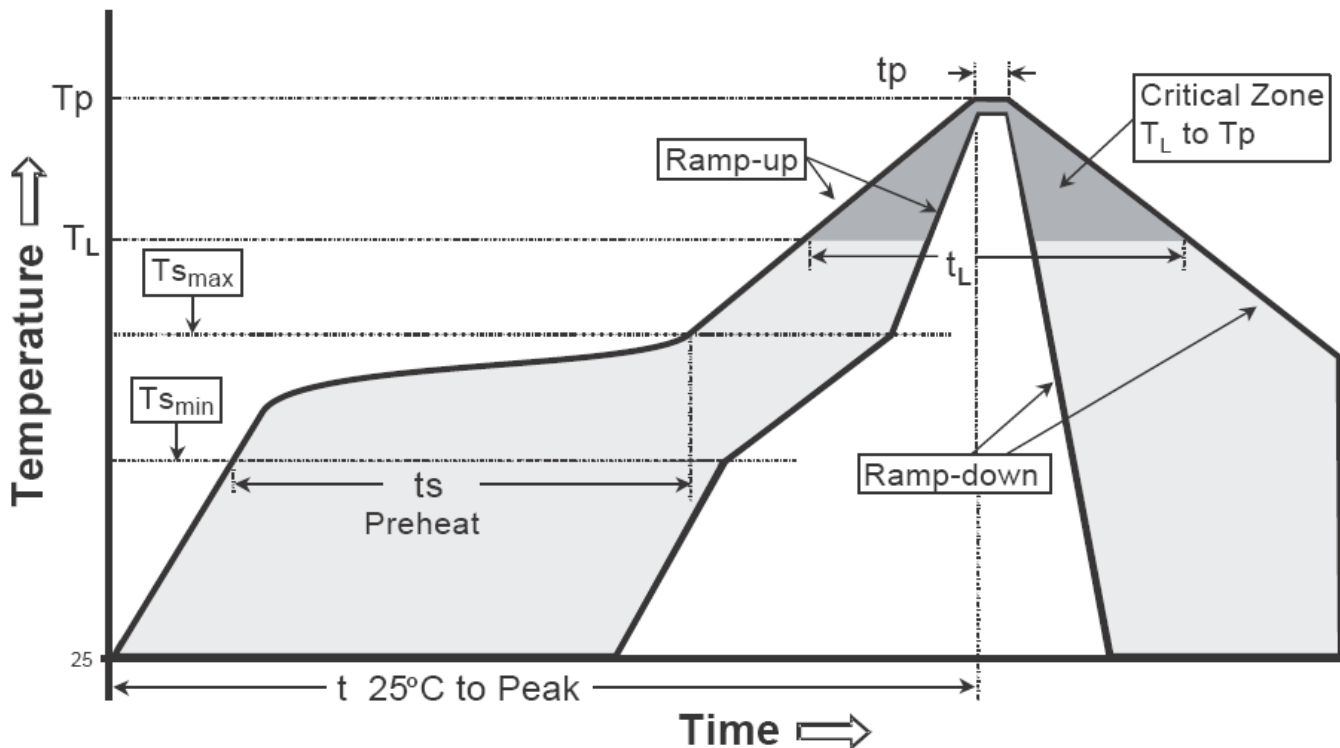
**Recommended temperature profile for IR reflow**

Profile feature	Sn-Pb eutectic Assembly	Pb-free Assembly
Average ramp-up rate (Ts max to Tp)	3°C/second max.	3°C/second max.
Preheat		
-Temperature Min(Ts min)	100°C	150°C
-Temperature Max(Ts max)	150°C	200°C
-Time(ts min to ts max)	60-120 seconds	60-180 seconds
Time maintained above:		
-Temperature (T <sub>L</sub> )	183°C	217°C
- Time (t <sub>L</sub> )	60-150 seconds	60-150 seconds
Peak Temperature(T <sub>P</sub> )	240 +0/-5 °C	260 +0/-5 °C
Time within 5°C of actual peak temperature(tp)	10-30 seconds	20-40 seconds
Ramp down rate	6°C/second max.	6°C/second max.
Time 25 °C to peak temperature	6 minutes max.	8 minutes max.

Note : All temperatures refer to topside of the package, measured on the package body surface.



**SOT-26 Dimension**

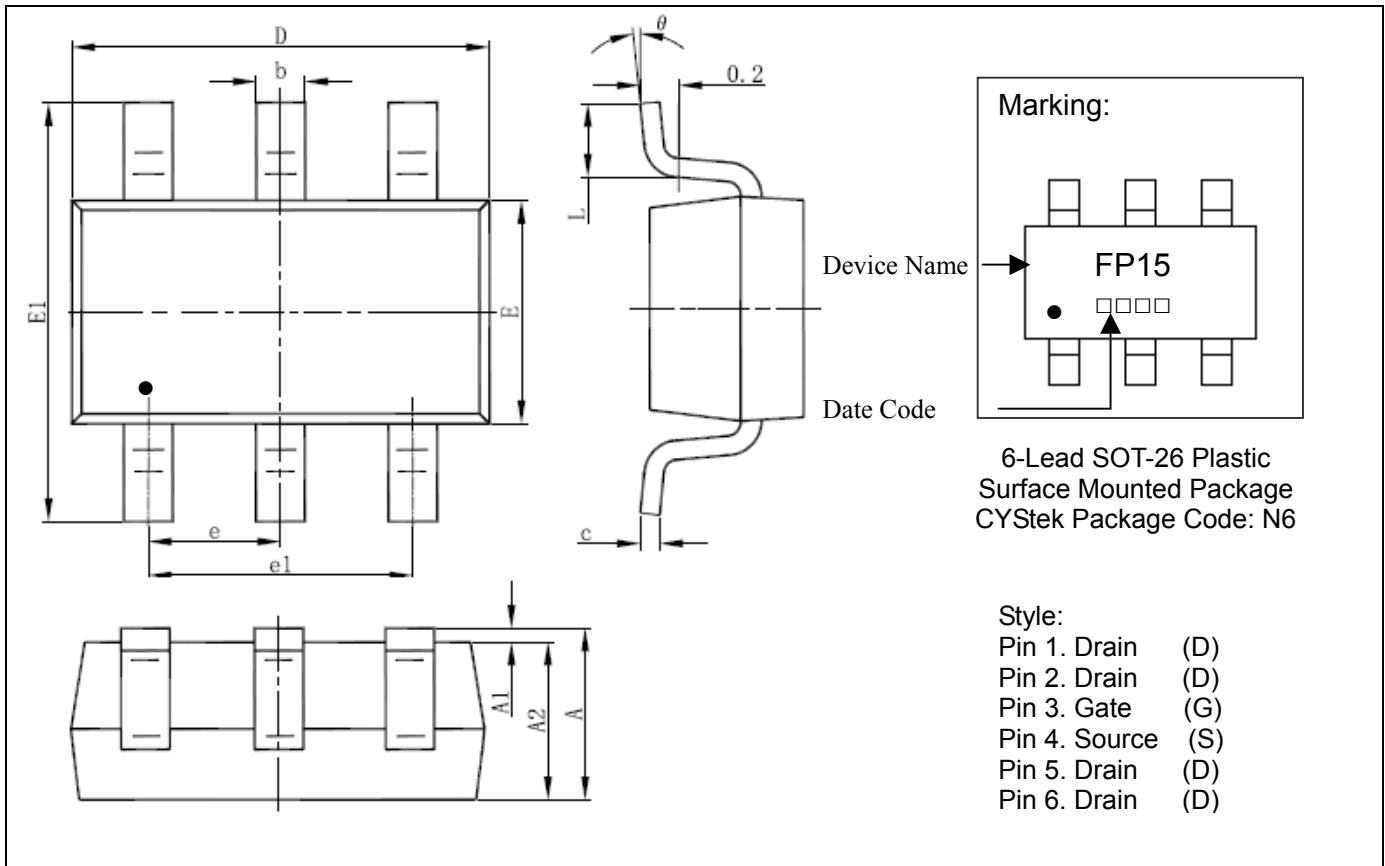

DIM	Millimeters		Inches		DIM	Millimeters		Inches	
	Min.	Max.	Min.	Max.		Min.	Max.	Min.	Max.
A	1.050	1.250	0.041	0.049	E	1.500	1.700	0.059	0.067
A1	0.000	0.100	0.000	0.004	E1	2.650	2.950	0.104	0.116
A2	1.050	1.150	0.041	0.045	e	0.950 (BSC)		0.037 (BSC)	
b	0.300	0.500	0.012	0.020	e1	1.800	2.000	0.071	0.079
c	0.100	0.200	0.004	0.008	L	0.300	0.600	0.012	0.024
D	2.820	3.020	0.111	0.119	θ	0°	8°	0°	8°

**Notes :** 1.Controlling dimension : millimeters.  
 2.Maximum lead thickness includes lead finish thickness, and minimum lead thickness is the minimum thickness of base material.  
 3.If there is any question with packing specification or packing method, please contact your local CYStek sales office.

**Material :**

- Lead : Pure tin plated.
- Mold Compound : Epoxy resin family, flammability solid burning class:UL94V-0.

**Important Notice:**

- All rights are reserved. Reproduction in whole or in part is prohibited without the prior written approval of CYStek.
- CYStek reserves the right to make changes to its products without notice.
- CYStek **semiconductor products are not warranted to be suitable for use in Life-Support Applications, or systems.**
- CYStek assumes no liability for any consequence of customer product design, infringement of patents, or application assistance.