

N -Channel Enhancement Mode Power MOSFET

MTE65N20F3

| | | |
|-------------------------------------|-----------------------|--------------|
| BV_{DSS} | 200V | |
| $I_D @ T_C=25^{\circ}C, V_{GS}=10V$ | 33A | |
| $R_{DS(on)(TYP)}$ | $V_{GS}=10V, I_D=11A$ | 61m Ω |
| | $V_{GS}=6V, I_D=5A$ | 66m Ω |

Features

- Low Gate Charge
- Simple Drive Requirement
- Pb-free lead plating package

Equivalent Circuit

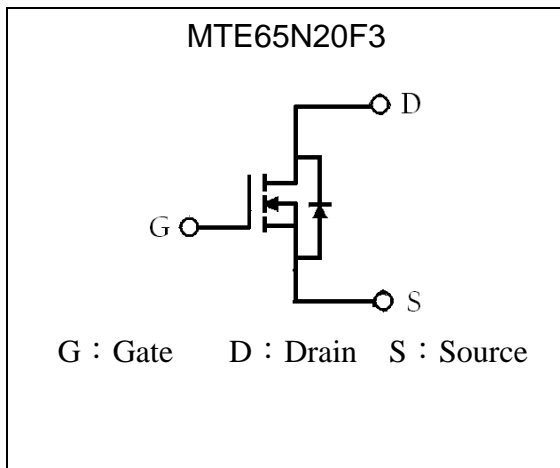

Outline

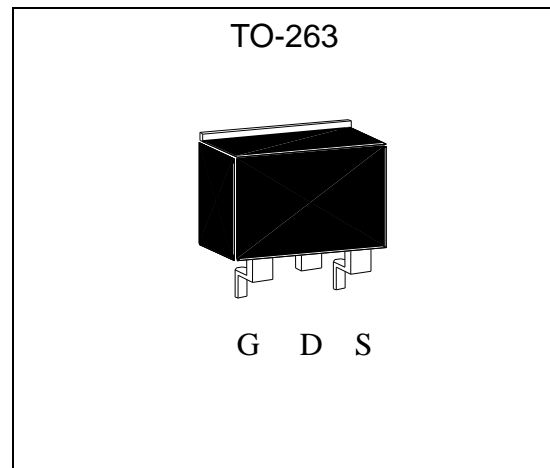

Ordering Information

| Device | Package | Shipping |
|-------------------|---|-----------------------|
| MTE65N20F3-0-T7-X | TO-263 (Pb-free lead plating and RoHS compliant package) | 800 pcs / Tape & Reel |

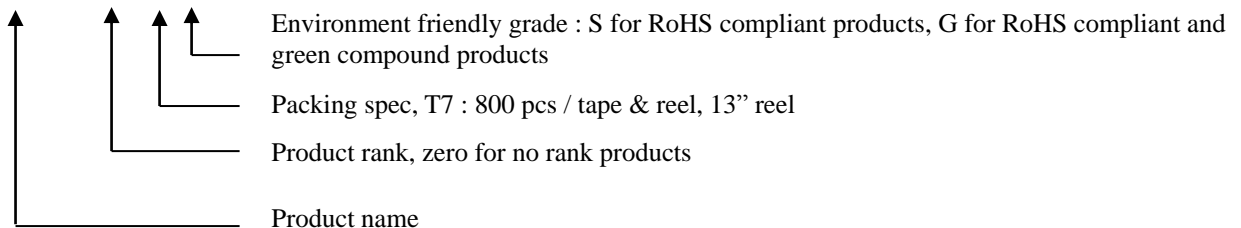



Absolute Maximum Ratings (T_c=25°C, unless otherwise noted)

| Parameter | Symbol | Limits | Unit |
|--|-----------------------------------|----------|------|
| Drain-Source Voltage | V _{DS} | 200 | V |
| Gate-Source Voltage | V _{GS} | ±20 | |
| Continuous Drain Current @ T _c =25°C, V _{GS} =10V | I _D | 33 | A |
| Continuous Drain Current @ T _c =100°C, V _{GS} =10V | I _D | 23 | |
| Pulsed Drain Current *1 | I _{DM} | 70 | |
| Avalanche Current | I _{AS} | 20 | |
| Avalanche Energy @ L=1.6mH, I _D =20A, R _G =25 Ω | E _{AS} | 320 | mJ |
| Repetitive Avalanche Energy @ L=0.1mH (Note 2) | E _{AR} | 4.6 | |
| Total Power Dissipation @ T _c =25°C | P _d | 168 | W |
| Total Power Dissipation @ T _A =25°C | | 3.75 | |
| Operating Junction and Storage Temperature Range | T _j , T _{stg} | -55~+175 | °C |

Note : *1. Pulse width limited by maximum junction temperature
 *2. Duty cycle ≤ 1%

Thermal Data

| Parameter | Symbol | Value | Unit |
|---|---------------------|-------|------|
| Thermal Resistance, Junction-to-case, max | R _{th,j-c} | 0.89 | °C/W |
| Thermal Resistance, Junction-to-ambient, max* | R _{th,j-a} | 40 | |
| Thermal Resistance, Junction-to-ambient, max | | 62.5 | |

*When mounted on the minimum pad size (PCB mount).

Characteristics (T_c=25°C, unless otherwise specified)

| Symbol | Min. | Typ. | Max. | Unit | Test Conditions |
|---------------------------|------|------|------|------|---|
| Static | | | | | |
| BV _{DSS} | 200 | - | - | V | V _{GS} =0V, I _D =250μA |
| V _{GS(th)} | 2 | - | 4 | | V _{DS} = V _{GS} , I _D =250μA |
| I _{GSS} | - | - | ±100 | nA | V _{GS} =±20V, V _{DS} =0V |
| I _{DSS} | - | - | 1 | μA | V _{DS} =180V, V _{GS} =0V |
| | - | - | 25 | | V _{DS} =180V, V _{GS} =0V, T _J =125°C |
| R _{DS(ON)} *1 | - | 61 | 80 | mΩ | V _{GS} =10V, I _D =11A |
| | - | 66 | 100 | | V _{GS} =6V, I _D =5A |
| G _{FS} *1 | - | 15 | - | S | V _{DS} =15V, I _D =11A |
| Dynamic | | | | | |
| Q _g *1, 2 | - | 60 | - | nC | V _{DS} =160V, I _D =25A, V _{GS} =10V |
| Q _{gs} *1, 2 | - | 12.1 | - | | |
| Q _{gd} *1, 2 | - | 24.2 | - | | |
| t _{d(ON)} *1, 2 | - | 62 | - | ns | V _{DS} =100V, I _D =20A, V _{GS} =10V, R _G =25 Ω |
| t _r *1, 2 | - | 62 | - | | |
| t _{d(OFF)} *1, 2 | - | 200 | - | | |
| t _f *1, 2 | - | 100 | - | | |
| C _{iss} | - | 2447 | - | pF | V _{GS} =0V, V _{DS} =25V, f=1MHz |
| C _{oss} | - | 180 | - | | |
| C _{rss} | - | 102 | - | | |



| Source-Drain Diode | | | | | |
|--------------------|---|------|-----|----|--|
| I _S *1 | - | - | 20 | A | |
| I _{SM} *3 | - | - | 40 | | |
| V _{SD} *1 | - | 0.82 | 1.3 | V | I _F =I _S , V _{GS} =0V |
| trr | - | 120 | - | ns | I _F =20A, dI _F /dt=100A/μs |
| Q _{rr} | - | 400 | - | nC | |

Note : *1.Pulse Test : Pulse Width ≤300μs, Duty Cycle≤2%
*2.Independent of operating temperature
*3.Pulse width limited by maximum junction temperature.

Typical Characteristics

Typical Output Characteristics

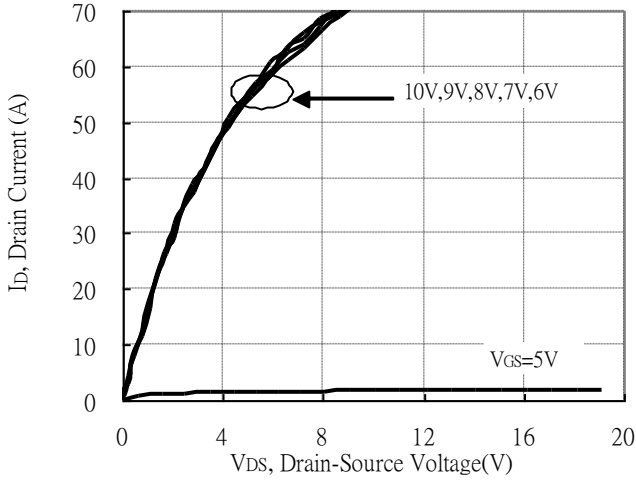

Brekdown Voltage vs Ambient Temperature

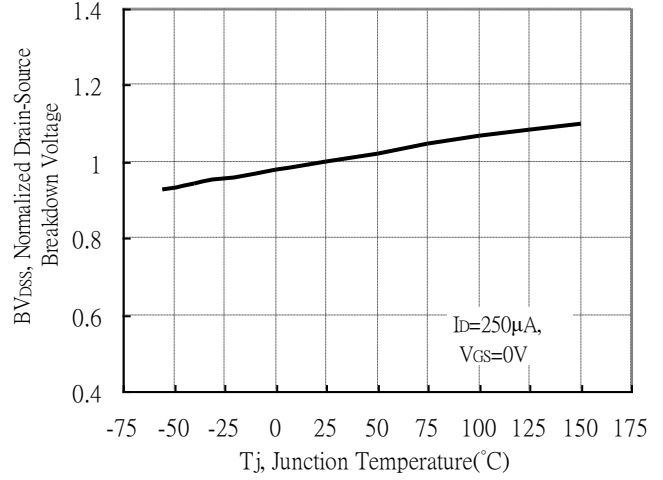

Static Drain-Source On-State resistance vs Drain Current

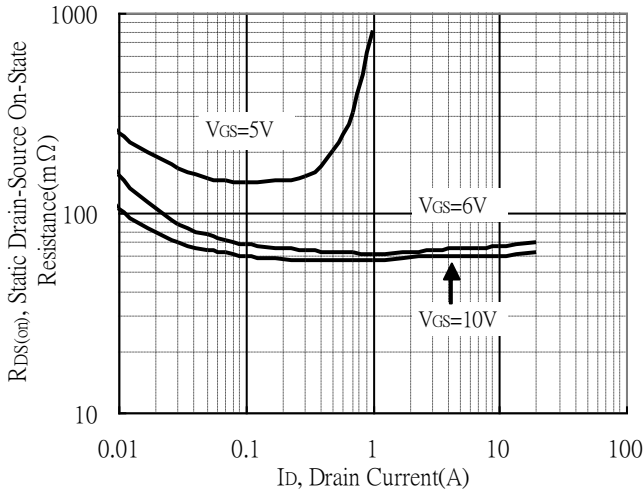

Reverse Drain Current vs Source-Drain Voltage

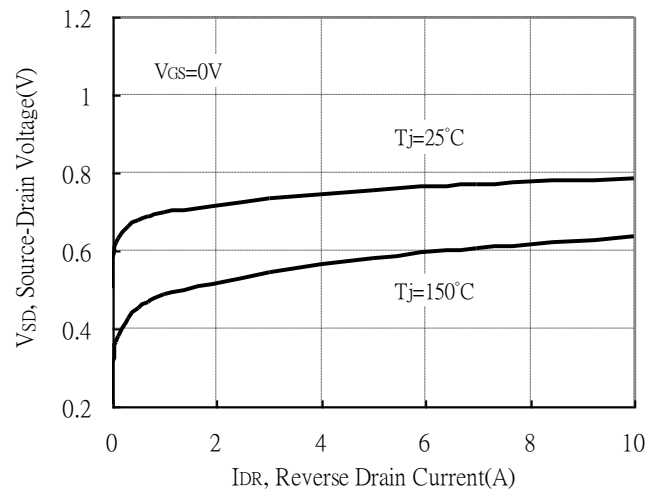

Static Drain-Source On-State Resistance vs Gate-Source Voltage

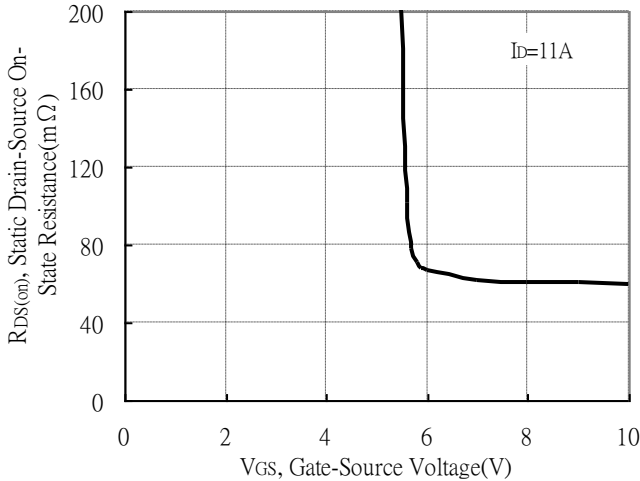

Drain-Source On-State Resistance vs Junction Temperature

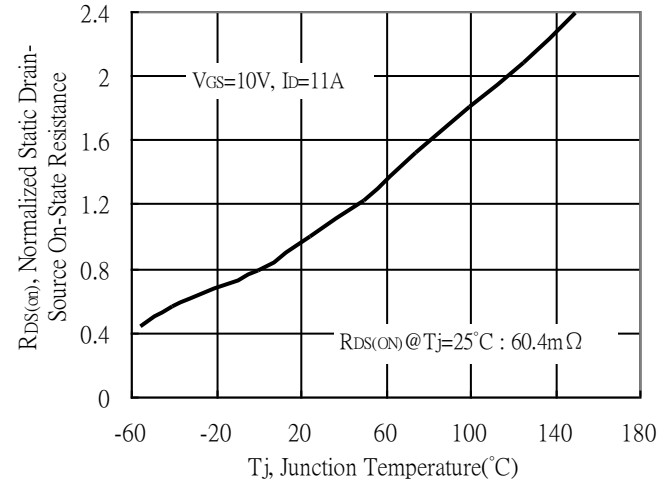

Typical Characteristics(Cont.)

Capacitance vs Drain-to-Source Voltage

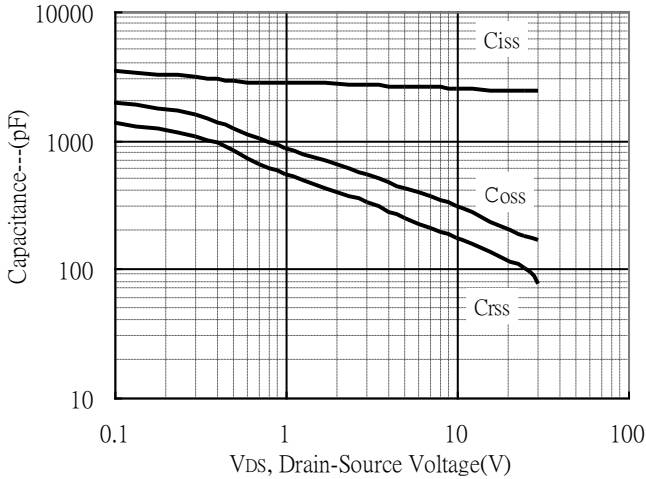

Threshold Voltage vs Junction Temperature

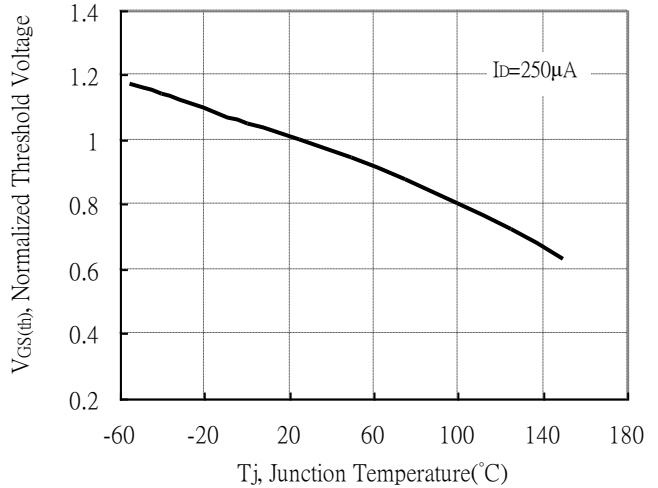

Forward Transfer Admittance vs Drain Current

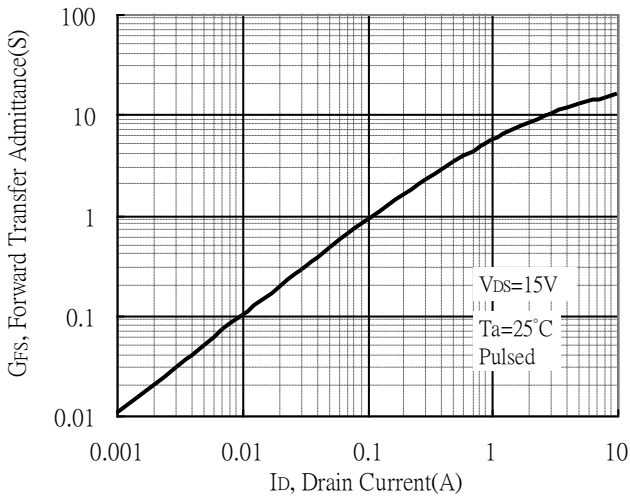

Gate Charge Characteristics

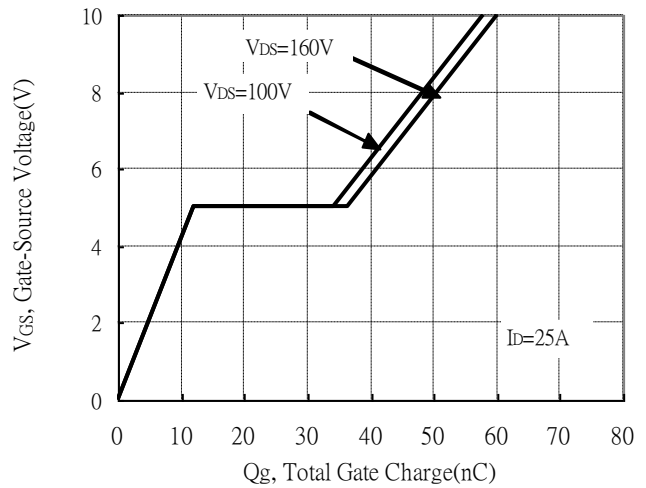

Maximum Safe Operating Area

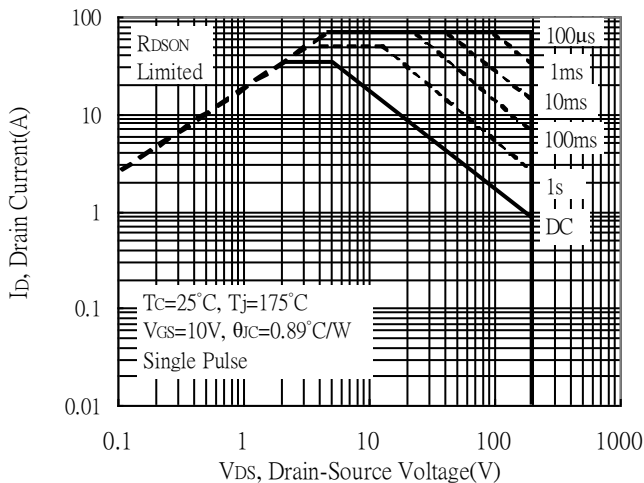

Maximum Drain Current vs Case Temperature

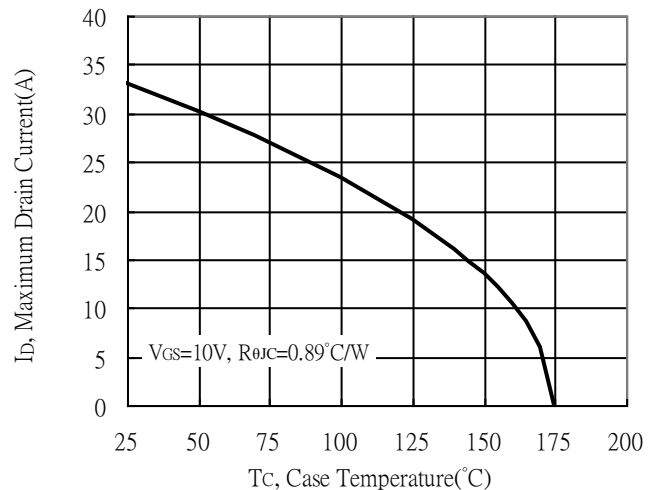



Typical Characteristics(Cont.)

Typical Transfer Characteristics

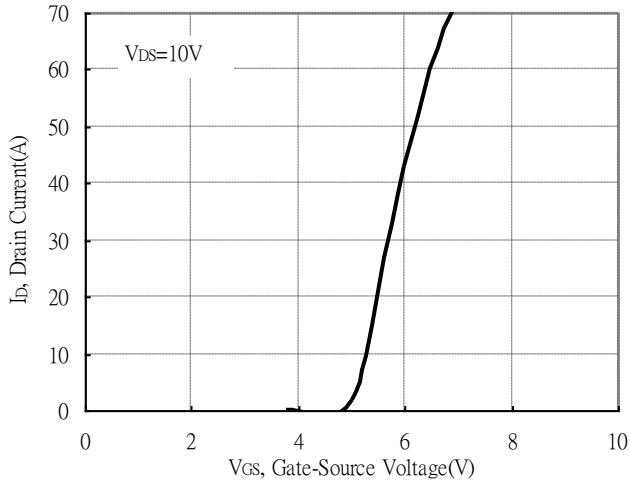

Power Derating Curve

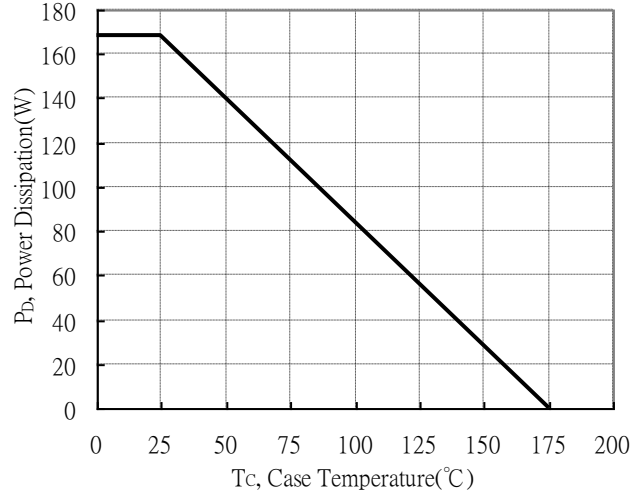

Transient Thermal Response Curves

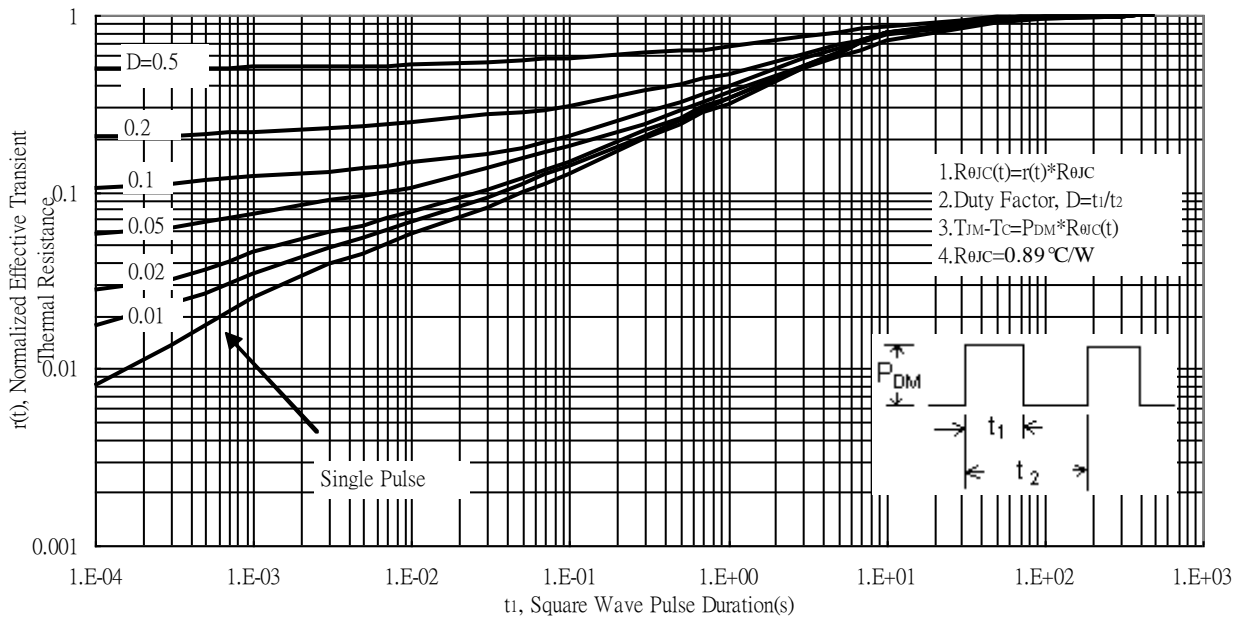

Reel Dimension

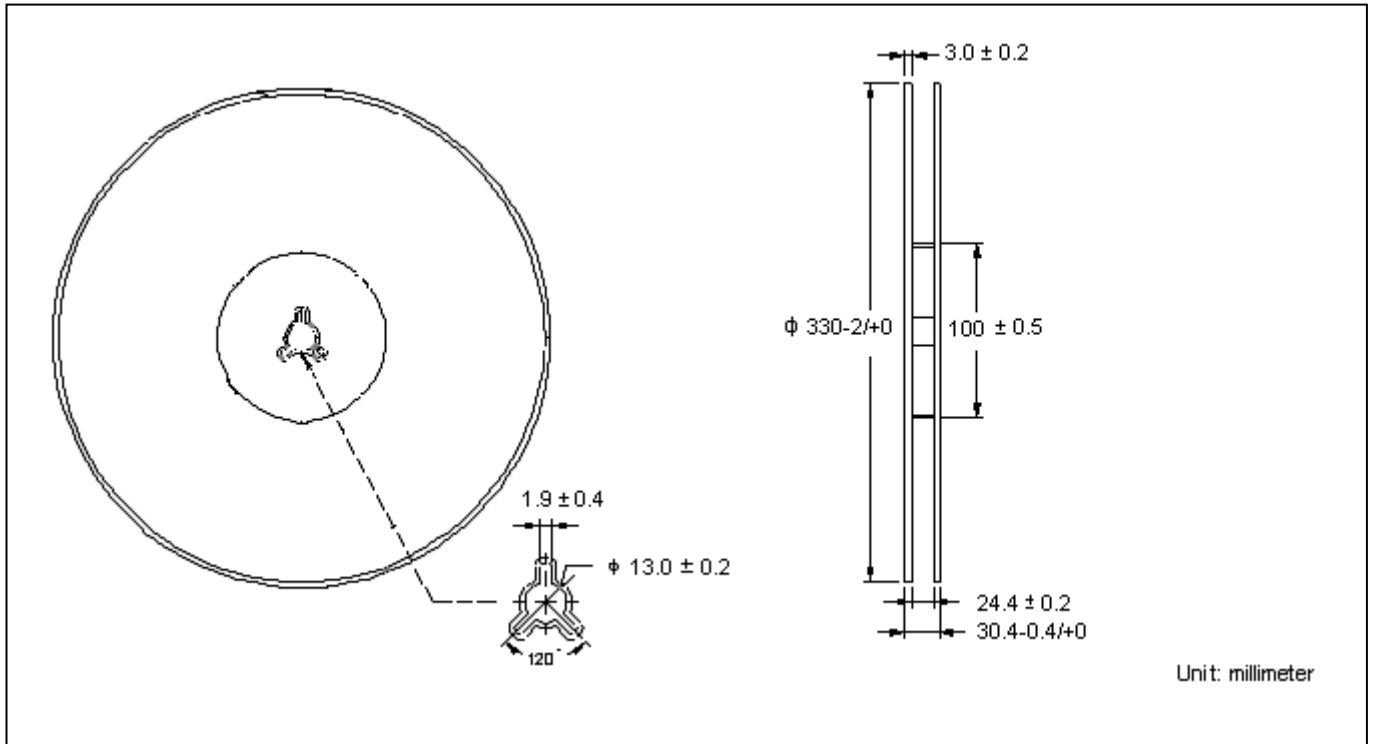

Carrier Tape Dimension

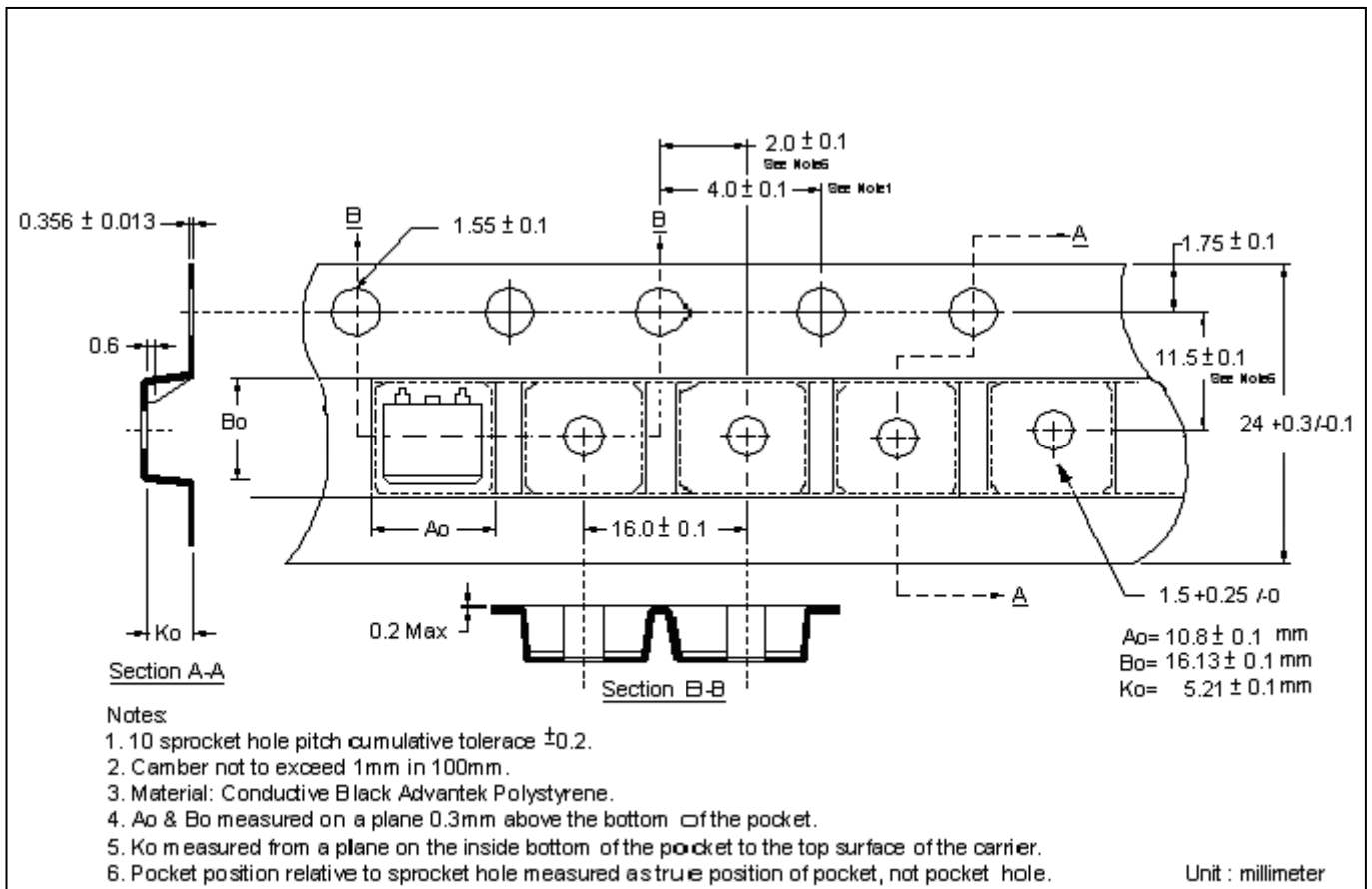

Recommended wave soldering condition

| | | |
|-----------------|------------------|-----------------|
| Product | Peak Temperature | Soldering Time |
| Pb-free devices | 260 +0/-5 °C | 5 +1/-1 seconds |

Recommended temperature profile for IR reflow

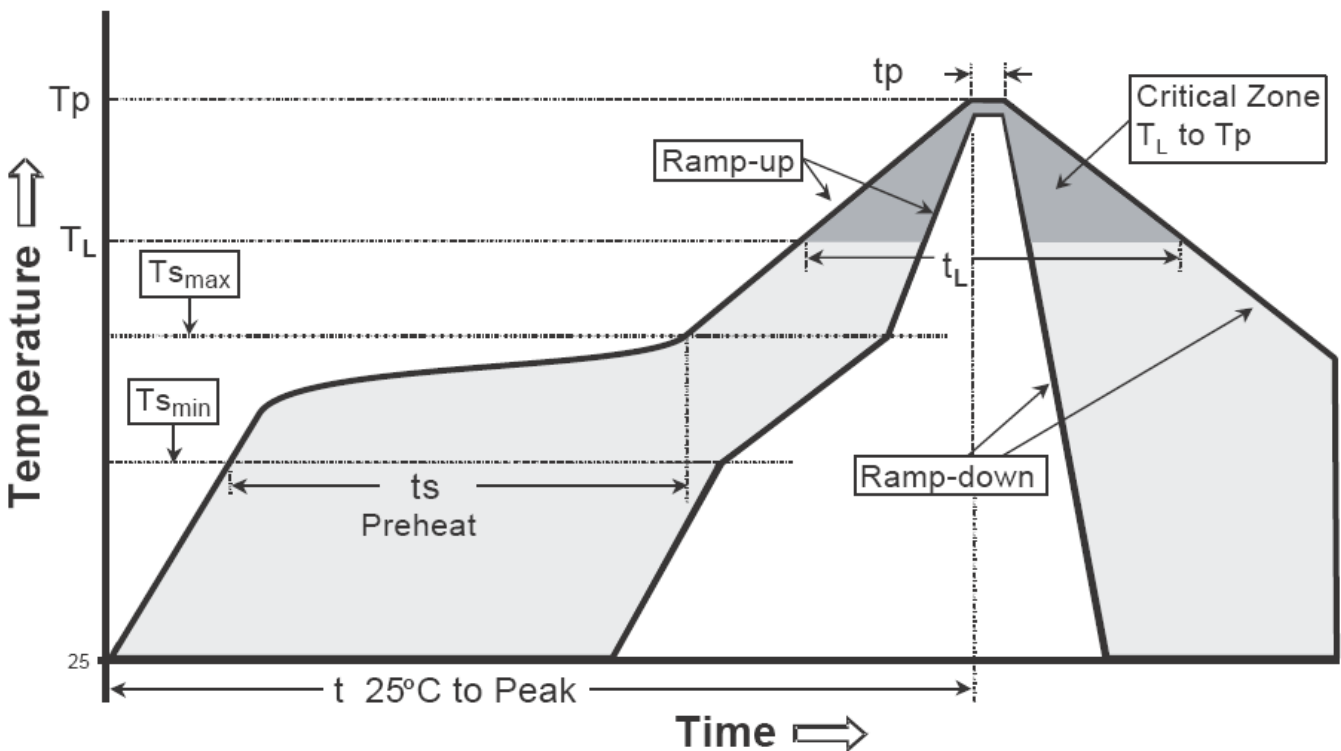

| Profile feature | Sn-Pb eutectic Assembly | Pb-free Assembly |
|--|-------------------------|------------------|
| Average ramp-up rate (Tsmax to Tp) | 3°C/second max. | 3°C/second max. |
| Preheat | | |
| -Temperature Min(Ts min) | 100°C | 150°C |
| -Temperature Max(Ts max) | 150°C | 200°C |
| -Time(ts min to ts max) | 60-120 seconds | 60-180 seconds |
| Time maintained above: | | |
| -Temperature (TL) | 183°C | 217°C |
| - Time (tL) | 60-150 seconds | 60-150 seconds |
| Peak Temperature(TP) | 240 +0/-5 °C | 260 +0/-5 °C |
| Time within 5°C of actual peak temperature(tp) | 10-30 seconds | 20-40 seconds |
| Ramp down rate | 6°C/second max. | 6°C/second max. |
| Time 25 °C to peak temperature | 6 minutes max. | 8 minutes max. |

Note : All temperatures refer to topside of the package, measured on the package body surface.

TO-263 Dimension

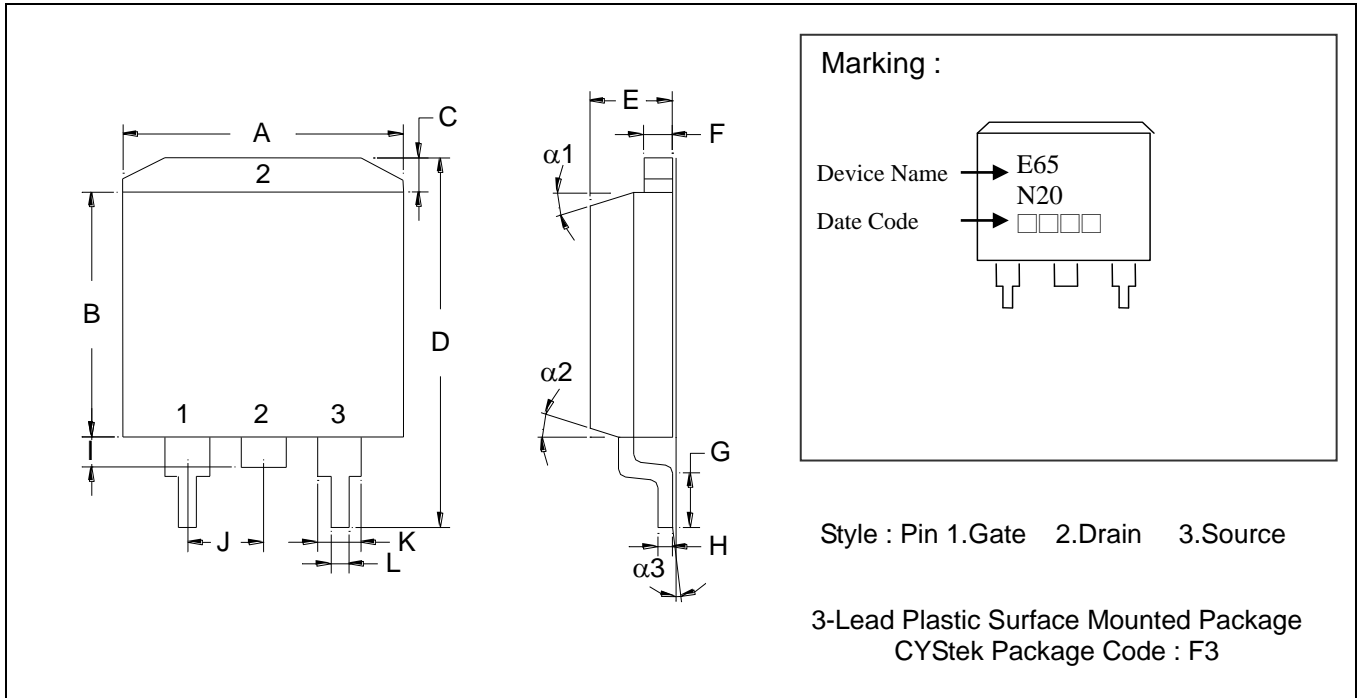

*:Typical

| DIM | Inches | | Millimeters | | DIM | Inches | | Millimeters | |
|-----|--------|--------|-------------|-------|------------|--------|---------|-------------|-------|
| | Min. | Max. | Min. | Max. | | Min. | Max. | Min. | Max. |
| A | 0.3800 | 0.4050 | 9.65 | 10.29 | I | 0.0500 | 0.0700 | 1.27 | 1.78 |
| B | 0.3300 | 0.3700 | 8.38 | 9.40 | J | - | *0.1000 | - | *2.54 |
| C | - | 0.0550 | - | 1.40 | K | 0.0450 | 0.0550 | 1.14 | 1.40 |
| D | 0.5750 | 0.6250 | 14.61 | 15.88 | L | 0.0200 | 0.0390 | 0.51 | 0.99 |
| E | 0.1600 | 0.1900 | 4.06 | 4.83 | $\alpha 1$ | - | - | 6° | 8° |
| F | 0.0450 | 0.0550 | 1.14 | 1.40 | $\alpha 2$ | - | - | 6° | 8° |
| G | 0.0900 | 0.1100 | 2.29 | 2.79 | $\alpha 3$ | - | - | 0° | 5° |
| H | 0.0180 | 0.0290 | 0.46 | 0.74 | | | | | |

Notes : 1.Controlling dimension : millimeters.
 2.Maximum lead thickness includes lead finish thickness, and minimum lead thickness is the minimum thickness of base material.
 3.If there is any question with packing specification or packing method, please contact your local CYStek sales office.

Material :

- Lead : Pure tin plated.
- Mold Compound : Epoxy resin family, flammability solid burning class:UL94V-0.

Important Notice:

- All rights are reserved. Reproduction in whole or in part is prohibited without the prior written approval of CYStek.
- CYStek reserves the right to make changes to its products without notice.
- CYStek **semiconductor products are not warranted to be suitable for use in Life-Support Applications, or systems.**
- CYStek assumes no liability for any consequence of customer product design, infringement of patents, or application assistance.