

P-Channel Enhancement Mode Power MOSFET

MTE450P20E3

BV _{DSS}	-200V
I _D @ V _{GS} =-10V, T _C =25°C	-9A
I _D @ V _{GS} =-10V, T _A =25°C	-1.4A
R _{DS(on)(TYP)} @ V _{GS} =-10V, I _D =-3.9A	368mΩ

Features

- Low Gate Charge
- Simple Drive Requirement
- Repetitive Avalanche Rated
- Fast Switching Characteristic
- RoHS compliant package

Symbol

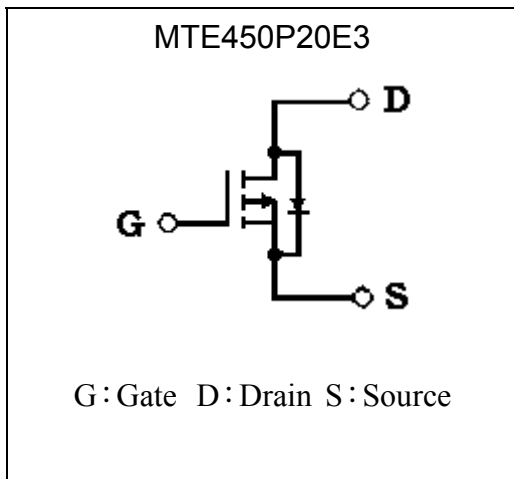

Outline

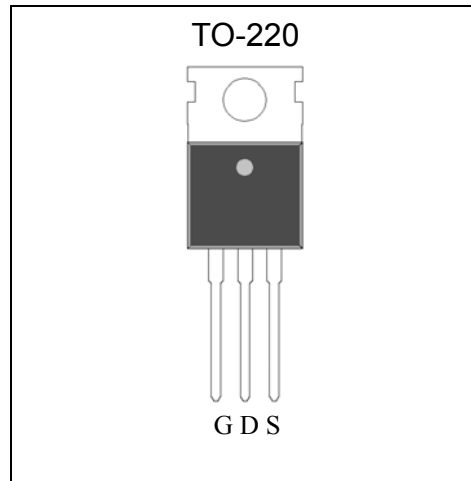

Ordering Information

Device	Package	Shipping
MTE450P20E3-0-UB-X	TO-220 (Pb-free lead plating package)	50 pcs/tube, 20 tubes/box, 4 boxes / carton

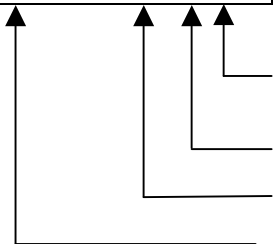

Environment friendly grade : S for RoHS compliant products, G for RoHS compliant and green compound products
 Packing spec, UB : 50 pcs / tube, 20 tubes/box
 Product rank, zero for no rank products
 Product name

**Absolute Maximum Ratings** ($T_C=25^\circ\text{C}$, unless otherwise noted)

Parameter		Symbol	Limits	Unit
Drain-Source Voltage		V_{DS}	-200	V
Gate-Source Voltage		V_{GS}	± 20	
Continuous Drain Current @ $T_C=25^\circ\text{C}$, $V_{GS}=-10\text{V}$	(Note 5)	I_D	-9	A
Continuous Drain Current @ $T_C=100^\circ\text{C}$, $V_{GS}=-10\text{V}$	(Note 5)		-5.7	
Pulsed Drain Current	(Note 3)	I_{DM}	-30	
Continuous Drain Current @ $T_A=25^\circ\text{C}$	(Note 2)	I_{DSM}	-1.4	
Continuous Drain Current @ $T_A=70^\circ\text{C}$	(Note 2)		-1.1	
Avalanche Current @ $L=0.1\text{mH}$	(Note 3)	I_{AS}	-27	
Avalanche Energy @ $L=2\text{mH}$, $I_D=-15\text{A}$, $V_{DS}=-30\text{V}$	(Note 4)	E_{AS}	225	mJ
Power Dissipation	$T_C=25^\circ\text{C}$	P_D	83	W
	$T_C=100^\circ\text{C}$		(Note 1)	
Power Dissipation	$T_A=25^\circ\text{C}$	P_{DSM}	2	
	$T_A=70^\circ\text{C}$		(Note 2)	
Operating Junction and Storage Temperature		T_j, T_{stg}	-55~+150	$^\circ\text{C}$

Thermal Data

Parameter	Symbol	Value	Unit
Thermal Resistance, Junction-to-case, max	$R_{\theta JC}$	1.5	$^\circ\text{C}/\text{W}$
Thermal Resistance, Junction-to-ambient, max, $t \leq 10\text{s}$	$R_{\theta JA}$	15	
Thermal Resistance, Junction-to-ambient, max		(Note 1)	

- Note :
- The power dissipation P_D is based on $T_{J(MAX)}=150^\circ\text{C}$, using junction-to-case thermal resistance, and is more useful in setting the upper dissipation limit for cases where additional heatsinking is used.
 - The value of $R_{\theta JA}$ is measured with the device mounted on 1 in² FR-4 board with 2 oz. copper, in a still air environment with $T_A=25^\circ\text{C}$. The power dissipation P_{DSM} is based on $R_{\theta JA}$ and the maximum allowed junction temperature of 150°C . The value in any given application depends on the user's specific board design.
 - Pulse width limited by junction temperature $T_{J(MAX)}=150^\circ\text{C}$. Ratings are based on low frequency and low duty cycles to keep initial $T_J=25^\circ\text{C}$.
 - 100% tested by conditions of $L=2\text{mH}$, $I_{AS}=-6\text{A}$, $V_{GS}=-10\text{V}$, $V_{DD}=-50\text{V}$
 - Calculated continuous drain current based on maximum allowable junction temperature.
 - The static characteristics are obtained using $<300\mu\text{s}$ pulses, duty cycle 0.5% maximum.
 - The $R_{\theta JA}$ is the sum of thermal resistance from junction to case $R_{\theta JC}$ and case to ambient.



Characteristics (Tc=25°C, unless otherwise specified)

Symbol	Min.	Typ.	Max.	Unit	Test Conditions
Static					
BV _{DSS}	-200	-	-	V	V _{GS} =0V, I _D =-250μA
V _{GS(th)}	-2	-	-4		V _{DS} = V _{GS} , I _D =-250μA
G _{FS}	-	9.2	-	S	V _{DS} =-10V, I _D =-5A
I _{GSS}	-	-	±100	nA	V _{GS} =±20V, V _{DS} =0V
I _{DSS}	-	-	-1	μA	V _{DS} =-160V, V _{GS} =0V
	-	-	-10		V _{DS} =-160V, V _{GS} =0V, T _j =125°C
*R _{DS(ON)}	-	368	520	mΩ	V _{GS} =-10V, I _D =-3.9A
Dynamic					
*Q _g	-	29.3	-	nC	I _D =-6.5A, V _{DS} =-160V, V _{GS} =-10V
*Q _{gs}	-	7.1	-		
*Q _{gd}	-	9.9	-		
*t _{d(ON)}	-	18	-	ns	V _{DS} =-100V, I _D =-6.5A, V _{GS} =-10V, R _G =12Ω
*t _r	-	29.6	-		
*t _{d(OFF)}	-	52.4	-		
*t _f	-	81.4	-		
C _{iss}	-	1351	-	pF	V _{GS} =0V, V _{DS} =-25V, f=1MHz
C _{oss}	-	82	-		
C _{rss}	-	37	-		
Source-Drain Diode					
*I _S	-	-	-9	A	
*I _S	-	-	-30		
*V _{SD}	-	-0.92	-1.2	V	I _S =-6.5A, V _{GS} =0V
*t _{rr}	-	75.5	-	ns	I _F =-6.5A, V _{GS} =0V, dI _F /dt=100A/μs
*Q _{rr}	-	236	-	nC	

*Pulse Test : Pulse Width ≤300μs, Duty Cycle≤2%



Typical Characteristics

Typical Output Characteristics

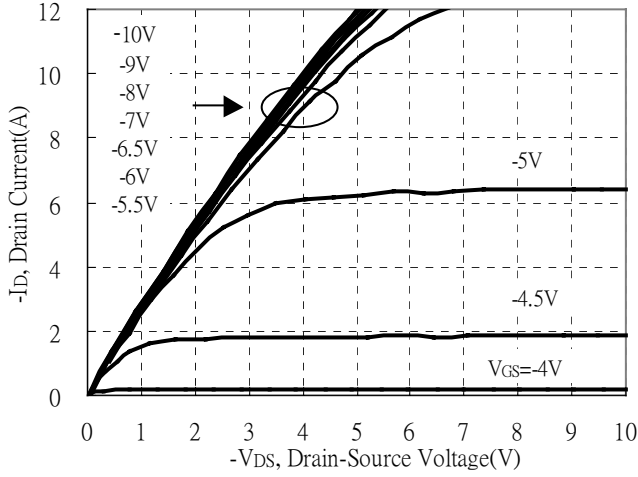

Brekdown Voltage vs Junction Temperature

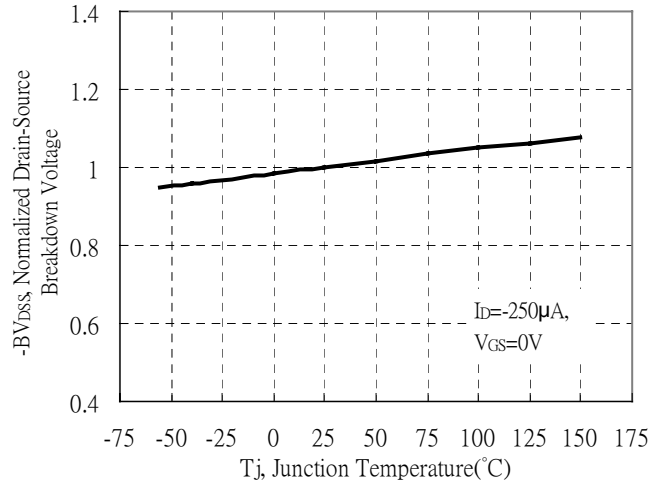

Static Drain-Source On-State resistance vs Drain Current

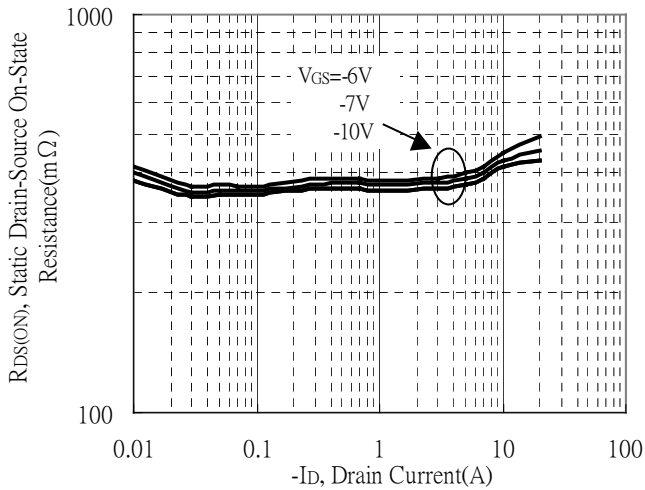

Reverse Drain Current vs Source-Drain Voltage

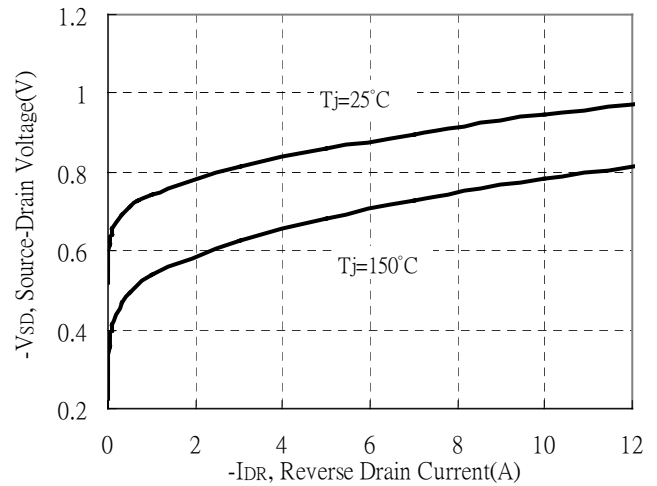

Static Drain-Source On-State Resistance vs Gate-Source Voltage

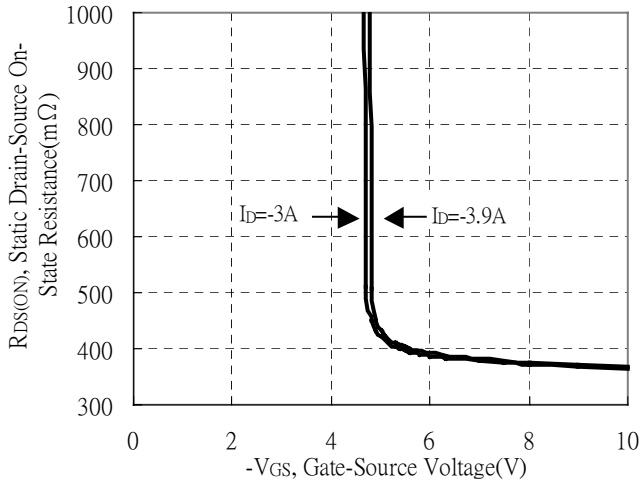

Drain-Source On-State Resistance vs Junction Temperature

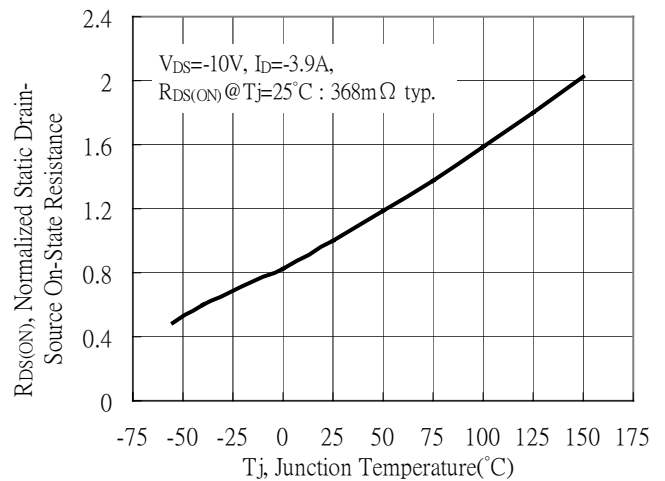

Typical Characteristics(Cont.)

Capacitance vs Drain-to-Source Voltage

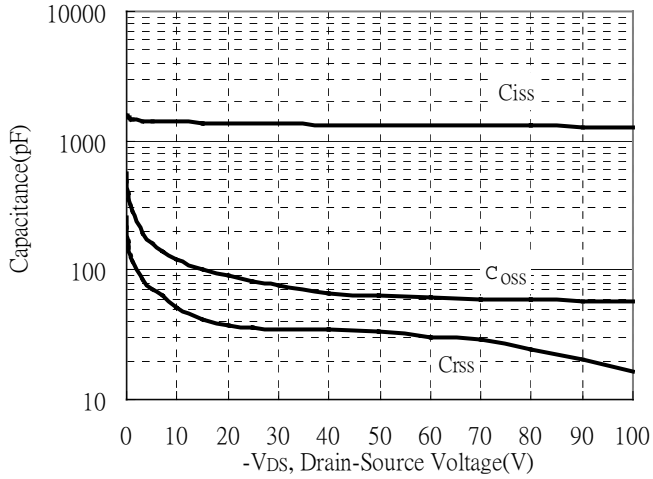

Threshold Voltage vs Junction Temperature

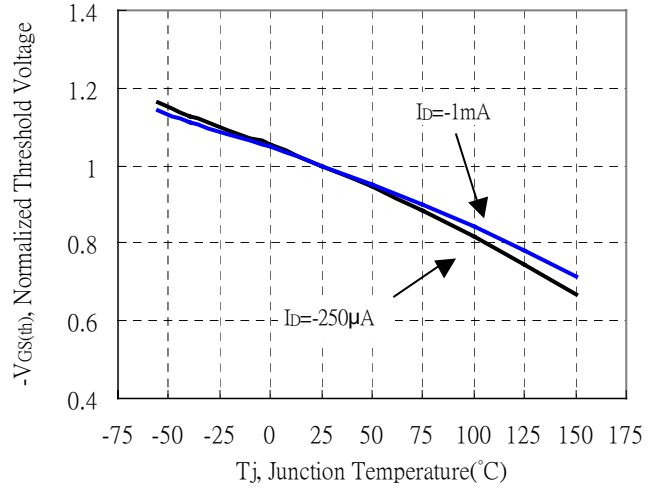

Forward Transfer Admittance vs Drain Current

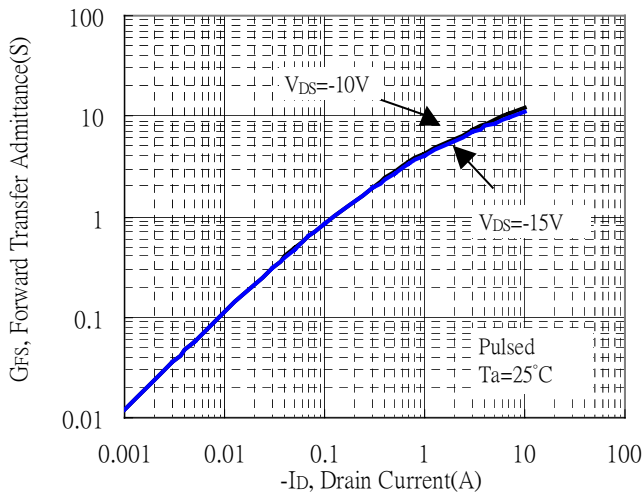

Gate Charge Characteristics

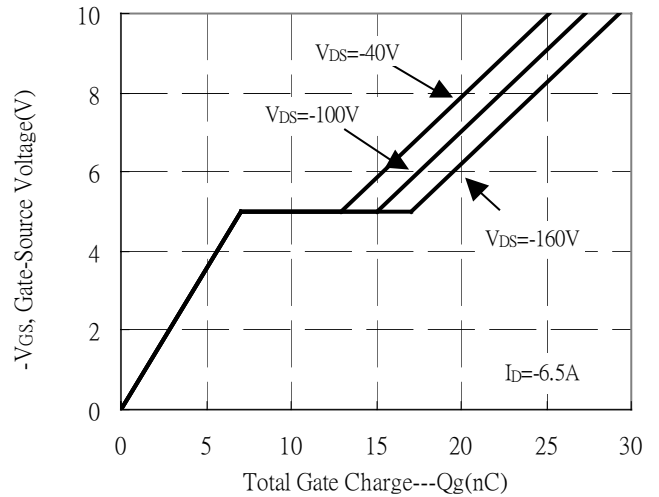

Maximum Safe Operating Area

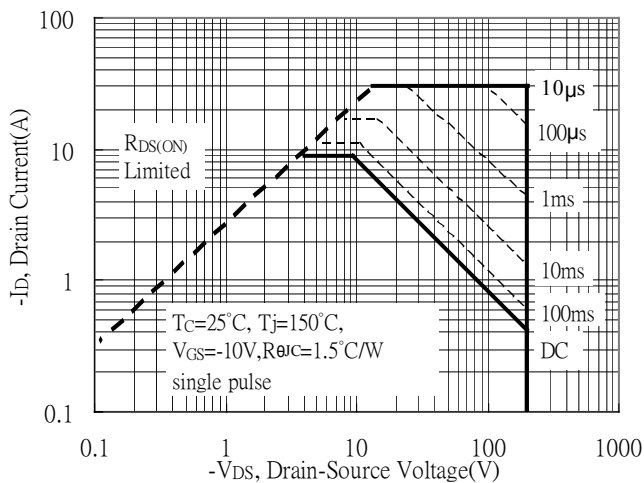

Maximum Drain Current vs Case Temperature

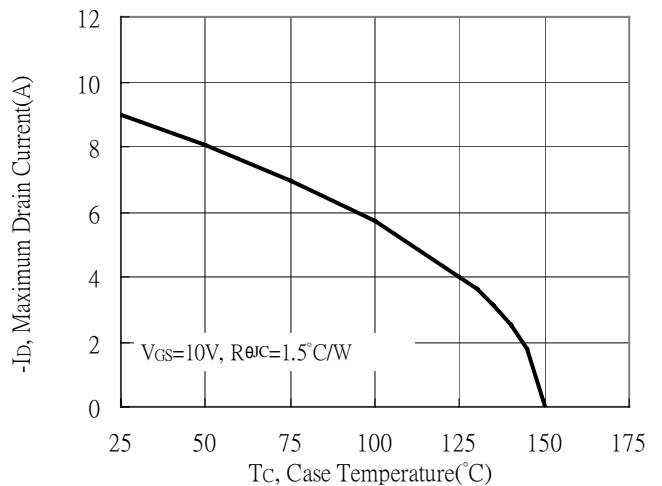



Typical Characteristics(Cont.)

Typical Transfer Characteristics

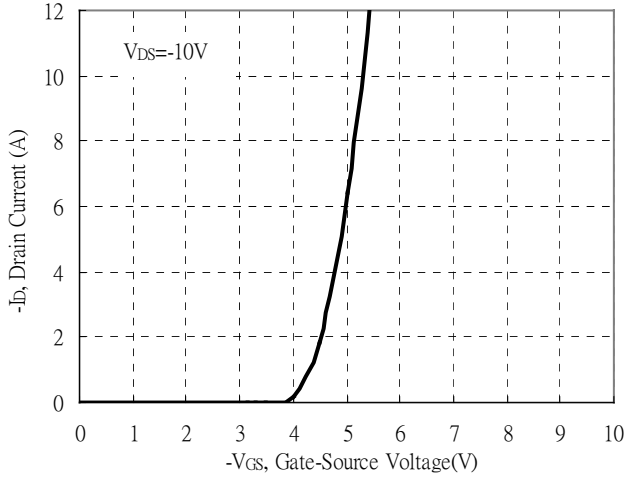

Single Pulse Maximum Power Dissipation

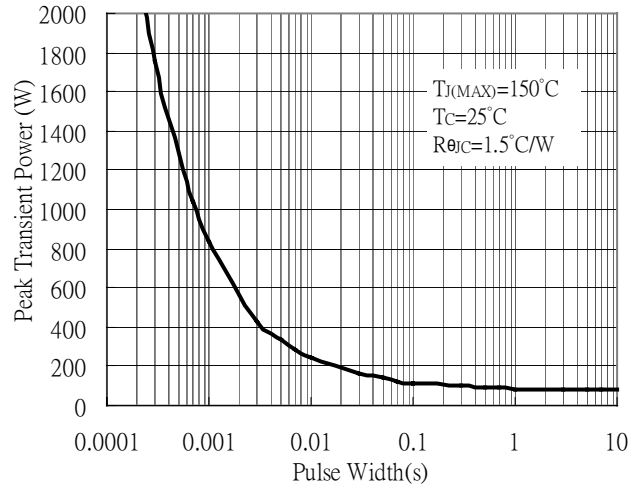

Transient Thermal Response Curves

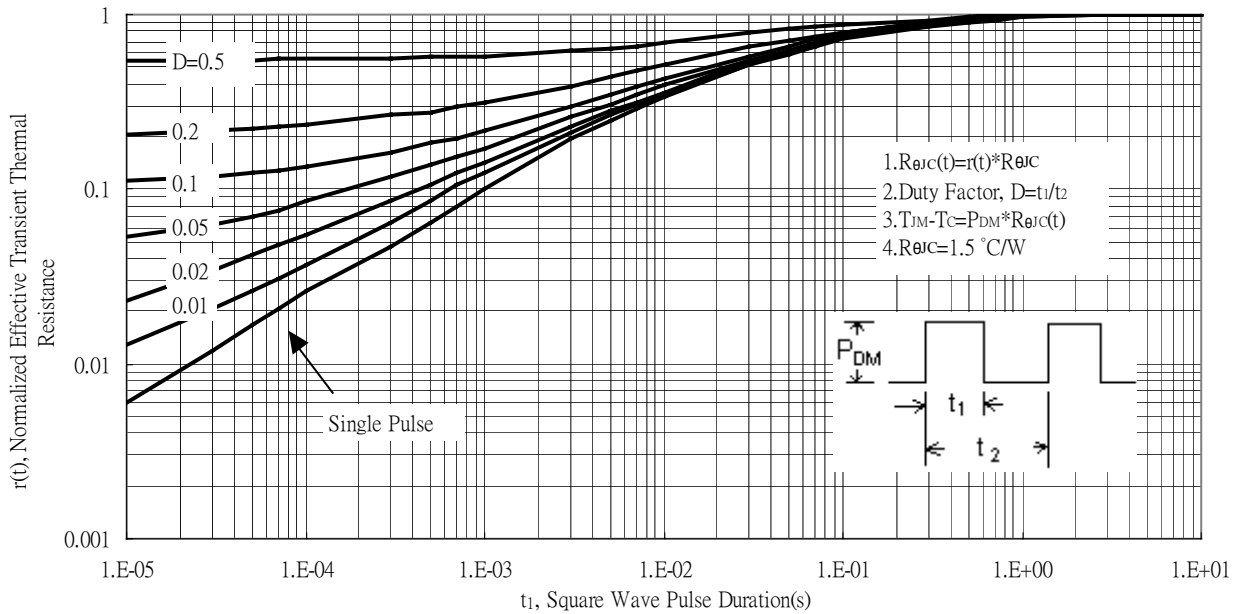

Recommended wave soldering condition

Product	Peak Temperature	Soldering Time
Pb-free devices	260 +0/-5 °C	5 +1/-1 seconds

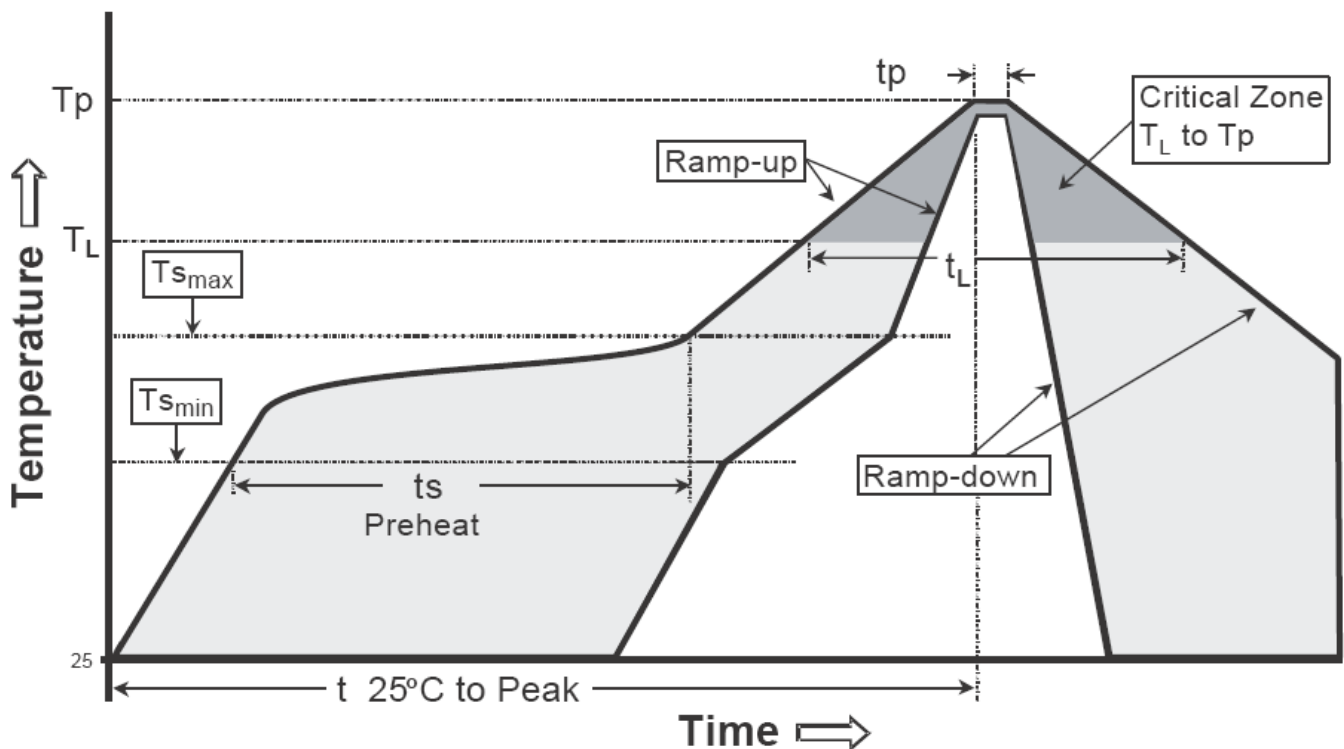
Recommended temperature profile for IR reflow

Profile feature	Sn-Pb eutectic Assembly	Pb-free Assembly
Average ramp-up rate (T _{smax} to T _p)	3°C/second max.	3°C/second max.
Preheat		
-Temperature Min(T _{s min})	100°C	150°C
-Temperature Max(T _{s max})	150°C	200°C
-Time(t _{s min} to t _{s max})	60-120 seconds	60-180 seconds
Time maintained above:		
-Temperature (T _L)	183°C	217°C
- Time (t _L)	60-150 seconds	60-150 seconds
Peak Temperature(T _P)	240 +0/-5 °C	260 +0/-5 °C
Time within 5°C of actual peak temperature(t _p)	10-30 seconds	20-40 seconds
Ramp down rate	6°C/second max.	6°C/second max.
Time 25 °C to peak temperature	6 minutes max.	8 minutes max.

Note : All temperatures refer to topside of the package, measured on the package body surface.

TO-220 Dimension

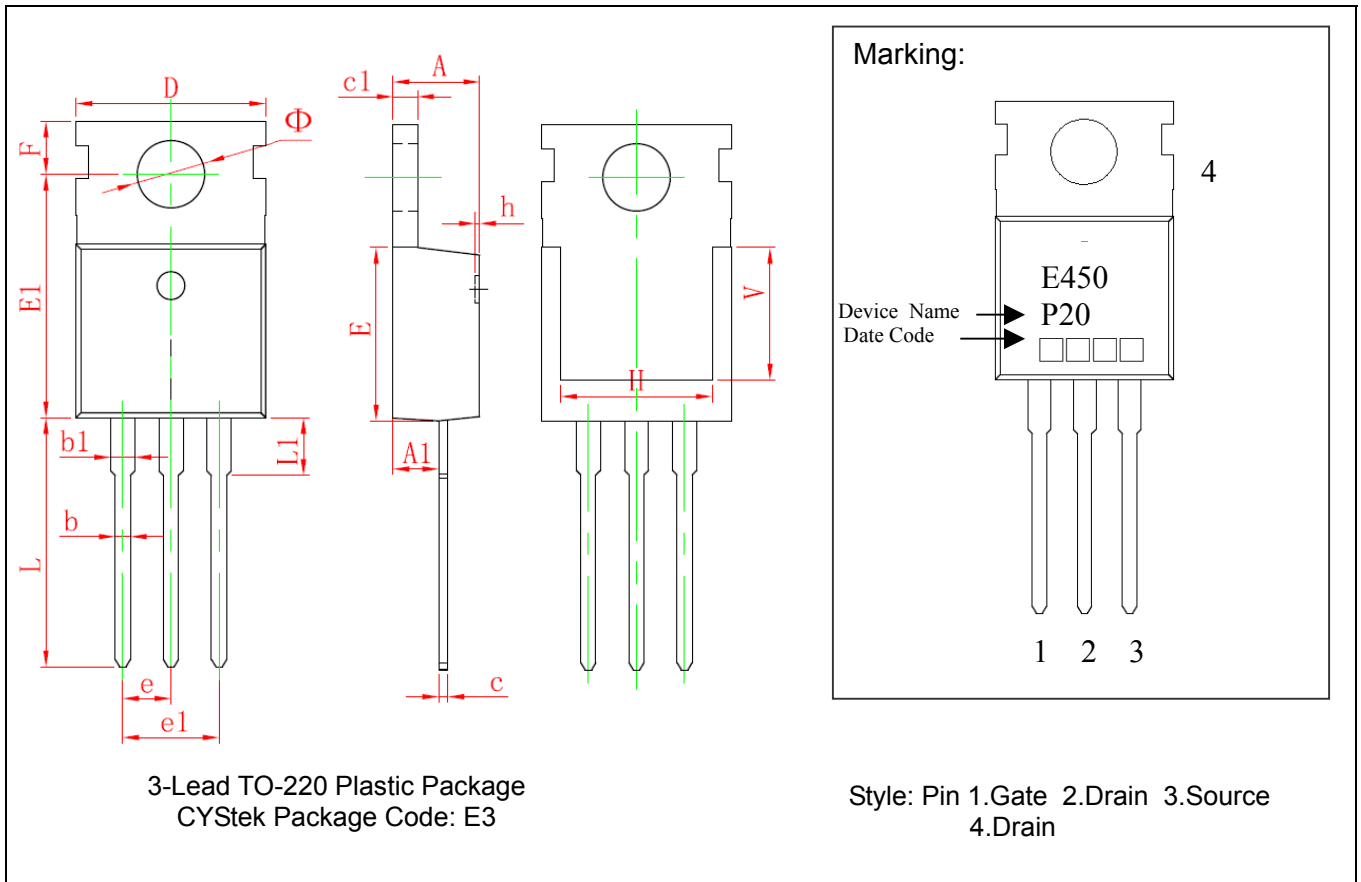

*: Typical

DIM	Millimeters		Inches		DIM	Millimeters		Inches	
	Min.	Max.	Min.	Max.		Min.	Max.	Min.	Max.
A	4.400	4.600	0.173	0.181	e	2.540*		0.100*	
A1	2.250	2.550	0.089	0.100	e1	4.980	5.180	0.196	0.204
b	0.710	0.910	0.028	0.036	F	2.650	2.950	0.104	0.116
b1	1.170	1.370	0.046	0.054	H	7.900	8.100	0.311	0.319
c	0.330	0.650	0.013	0.026	h	0.000	0.300	0.000	0.012
c1	1.200	1.400	0.047	0.055	L	12.900	13.400	0.508	0.528
D	9.910	10.250	0.390	0.404	L1	2.850	3.250	0.112	0.128
E	8.950	9.750	0.352	0.384	V	7.500	REF	0.295	REF
E1	12.650	12.950	0.498	0.510	Φ	3.400	3.800	0.134	0.150

- Notes: 1.Controlling dimension: millimeters.
 2.Maximum lead thickness includes lead finish thickness, and minimum lead thickness is the minimum thickness of base material.
 3.If there is any question with packing specification or packing method, please contact your local CYStek sales office.

Material:

- Lead: Pure tin plated.
- Mold Compound: Epoxy resin family, flammability solid burning class: UL94V-0.

Important Notice:

- All rights are reserved. Reproduction in whole or in part is prohibited without the prior written approval of CYStek.
- CYStek reserves the right to make changes to its products without notice.
- CYStek **semiconductor products are not warranted to be suitable for use in Life-Support Applications, or systems.**
- CYStek assumes no liability for any consequence of customer product design, infringement of patents, or application assistance.