

# N-Channel Enhancement Mode Power MOSFET

## MTE2D0N10RTL8

### Features

- Low On Resistance
- Low Gate Charge
- Fast Switching Characteristic

$BV_{DSS}$	100V
$I_D@V_{GS}=10V, T_C=25^\circ C$	180A
$I_D@V_{GS}=10V, T_A=25^\circ C$	30A
$R_{DS(ON) typ. @V_{GS}=10V, I_D=30A}$	2mΩ

### Equivalent Circuit

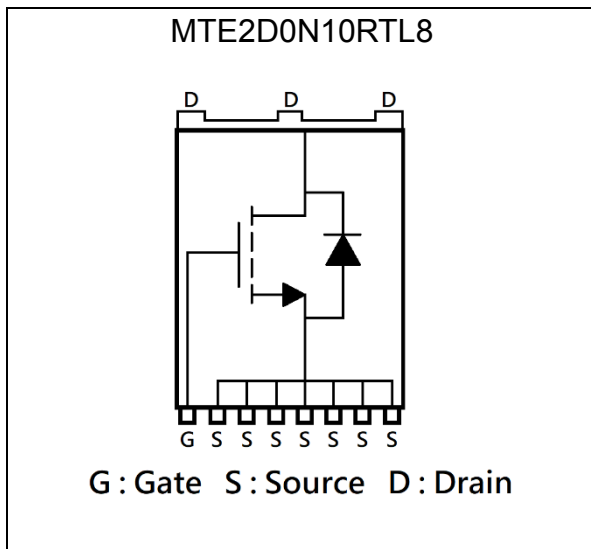

### Outline

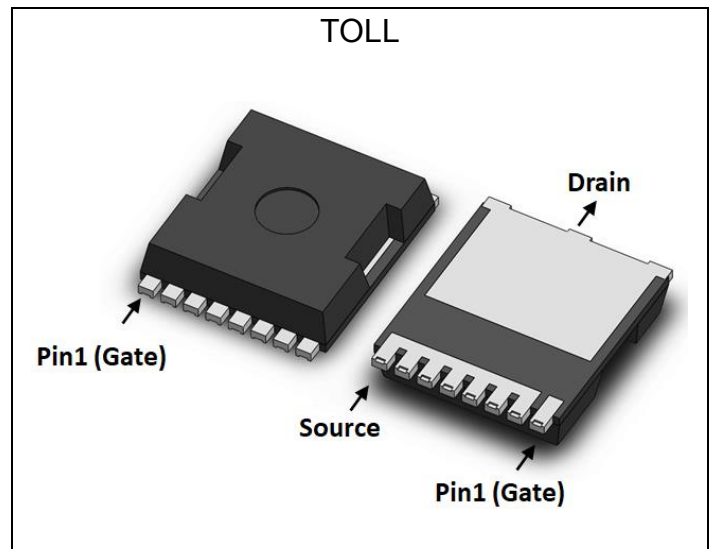

### Ordering Information

Device	Package	Shipping
MTE2D0N10RTL8-0-TK-G	TOLL (RoHS compliant)	2000 pcs / Tape & Reel

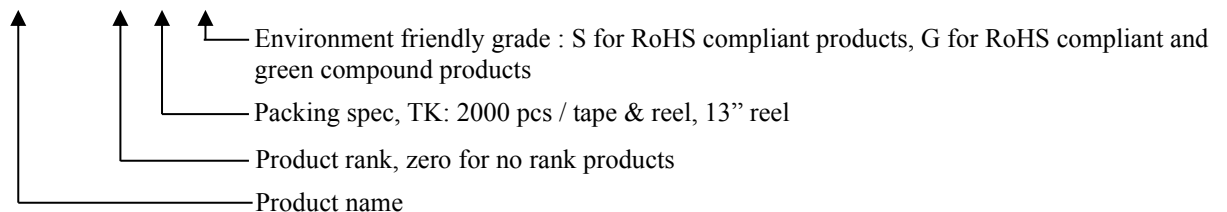



**Absolute Maximum Ratings (TA=25°C)**

Parameter	Symbol	Limits	Unit	
Drain-Source Voltage	V <sub>DS</sub>	100	V	
Gate-Source Voltage	V <sub>GS</sub>	±20		
Continuous Drain Current @ V <sub>GS</sub> =10V, T <sub>C</sub> =25°C	I <sub>D</sub>	180	A	
Continuous Drain Current @ V <sub>GS</sub> =10V, T <sub>C</sub> =100°C		114		
Continuous Drain Current @ V <sub>GS</sub> =10V, T <sub>A</sub> =25°C		30		
Continuous Drain Current @ V <sub>GS</sub> =10V, T <sub>A</sub> =70°C		24		
Pulsed Drain Current		I <sub>DM</sub>		720
Continuous Body Diode Forward Current @ T <sub>C</sub> =25°C	I <sub>S</sub>	115		
Avalanche Current @ L=0.1mH	I <sub>AS</sub>	30		
Avalanche Energy @ L=0.5mH	E <sub>AS</sub>	72	mJ	
Total Power Dissipation	P <sub>D</sub>	T <sub>C</sub> =25°C	138	W
		T <sub>C</sub> =100°C	55	
		T <sub>A</sub> =25°C	4	
		T <sub>A</sub> =70°C	2.6	
Operating Junction and Storage Temperature Range	T <sub>J</sub> , T <sub>stg</sub>	-55~+150	°C	

**Thermal Data**

Parameter	Symbol	Steady State	Unit
Thermal Resistance, Junction-to-case	R <sub>θJC</sub>	0.9	°C/W
Thermal Resistance, Junction-to-ambient	R <sub>θJA</sub>	31	

Note:

- \*a. The power dissipation P<sub>D</sub> is based on T<sub>J(MAX)</sub>=150°C, using junction-to-case thermal resistance, and is more useful in setting the upper dissipation limit for cases where additional heatsinking is used.
- \*b. The value of R<sub>θJA</sub> is measured with the device mounted on 1 in<sup>2</sup> FR-4 board with 2 oz. copper, in a still air environment with T<sub>A</sub>=25°C. The power dissipation P<sub>D</sub> is based on R<sub>θJA</sub> and the maximum allowed junction temperature of 150°C. The value in any given application depends on the user's specific board design.
- \*c. Repetitive rating, pulse width limited by junction temperature T<sub>J(MAX)</sub>=150°C. Ratings are based on low frequency and low duty cycles to keep initial T<sub>J</sub>=25°C.



**Electrical Characteristics (T<sub>A</sub>=25°C, unless otherwise specified)**

Symbol	Min.	Typ.	Max.	Unit	Test Conditions
<b>Static</b>					
BV <sub>DSS</sub>	100	-	-	V	V <sub>GS</sub> =0V, I <sub>D</sub> =250μA
V <sub>GS(th)</sub>	2	-	4		V <sub>DS</sub> =V <sub>GS</sub> , I <sub>D</sub> =250μA
G <sub>FS</sub>	-	52	-	S	V <sub>DS</sub> =5V, I <sub>D</sub> =20A
I <sub>GSS</sub>	-	-	±100	nA	V <sub>GS</sub> =±20V, V <sub>DS</sub> =0V
I <sub>DSS</sub>	-	-	1	μA	V <sub>DS</sub> =80V, V <sub>GS</sub> =0V
R <sub>DS(ON)</sub>	-	2	2.6	mΩ	V <sub>GS</sub> =10V, I <sub>D</sub> =30A
<b>Dynamic</b>					
C <sub>iSS</sub>	-	8100	-	pF	V <sub>DS</sub> =50V, V <sub>GS</sub> =0V, f=1MHz
C <sub>oss</sub>	-	1230	-		
C <sub>rSS</sub>	-	45	-		
R <sub>g</sub>	-	1	-	Ω	f=1MHz
Q <sub>g</sub> *1, 2	-	124	-	nC	V <sub>DS</sub> =50V, I <sub>D</sub> =30A, V <sub>GS</sub> =10V
Q <sub>gs</sub> *1, 2	-	36	-		
Q <sub>gd</sub> *1, 2	-	30	-		
t <sub>d(ON)</sub> *1, 2	-	45	-	ns	V <sub>DS</sub> =50V, I <sub>D</sub> =30A, V <sub>GS</sub> =10V, R <sub>GS</sub> =1Ω
t <sub>r</sub> *1, 2	-	31	-		
t <sub>d(OFF)</sub> *1, 2	-	88	-		
t <sub>f</sub> *1, 2	-	27	-		
<b>Source-Drain Diode</b>					
V <sub>SD</sub> *1	-	0.8	1.2	V	I <sub>S</sub> =30A, V <sub>GS</sub> =0V
t <sub>rr</sub>	-	76	-	ns	I <sub>F</sub> =30A, dI <sub>F</sub> /dt=100A/μs
Q <sub>rr</sub>	-	153	-	nC	

Note:

\*1. Pulse Test : Pulse Width ≤300μs, Duty Cycle≤2%

\*2. Independent of operating temperature



**Typical Characteristics**

Typical Output Characteristics

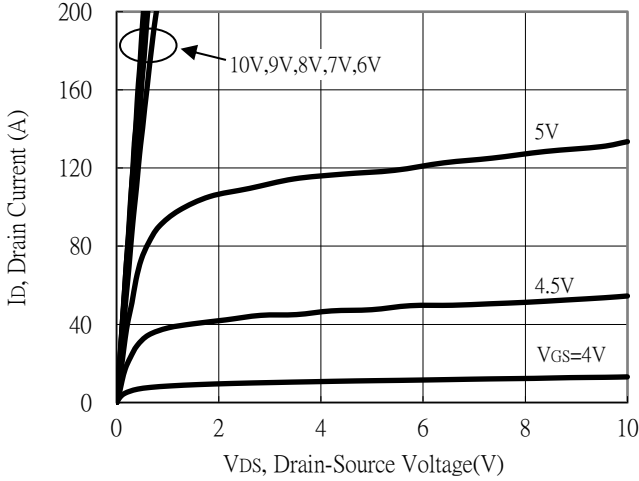

Breakdown Voltage vs Ambient Temperature

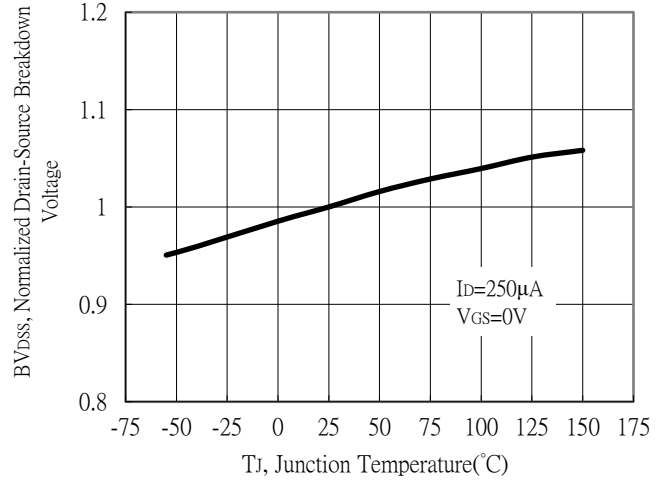

Static Drain-Source On-State resistance vs Drain Current

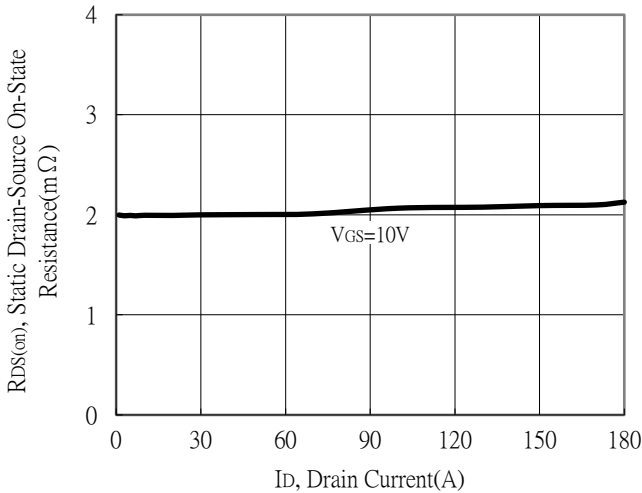

Body Diode Current vs Source-Drain Voltage

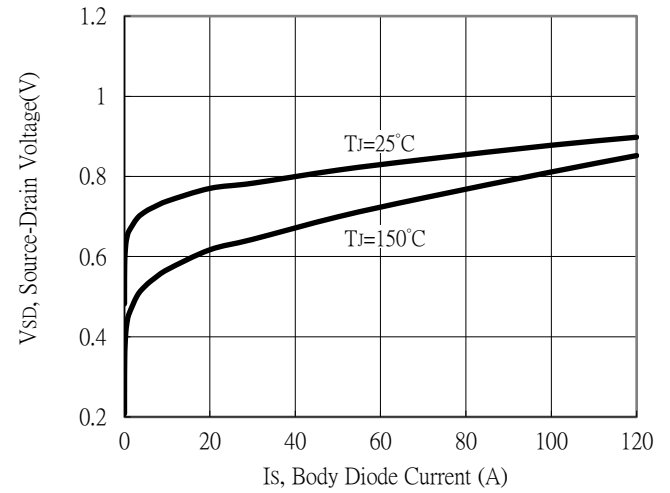

Static Drain-Source On-State Resistance vs Gate-Source Voltage

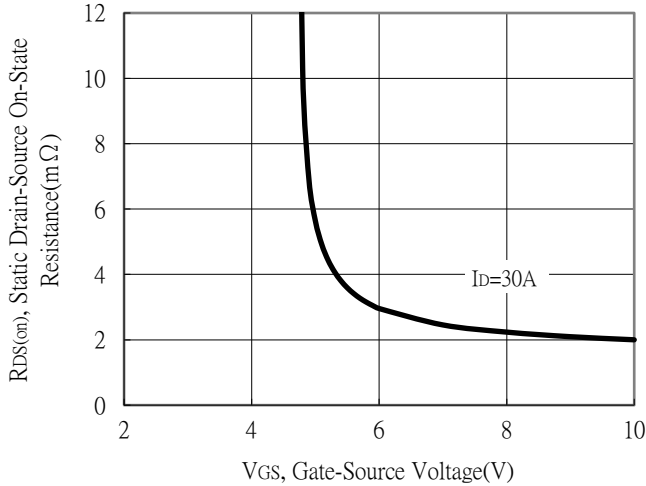

Drain-Source On-State Resistance vs Junction Temperature

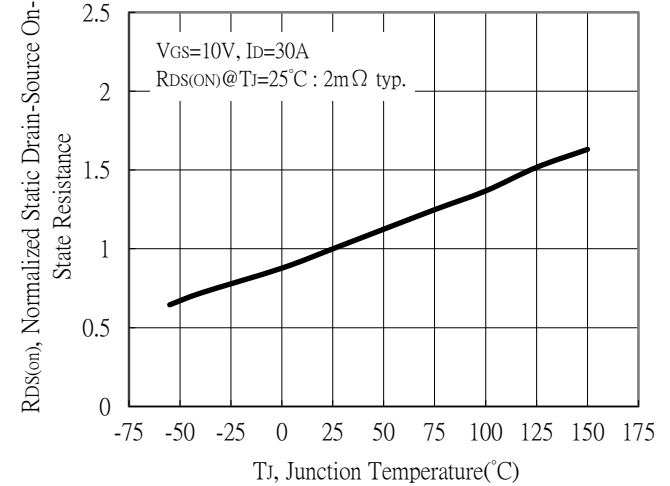



### Typical Characteristics (Cont.)

Capacitance vs Drain-to-Source Voltage

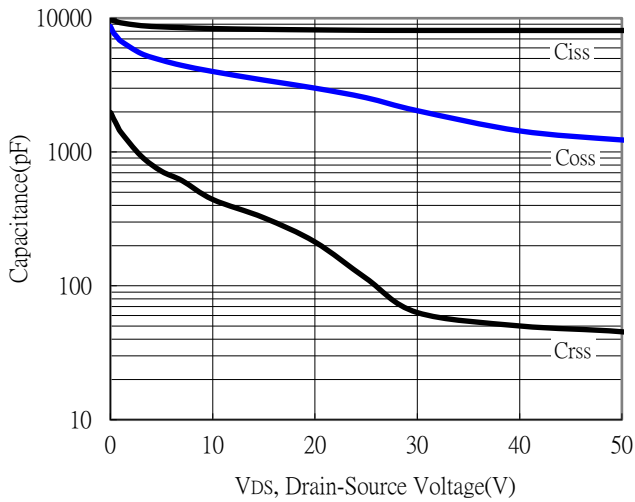

Threshold Voltage vs Junction Temperature

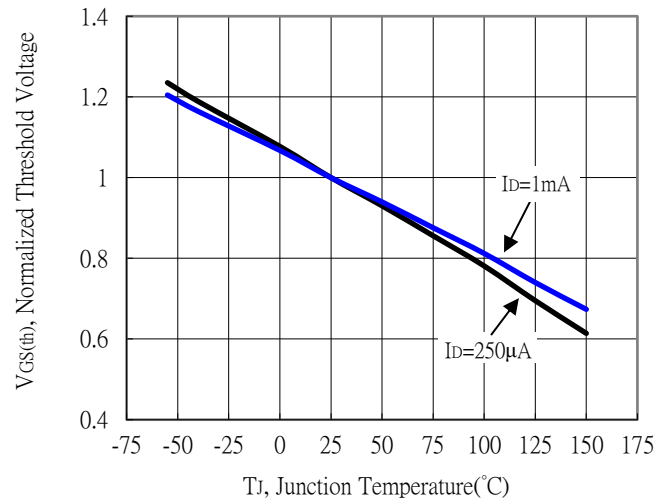

Forward Transfer Admittance vs Drain Current

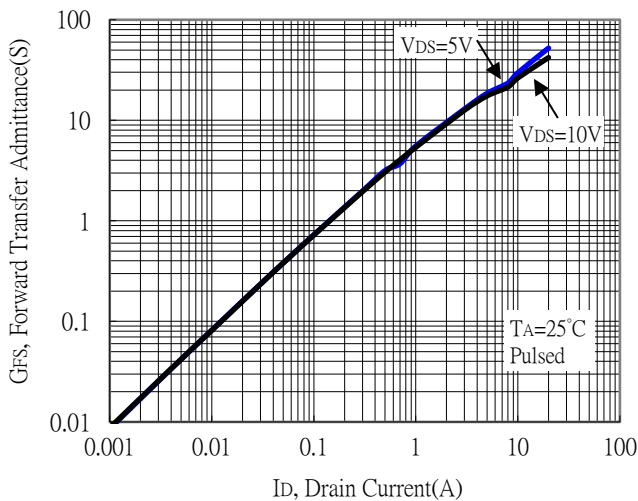

Gate Charge Characteristics

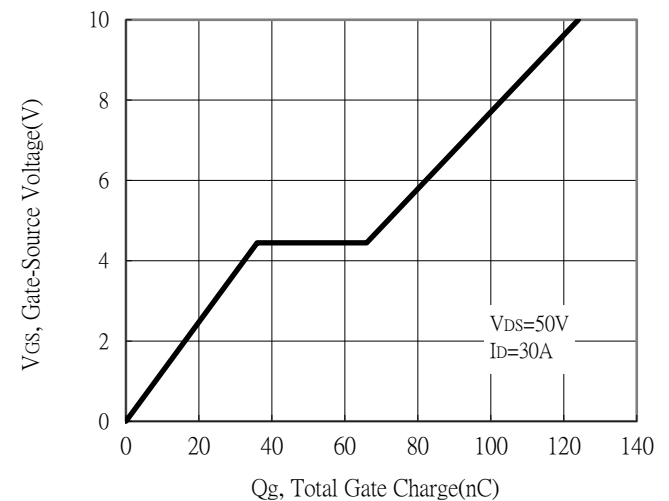

Maximum Safe Operating Area

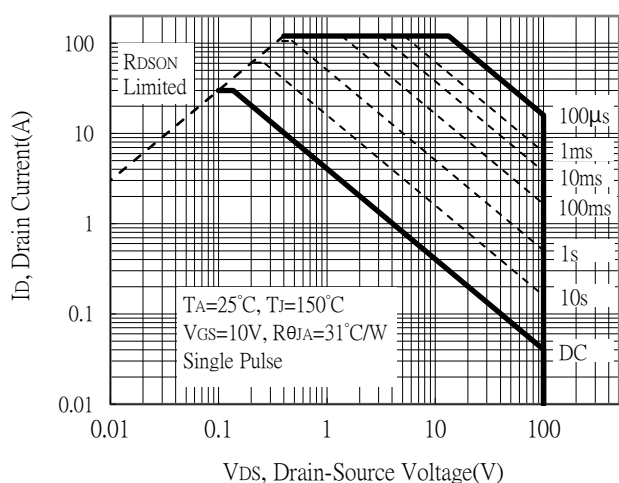

Maximum Drain Current vs Junction Temperature

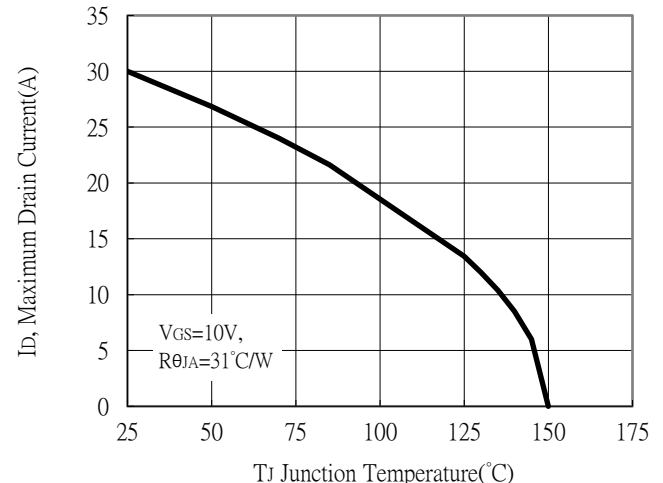

**Typical Characteristics (Cont.)**

Single Pulse Power Rating, Junction to Ambient

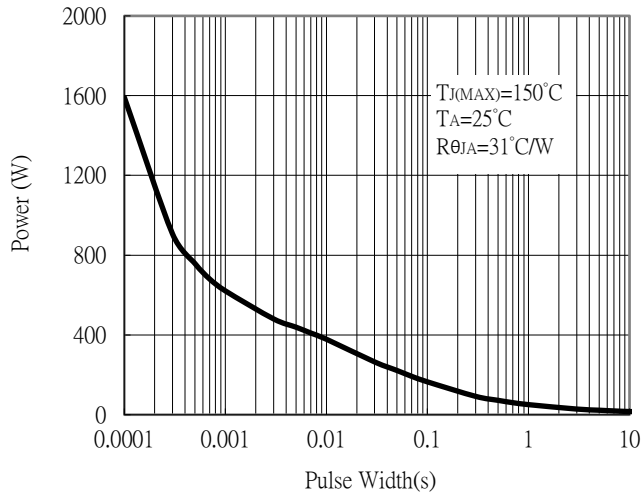

Transient Thermal Response Curves

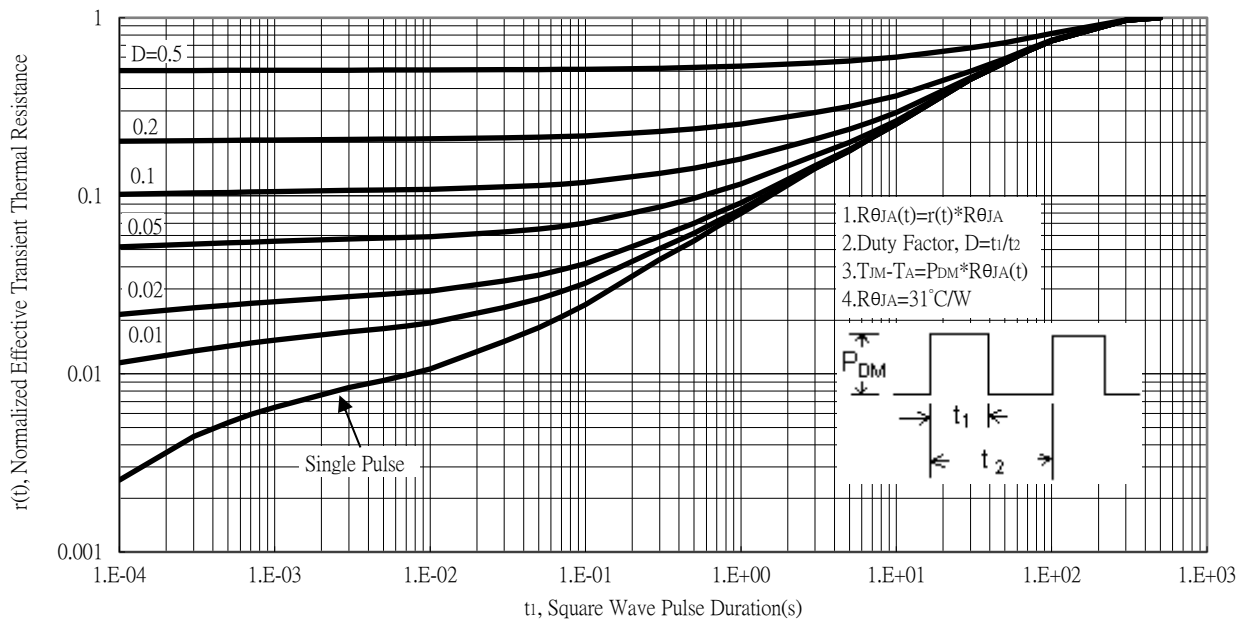

**Recommended Soldering Footprint**

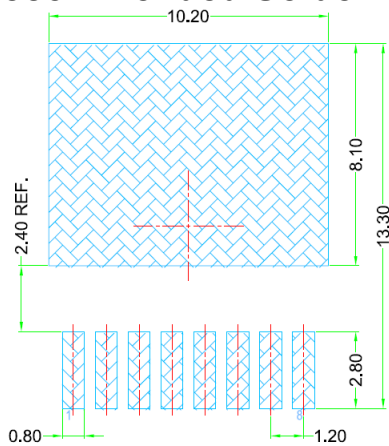

Unit : mm

**Reel Dimension**

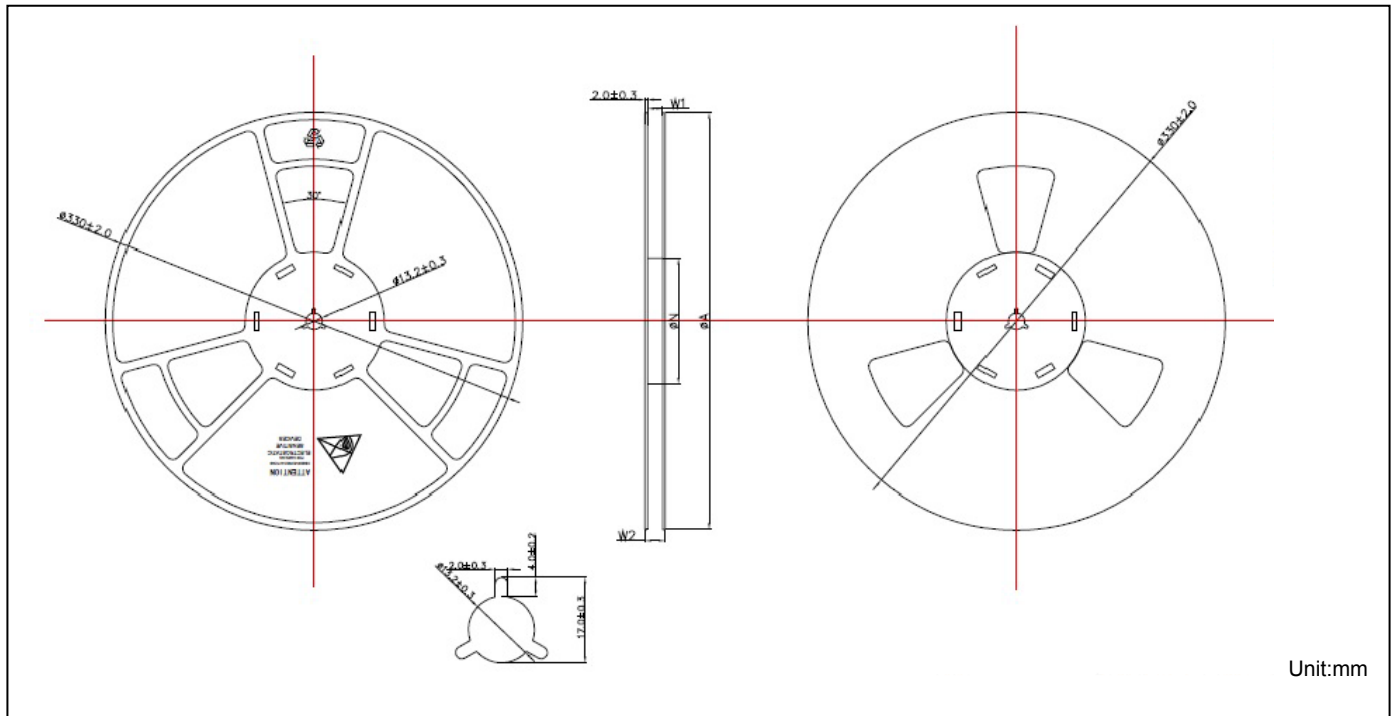

**Carrier Tape Dimension**

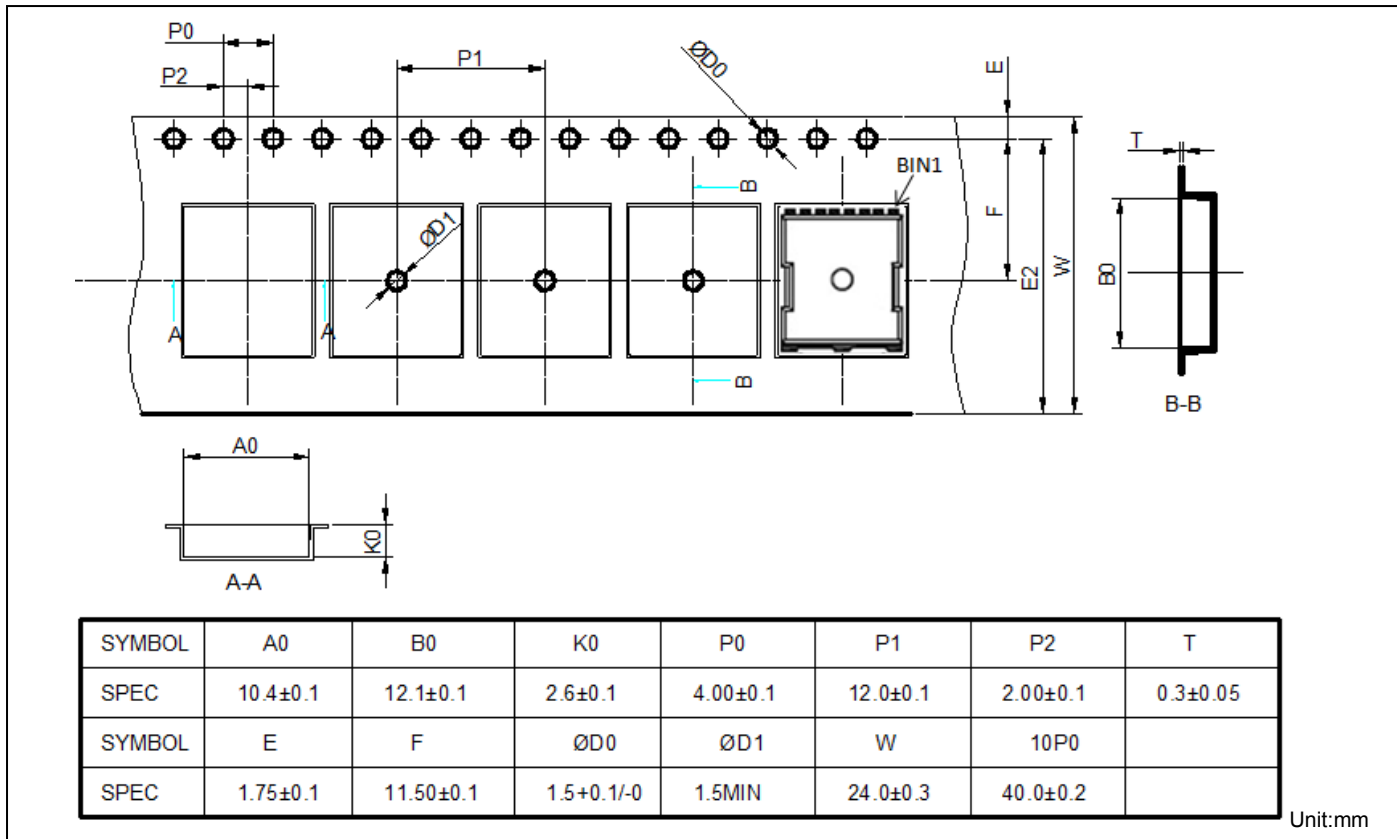

**Recommended wave soldering condition**

Product	Peak Temperature	Soldering Time
Pb-free devices	260 +0/-5 °C	5 +1/-1 seconds

**Recommended temperature profile for IR reflow**



Profile feature	Sn-Pb eutectic Assembly	Pb-free Assembly
Average ramp-up rate (T <sub>smax</sub> to T <sub>p</sub> )	3°C/second max.	3°C/second max.
Preheat		
-Temperature Min(T <sub>s min</sub> )	100°C	150°C
-Temperature Max(T <sub>s max</sub> )	150°C	200°C
-Time(t <sub>s min</sub> to t <sub>s max</sub> )	60-120 seconds	60-180 seconds
Time maintained above:		
-Temperature (T <sub>L</sub> )	183°C	217°C
- Time (t <sub>L</sub> )	60-150 seconds	60-150 seconds
Peak Temperature(T <sub>P</sub> )	240 +0/-5 °C	260 +0/-5 °C
Time within 5°C of actual peak temperature(tp)	10-30 seconds	20-40 seconds
Ramp down rate	6°C/second max.	6°C/second max.
Time 25 °C to peak temperature	6 minutes max.	8 minutes max.

Note : All temperatures refer to topside of the package, measured on the package body surface.



## TOLL Dimension

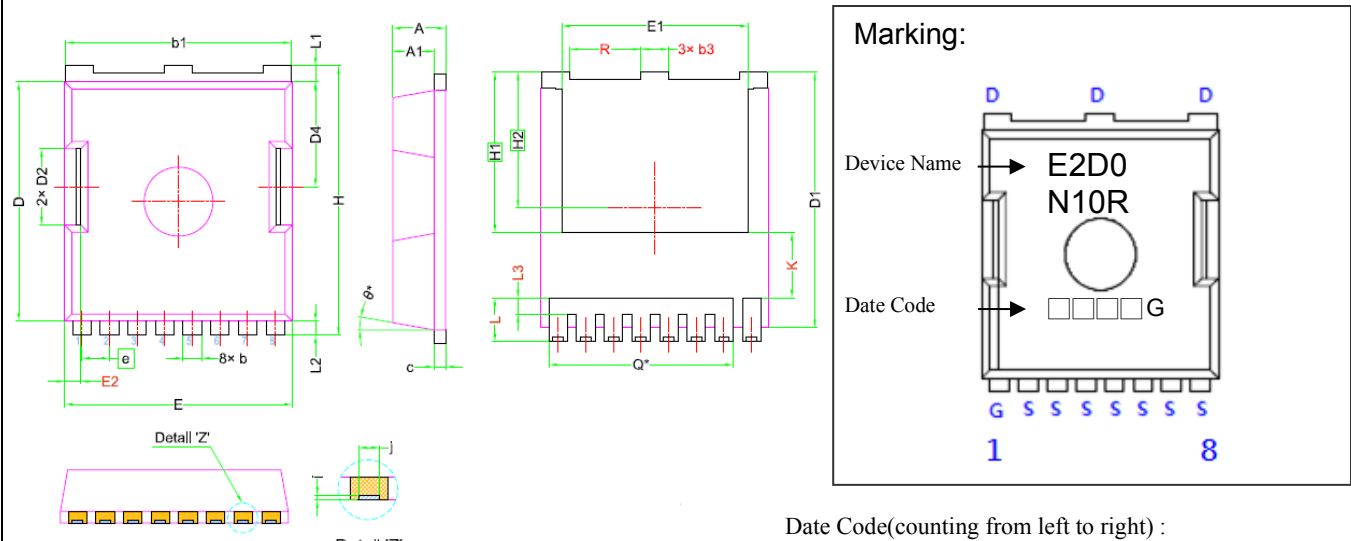

**Marking:**

Device Name → E2D0  
N10R

Date Code → □□□□G

1 8

Style: Pin 1. Gate 2~8.Source Tab Drain  
 3-Lead TOLL Plastic Package  
 CYStek Package Code: TL8

Date Code(counting from left to right) :  
 1<sup>st</sup> code: year code, the last digit of Christian year  
 2<sup>nd</sup> code : month code, Jan→A, Feb→B, Mar→C, Apr→D,  
 May→E, Jun→F, Jul→G, Aug→H, Sep→J,  
 Oct→K, Nov→L, Dec→M  
 3<sup>rd</sup> and 4<sup>th</sup> codes : production serial number, 01~99

DIM	Millimeters		Inches		DIM	Millimeters		Inches	
	Min.	Max.	Min.	Max.		Min.	Max.	Min.	Max.
A	2.20	2.40	0.086	0.094	H	11.58	11.78	0.455	0.463
A1	1.70	1.90	0.066	0.074	H1	6.95 BSC		0.273 BSC	
b	0.70	0.90	0.027	0.035	H2	5.89 BSC		0.231 BSC	
b1	9.70	9.90	0.381	0.389	i	0.10 REF.		0.003 REF.	
b3	1.10	1.30	0.043	0.051	j	0.46 REF.		0.018 REF.	
c	0.40	0.60	0.015	0.023	K	2.80 REF.		0.110 REF.	
D	10.28	10.48	0.404	0.412	L	1.40	2.10	0.055	0.082
D1	10.98	11.18	0.432	0.440	L1	0.60	0.80	0.023	0.031
D2	3.20	3.40	0.125	0.133	L2	0.50	0.70	0.019	0.027
D4	4.45	4.65	0.175	0.183	L3	0.30	0.80	0.011	0.031
E	9.80	10.00	0.385	0.393	N	8		0.314	
E1	8.00	8.20	0.314	0.322	Q	8.00 REF.		0.314 REF.	
E2	0.60	0.80	0.023	0.031	R	3.00	3.20	0.118	0.125
e	1.20 BSC		0.047 BSC		θ	10° REF.		10° REF.	

Notes: 1.Controlling dimension: millimeters.  
 2.Maximum lead thickness includes lead finish thickness, and minimum lead thickness is the minimum thickness of base material.  
 3.If there is any question with packing specification or packing method, please contact your local CYStek sales office.

### Material:

- Lead: Pure tin plated.
- Mold Compound: Epoxy resin family, flammability solid burning class: UL94V-0.

### Important Notice:

- All rights are reserved. Reproduction in whole or in part is prohibited without the prior written approval of CYStek.
- CYStek reserves the right to make changes to its products without notice.
- CYStek **semiconductor products are not warranted to be suitable for use in Life-Support Applications, or systems.**
- CYStek assumes no liability for any consequence of customer product design, infringement of patents, or application assistance.