

N-Channel Enhancement Mode Power MOSFET

MTE2D0N10RF3

Features

- Low On Resistance
- Low Gate Charge
- Fast Switching Characteristic
- RoHS compliant package

BV_{DSS}	100V
$I_D@V_{GS}=10V, T_C=25^\circ C$ (silicon limit)	145A
$I_D@V_{GS}=10V, T_C=25^\circ C$ (package limit)	85A
$I_D@V_{GS}=10V, T_A=25^\circ C$	30A
$R_{DS(on)(typ)}@V_{GS}=10V, I_D=30A$	2.5 m Ω

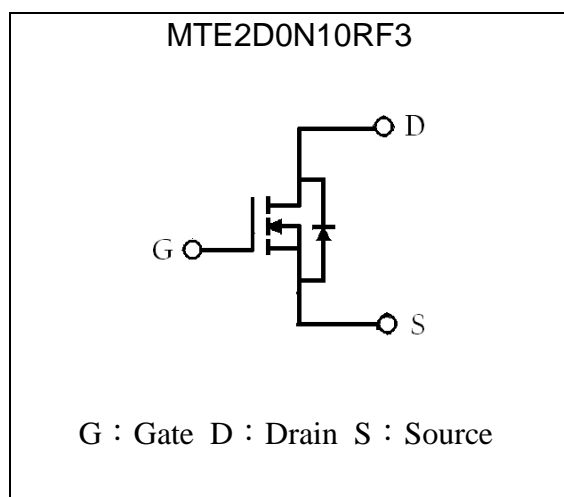
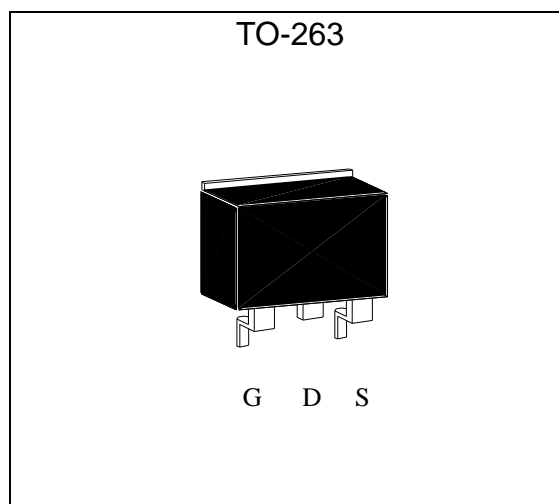
Symbol

Outline

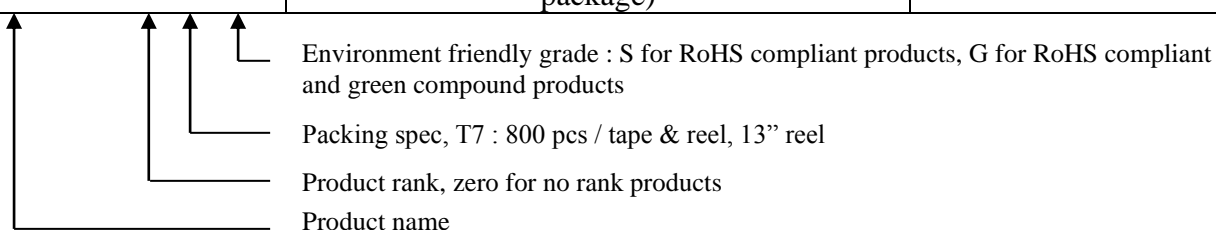
Ordering Information

Device	Package	Shipping
MTE2D0N10RF3-0-T7-G	TO-263 (Pb-free lead plating and RoHS compliant package)	800 pcs / Tape & Reel



**Absolute Maximum Ratings** (Ta=25°C)

Parameter	Symbol	Limits	Unit	
Drain-Source Voltage	V _{DS}	100	V	
Gate-Source Voltage	V _{GS}	±20		
Continuous Drain Current @ T _C =25°C, V _{GS} =10V(silicon limit)	I _D	145 *1	A	
Continuous Drain Current @ T _C =100°C, V _{GS} =10V(silicon limit)		100 *1		
Continuous Drain Current @ T _C =25°C, V _{GS} =10V(package limit)		85		
Continuous Drain Current @ T _A =25°C, V _{GS} =10V		30 *2		
Continuous Drain Current @ T _A =70°C, V _{GS} =10V		25 *2		
Pulsed Drain Current	I _{DM}	340 *3		
Avalanche Current @ L=0.1mH	I _{AS}	30		
Avalanche Energy @ L=0.5mH	E _{AS}	72	mJ	
Total Power Dissipation	P _D	T _C =25°C	115 *1	W
		T _C =100°C	58 *1	
	P _{DSM}	T _A =25°C	4.7 *2, 4	
		T _A =70°C	3.3 *2, 4	
Operating Junction and Storage Temperature Range	T _j , T _{stg}	-55~+175	°C	

Thermal Data

Parameter	Symbol	Value	Unit
Thermal Resistance, Junction-to-case, max	R _{θJC}	1.32	°C/W
Thermal Resistance, Junction-to-ambient, max (Note 2)	R _{θJA}	32 *4	

- Note : 1. The power dissipation P_D is based on T_{J(MAX)}=175°C, using junction-to-case thermal resistance, and is more useful in setting the upper dissipation limit for cases where additional heatsinking is used.
2. The value of R_{θJA} is measured with the device mounted on 1 in² FR-4 board with 2 oz. copper, in a still air environment with T_A=25°C. The value in any given application depends on the user's specific board design. The power dissipation P_{DSM} is based on R_{θJA} and the maximum allowed junction temperature of 150°C.
3. Ratings are based on low frequency and low duty cycles to keep initial T_J=25°C.
4. When mounted on 1 in² copper pad of FR-4 board ; 125°C/W when mounted on minimum copper pad.



Characteristics (Tc=25°C, unless otherwise specified)

Symbol	Min.	Typ.	Max.	Unit	Test Conditions
Static					
BV _{DSS}	100	-	-	V	V _{GS} =0V, I _D =250μA
V _{GS(th)}	2	-	4		V _{DS} =V _{GS} , I _D =250μA
G _{FS} *1	-	52.3	-	S	V _{DS} =5V, I _D =20A
I _{GSS}	-	-	±100	nA	V _{GS} =±20V, V _{DS} =0V
I _{DSS}	-	-	1	μA	V _{DS} =80V, V _{GS} =0V
	-	-	10		V _{DS} =80V, V _{GS} =0V, T _J =85°C
R _{DS(ON)} *1	-	2.5	3.2	mΩ	V _{GS} =10V, I _D =30A
Dynamic					
C _{iss}	-	8100	-	pF	V _{DS} =50V, V _{GS} =0V, f=1MHz
C _{oss}	-	1230	-		
C _{rss}	-	45	-		
Q _g *1, 2	-	125	-	nC	V _{DS} =80V, I _D =30A, V _{GS} =10V
Q _{gs} *1, 2	-	35	-		
Q _{gd} *1, 2	-	30	-		
t _{d(ON)} *1, 2	-	45	-	ns	V _{DS} =50V, I _D =30A, V _{GS} =10V, R _{GS} =1Ω
t _r *1, 2	-	30	-		
t _{d(OFF)} *1, 2	-	88	-		
t _f *1, 2	-	27	-		
R _g	-	1.0	-	Ω	f=1MHz
Source-Drain Diode					
I _S *1	-	-	30	A	
I _{SM} *3	-	-	120		
V _{SD} *1	-	0.8	1.2	V	I _S =30A, V _{GS} =0V
t _{rr}	-	75	-	ns	I _F =30A, dI _F /dt=100A/μs
Q _{rr}	-	150	-	nC	

Note : *1.Pulse Test : Pulse Width ≤300μs, Duty Cycle≤2%
 *2.Independent of operating temperature
 *3.Pulse width limited by maximum junction temperature.

Typical Characteristics

Typical Output Characteristics

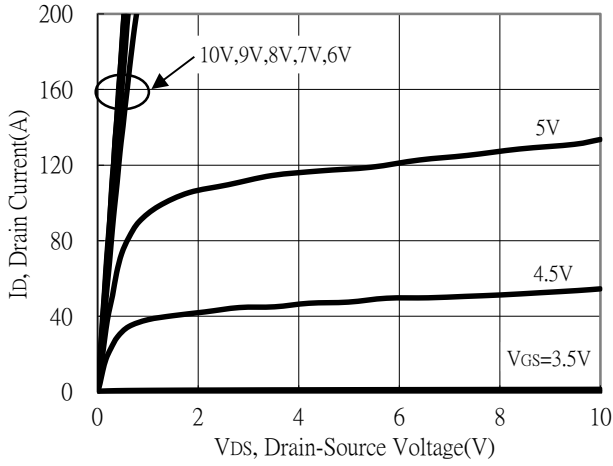

Breakdown Voltage vs Ambient Temperature

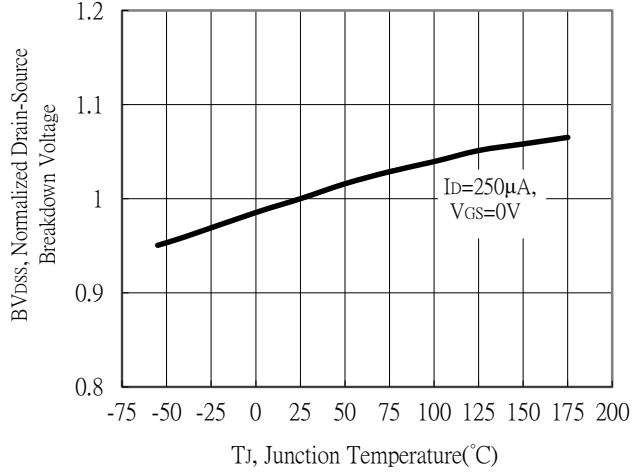

Static Drain-Source On-State resistance vs Drain Current

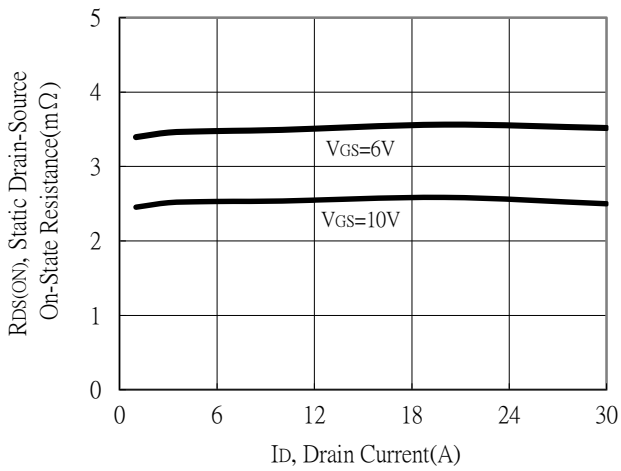

Reverse Drain Current vs Source-Drain Voltage

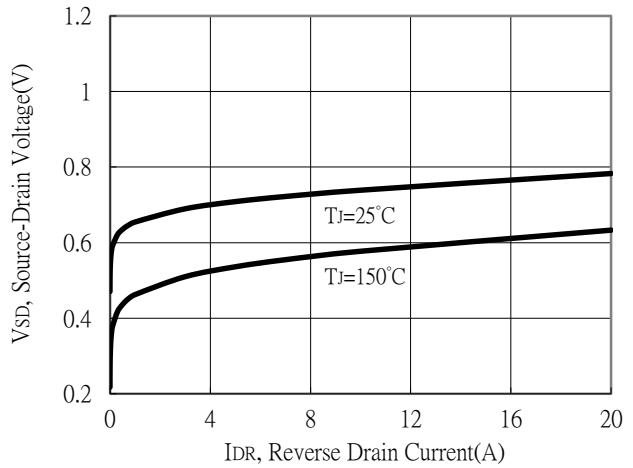

Static Drain-Source On-State Resistance vs Gate-Source Voltage

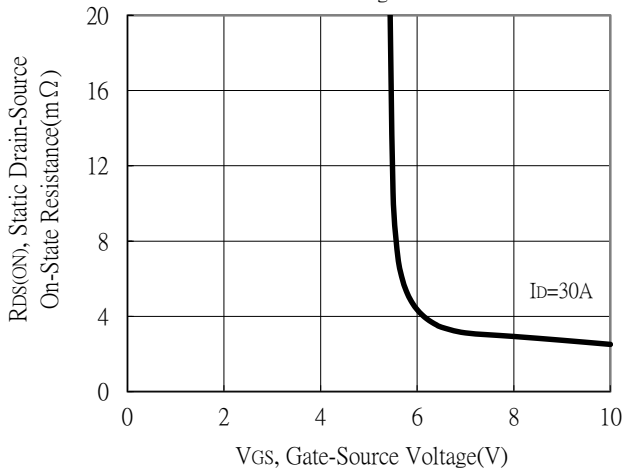

Drain-Source On-State Resistance vs Junction Temperature

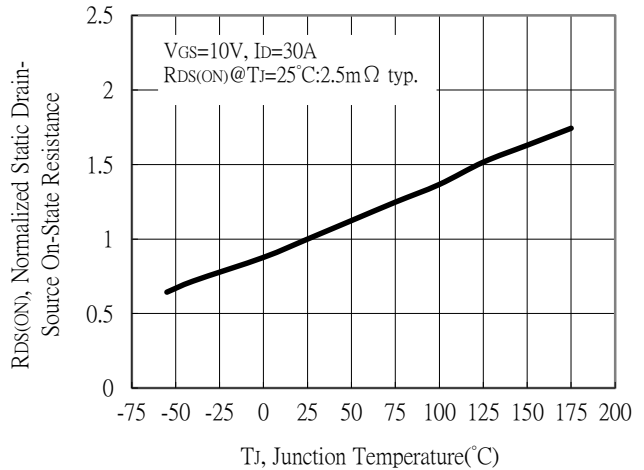

Typical Characteristics(Cont.)

Capacitance vs Drain-to-Source Voltage

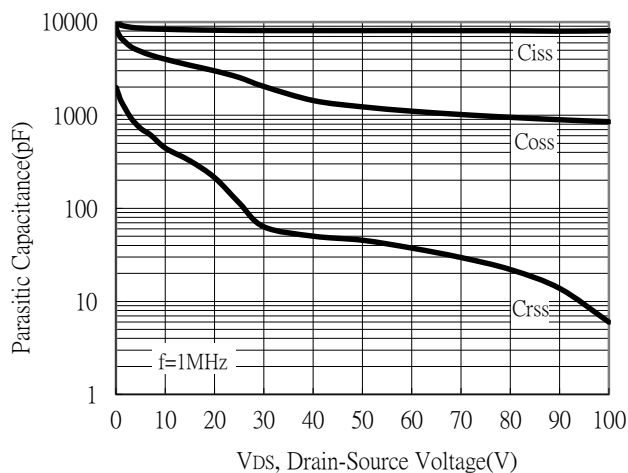

Threshold Voltage vs Junction Temperature

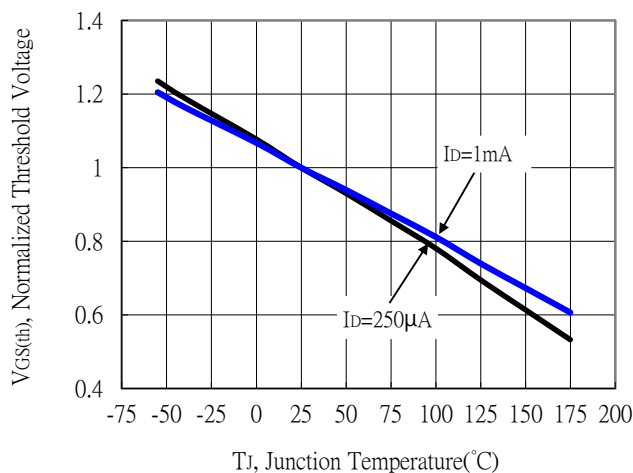

Forward Transfer Admittance vs Drain Current

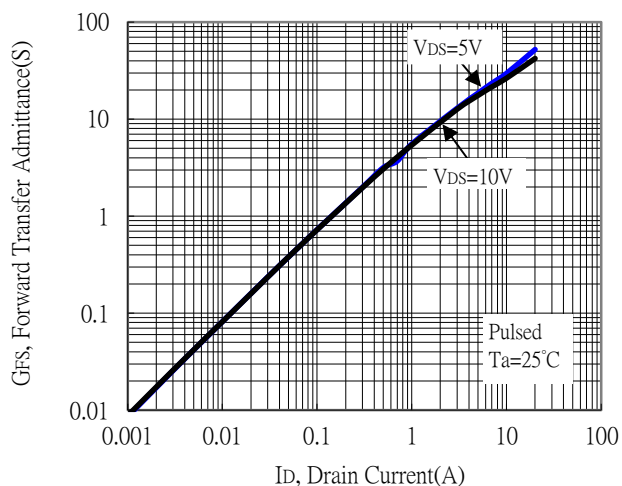

Gate Charge Characteristics

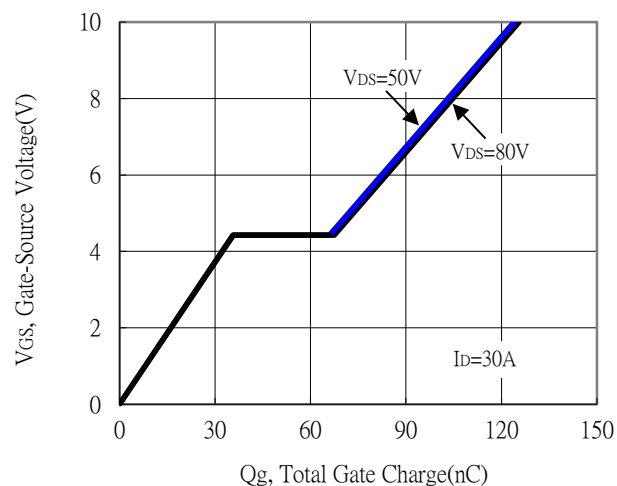

Maximum Safe Operating Area

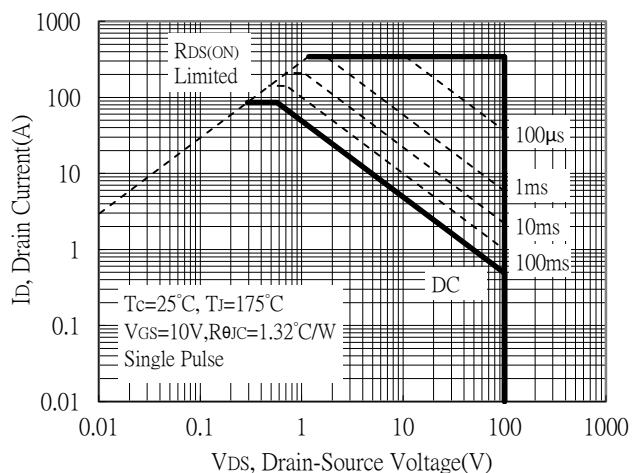

Maximum Drain Current vs Case Temperature

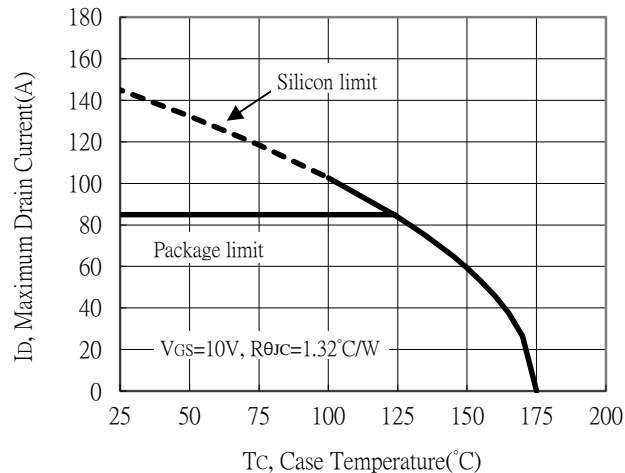

Typical Characteristics(Cont.)

Single Pulse Maximum Power Dissipation

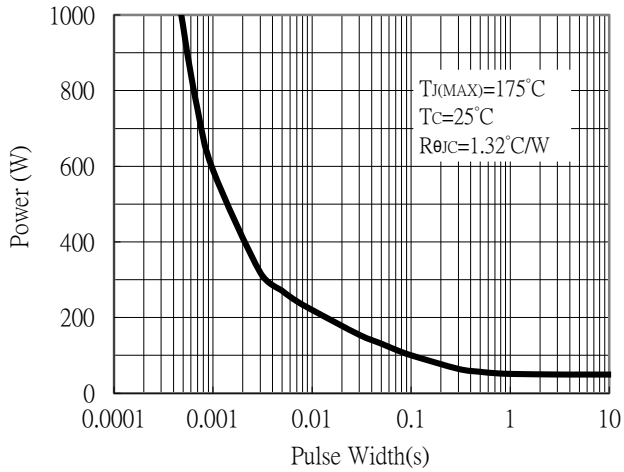

Power Derating Curve

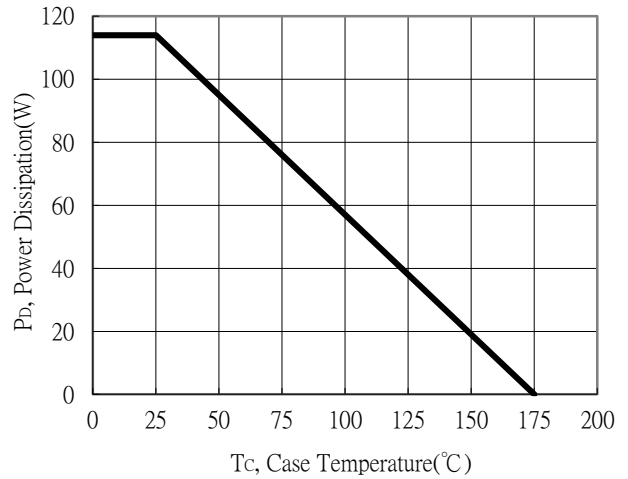

Transient Thermal Response Curves

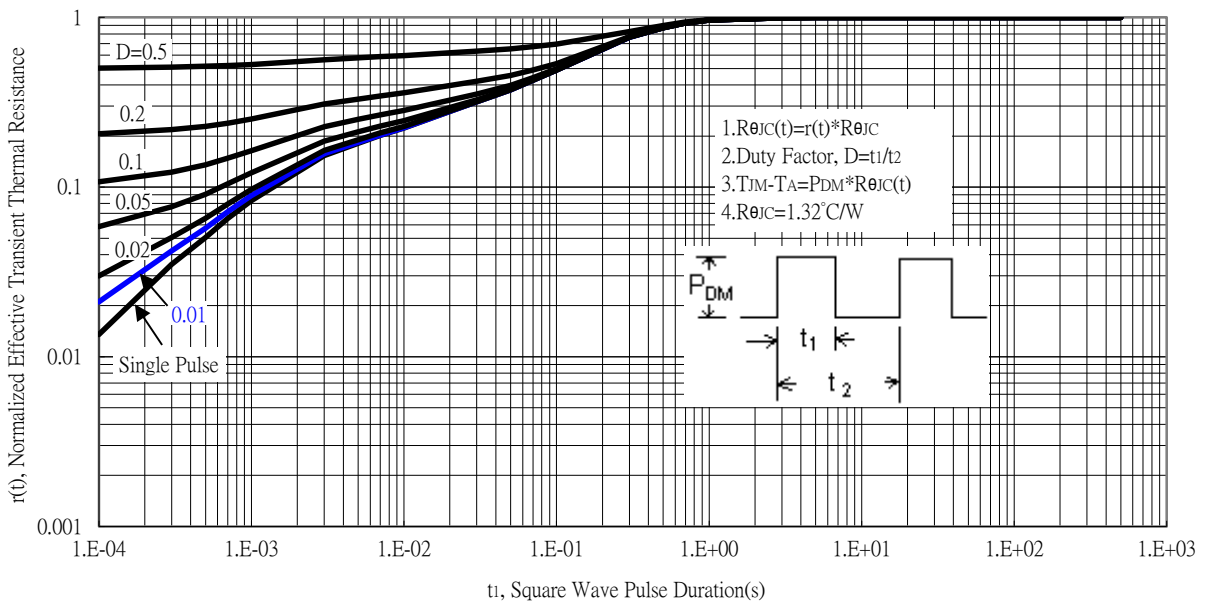

Reel Dimension

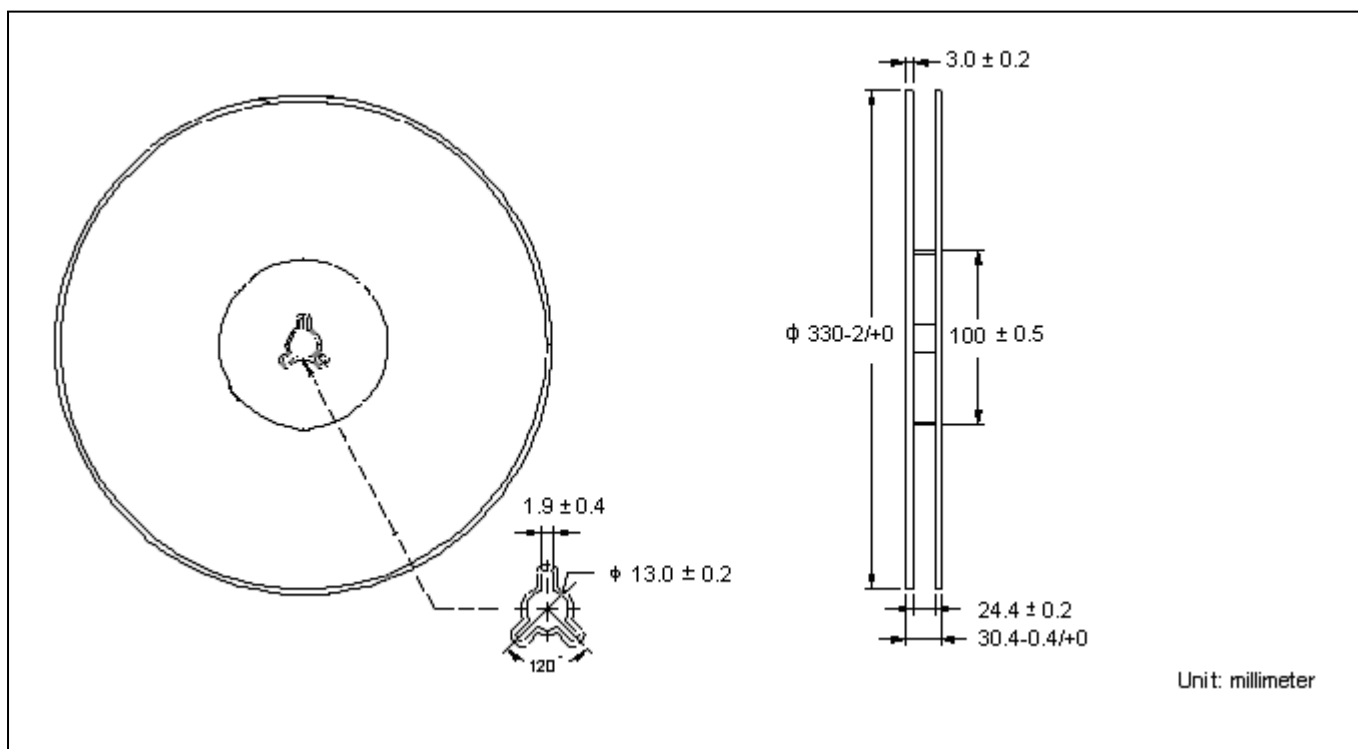

Carrier Tape Dimension

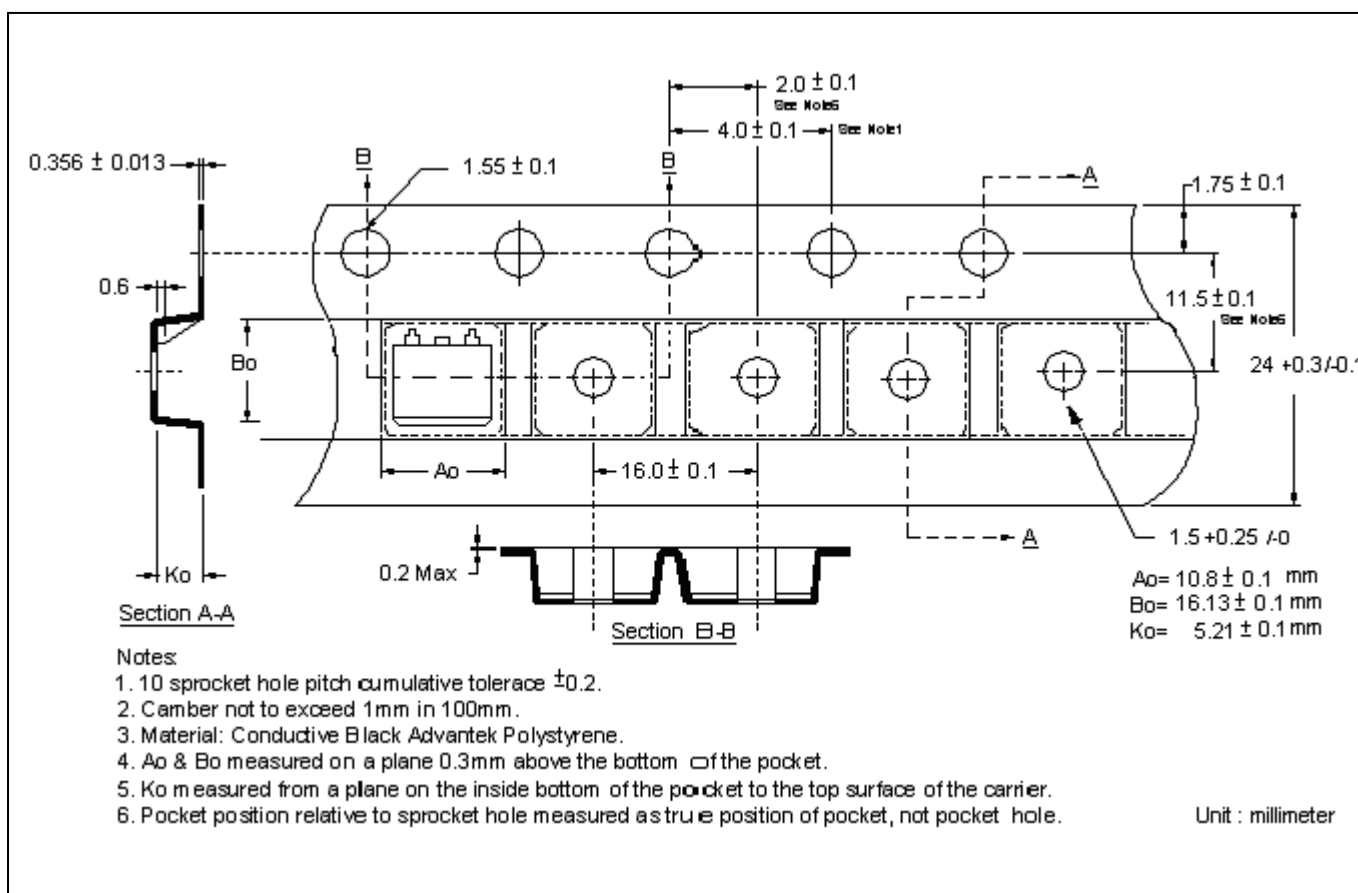

Recommended wave soldering condition

Product	Peak Temperature	Soldering Time
Pb-free devices	260 +0/-5 °C	5 +1/-1 seconds

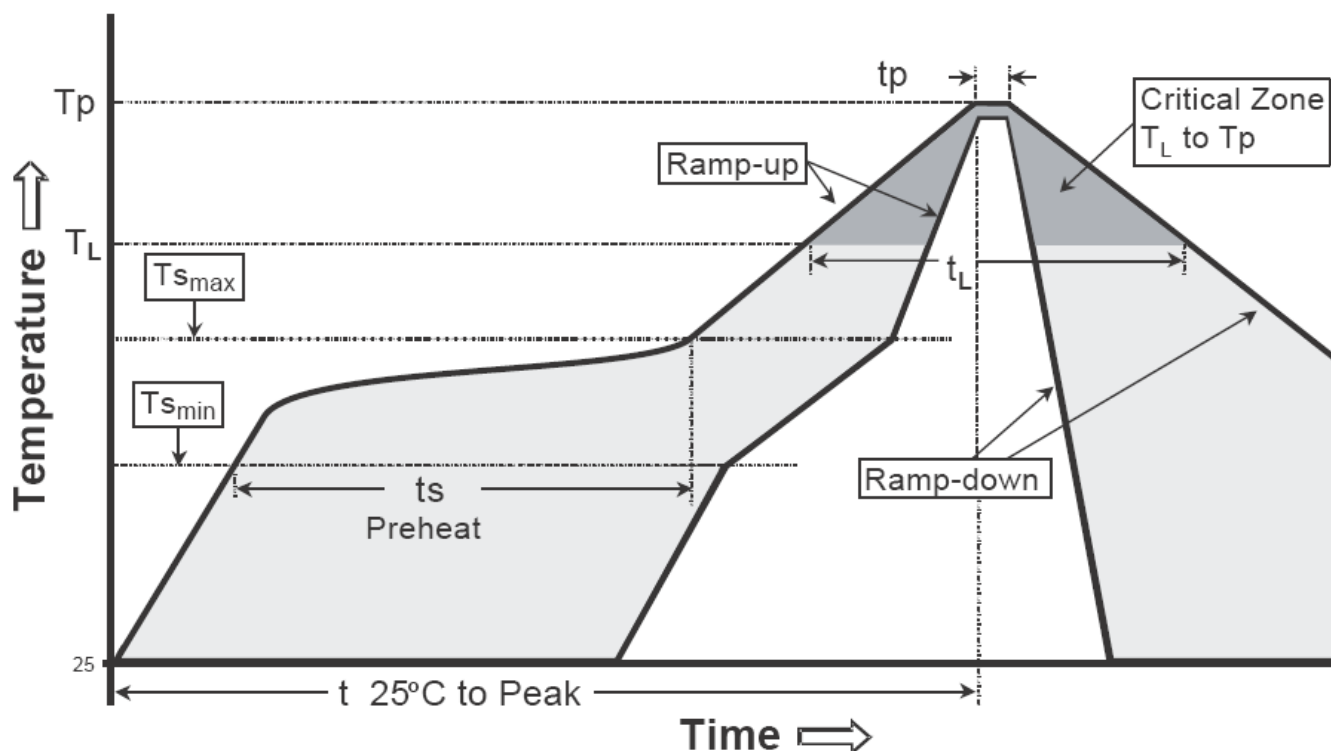
Recommended temperature profile for IR reflow

Profile feature	Sn-Pb eutectic Assembly	Pb-free Assembly
Average ramp-up rate (T _{smax} to T _p)	3°C/second max.	3°C/second max.
Preheat		
-Temperature Min(T _{s min})	100°C	150°C
-Temperature Max(T _{s max})	150°C	200°C
-Time(t _{s min} to t _{s max})	60-120 seconds	60-180 seconds
Time maintained above:		
-Temperature (T _L)	183°C	217°C
- Time (t _L)	60-150 seconds	60-150 seconds
Peak Temperature(T _P)	240 +0/-5 °C	260 +0/-5 °C
Time within 5°C of actual peak temperature(t _p)	10-30 seconds	20-40 seconds
Ramp down rate	6°C/second max.	6°C/second max.
Time 25 °C to peak temperature	6 minutes max.	8 minutes max.

Note : All temperatures refer to topside of the package, measured on the package body surface.

TO-263 Dimension

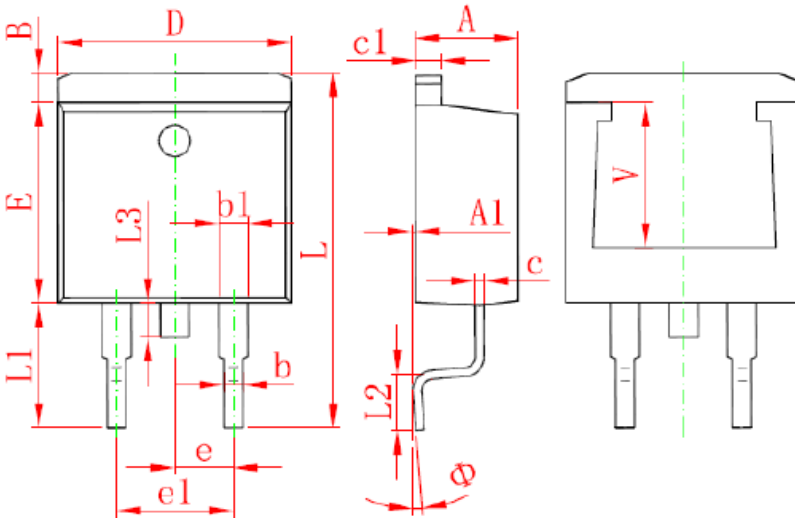

The diagram shows three views of the TO-263 package: a top view, a side view, and a bottom view. Dimensions are labeled with letters and numbers: A, A1, B, c1, D, E, L, L1, L2, L3, b, b1, c, e, e1, and Φ. The top view shows a rectangular package with a central circular mark and three leads extending downwards. The side view shows the package's profile with a lead extending from the side. The bottom view shows the underside of the package with a central rectangular mark and three leads extending downwards.

Marking :

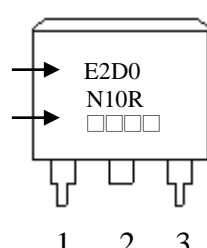

Device Code → E2D0
 Date Code → N10R
 □ □ □ □

1 2 3

Style : Pin 1.Gate 2.Drain
 3.Source

3-Lead Plastic Surface Mounted Package
 CYStek Package Code : F3

Date Code : (From left to right)
 First Code : Year code, the last digit of Christian year. For example, 2014→4, 2015→, 2016→6, ..., etc.
 Second Code : Month code, Jan→A, Feb→B, Mar→C, Apr→D, May→E, Jun→F, Jul→G, Aug→H, Sep→J,
 Oct→K, Nov→L, Dec→M
 Third and fourth codes : production serial number, 01~99

DIM	Millimeters		Inches		DIM	Millimeters		Inches	
	Min.	Max.	Min.	Max.		Min.	Max.	Min.	Max.
A	4.470	4.670	0.176	0.184	e	2.540	TYP	0.100	TYP
A1	0.000	0.150	0.000	0.006	e1	4.980	5.180	0.196	0.204
B	1.120	1.420	0.044	0.056	L	14.940	15.500	0.588	0.610
b	0.710	0.910	0.028	0.036	L1	4.950	5.450	0.195	0.215
b1	1.170	1.370	0.046	0.054	L2	2.340	2.740	0.092	0.108
c	0.310	0.530	0.012	0.021	L3	1.300	1.700	0.051	0.067
c1	1.170	1.370	0.046	0.054	Φ	0°	8°	0°	8°
D	10.010	10.310	0.394	0.406	V	6.400	REF	0.253	REF
E	8.500	8.900	0.335	0.350					

Notes : 1.Controlling dimension : millimeters.
 2.Maximum lead thickness includes lead finish thickness, and minimum lead thickness is the minimum thickness of base material.
 3.If there is any question with packing specification or packing method, please contact your local CYStek sales office.

Material :

- Lead : Pure tin plated.
- Mold Compound : Epoxy resin family, flammability solid burning class:UL94V-0.

Important Notice:

- All rights are reserved. Reproduction in whole or in part is prohibited without the prior written approval of CYStek.
- CYStek reserves the right to make changes to its products without notice.
- CYStek **semiconductor products are not warranted to be suitable for use in Life-Support Applications, or systems.**
- CYStek assumes no liability for any consequence of customer product design, infringement of patents, or application assistance.