

# N-Channel Enhancement Mode Power MOSFET

## MTE1D8N04E3

<b>BV<sub>DSS</sub></b>	<b>40V</b>
<b>I<sub>D</sub>@V<sub>GS</sub>=10V, T<sub>C</sub>=25°C</b>	<b>180A</b>
<b>I<sub>D</sub>@V<sub>GS</sub>=10V, T<sub>A</sub>=25°C</b>	<b>20A</b>
<b>R<sub>DS(ON)</sub>@V<sub>GS</sub>=10V, I<sub>D</sub>=50A</b>	<b>1.8mΩ (typ)</b>

### Features

- Low On Resistance
- Simple Drive Requirement
- Low Gate Charge
- Fast Switching Characteristic
- RoHS compliant package

### Symbol

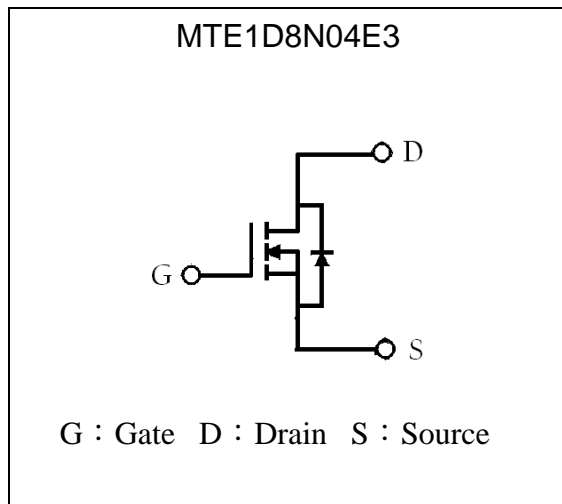

### Outline

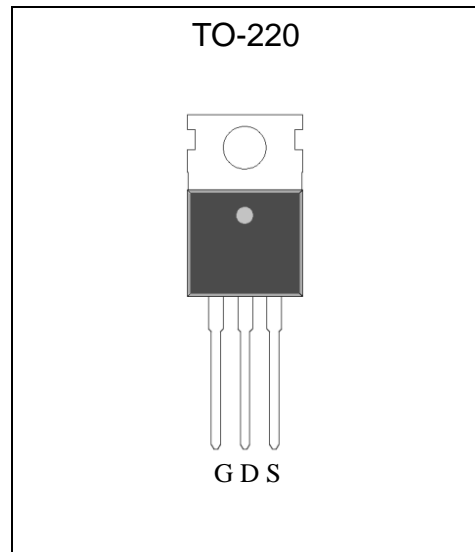

### Ordering Information

Device	Package	Shipping
MTE1D8N04E3-0-UB-X	TO-220 (Pb-free lead plating package)	50 pcs/tube, 20 tubes/box, 4 boxes / carton

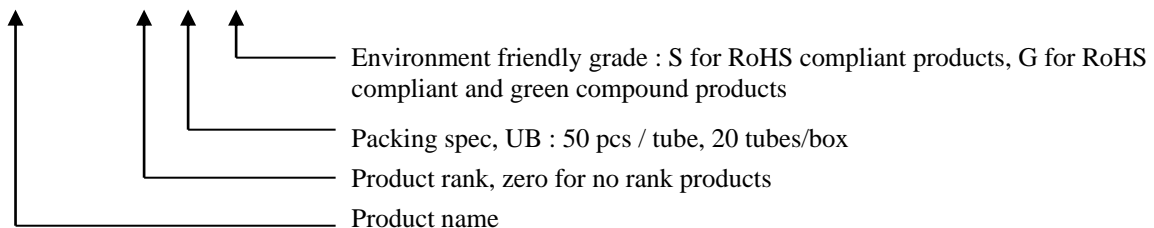

**Absolute Maximum Ratings** ( $T_C=25^\circ\text{C}$ )

Parameter	Symbol	Limits	Unit	
Drain-Source Voltage (Note 1)	$V_{DS}$	40	V	
Gate-Source Voltage	$V_{GS}$	$\pm 20$		
Continuous Drain Current @ $T_C=25^\circ\text{C}$ , $V_{GS}=10\text{V}$ (Note 1)	$I_D$	180	A	
Continuous Drain Current @ $T_C=100^\circ\text{C}$ , $V_{GS}=10\text{V}$ (Note 1)		127.3		
Continuous Drain Current @ $T_A=25^\circ\text{C}$ , $V_{GS}=10\text{V}$ (Note 2)	$I_{DSM}$	20		
Continuous Drain Current @ $T_A=70^\circ\text{C}$ , $V_{GS}=10\text{V}$ (Note 2)		16		
Pulsed Drain Current	$I_{DM}$	526		
Avalanche Current @ $L=0.1\text{mH}$	$I_{AS}$	100		
Single Pulse Avalanche Energy @ $L=1\text{mH}$ , $I_D=48\text{Amps}$ , $V_{DD}=25\text{V}$ (Note 4)	$E_{AS}$	1152	mJ	
Repetitive Avalanche Energy (Note 3)	$E_{AR}$	18	W	
Power Dissipation	$T_C=25^\circ\text{C}$ (Note 1)	$P_D$		188
	$T_C=100^\circ\text{C}$ (Note 1)	$P_D$		94
	$T_A=25^\circ\text{C}$ (Note 2)	$P_{DSM}$		2
	$T_A=70^\circ\text{C}$ (Note 2)		1.3	
Maximum Temperature for Soldering @ Lead at 0.063 in (1.6mm) from case for 10 seconds	$T_L$	300	$^\circ\text{C}$	
Maximum Temperature for Soldering @ Package Body for 10 seconds	$T_{PKG}$	260		
Operating Junction and Storage Temperature	$T_j, T_{stg}$	-55~+175		

\*Drain current limited by maximum junction temperature

**Thermal Data**

Parameter	Symbol	Value	Unit
Thermal Resistance, Junction-to-case, max	$R_{\theta JC}$	0.8	$^\circ\text{C/W}$
Thermal Resistance, Junction-to-ambient, max (Note 2)	$R_{\theta JA}$	62.5	

- Note :
1. The power dissipation  $P_D$  is based on  $T_{J(MAX)}=175^\circ\text{C}$ , using junction-to-case thermal resistance, and is more useful in setting the upper dissipation limit for cases where additional heatsinking is used.
  2. The value of  $R_{\theta JA}$  is measured with the device mounted on 1 in<sup>2</sup> FR-4 board with 2 oz. copper, in a still air environment with  $T_A=25^\circ\text{C}$ . The power dissipation  $P_{DSM}$  is based on  $R_{\theta JA}$  and the maximum allowed junction temperature of  $150^\circ\text{C}$ . The value in any given application depends on the user's specific board design, and the maximum temperature of  $175^\circ\text{C}$  may be used if the PCB allows it.
  3. Repetitive rating, pulse width limited by junction temperature  $T_{J(MAX)}=175^\circ\text{C}$ . Ratings are based on low frequency and low duty cycles to keep initial  $T_J=25^\circ\text{C}$ .
  4. 100% tested by condition of  $V_{DD}=25\text{V}$ ,  $I_D=50\text{A}$ ,  $L=0.1\text{mH}$ ,  $V_{GS}=10\text{V}$ .
  5. The static characteristics are obtained using  $<300\mu\text{s}$  pulses, duty cycle 0.5% maximum.
  6. The  $R_{\theta JA}$  is the sum of thermal resistance from junction to case  $R_{\theta JC}$  and case to ambient



**Characteristics (Tj=25°C, unless otherwise specified)**

Symbol	Min.	Typ.	Max.	Unit	Test Conditions
<b>Static</b>					
BV <sub>DSS</sub>	40	-	-	V	V <sub>GS</sub> =0V, I <sub>D</sub> =250μA
ΔBV <sub>DSS</sub> /ΔT <sub>j</sub>	-	30	-	mV/°C	Reference to 25°C, I <sub>D</sub> =250μA
V <sub>GS(th)</sub>	2	-	4	V	V <sub>DS</sub> = V <sub>GS</sub> , I <sub>D</sub> =250μA
*G <sub>FS</sub>	-	49.4	-	S	V <sub>DS</sub> =5V, I <sub>D</sub> =20A
I <sub>GSS</sub>	-	-	±100	nA	V <sub>GS</sub> =±20V, V <sub>DS</sub> =0V
I <sub>DSS</sub>	-	-	1	μA	V <sub>DS</sub> =32V, V <sub>GS</sub> =0V
	-	-	25		V <sub>DS</sub> =32V, V <sub>GS</sub> =0V, T <sub>j</sub> =125°C
*R <sub>DS(ON)</sub>	-	1.8	2.6	mΩ	V <sub>GS</sub> =10V, I <sub>D</sub> =50A
<b>Dynamic</b>					
*Q <sub>g</sub>	-	118.2	-	nC	V <sub>DD</sub> =20V, I <sub>D</sub> =50A, V <sub>GS</sub> =10V
*Q <sub>gs</sub>	-	30	-		
*Q <sub>gd</sub>	-	34.3	-		
*t <sub>d(ON)</sub>	-	39.4	-	ns	V <sub>DD</sub> =20V, I <sub>D</sub> =50A, V <sub>GS</sub> =10V, R <sub>G</sub> =1Ω
*t <sub>r</sub>	-	26.4	-		
*t <sub>d(OFF)</sub>	-	74.8	-		
*t <sub>f</sub>	-	20.2	-		
C <sub>iss</sub>	-	6020	-	pF	V <sub>GS</sub> =0V, V <sub>DS</sub> =30V, f=1MHz
C <sub>oss</sub>	-	802	-		
C <sub>rss</sub>	-	364	-		
R <sub>g</sub>	-	0.6	-	Ω	f=1MHz
<b>Source-Drain Diode</b>					
*I <sub>S</sub>	-	-	180	A	
*I <sub>SM</sub>	-	-	526		
*V <sub>SD</sub>	-	0.79	1.2	V	I <sub>S</sub> =30A, V <sub>GS</sub> =0V
*t <sub>rr</sub>	-	30.3	-	ns	V <sub>GS</sub> =0V, I <sub>F</sub> =50A, dI <sub>F</sub> /dt=100A/μs
*Q <sub>rr</sub>	-	24.7	-	nC	

\*Pulse Test : Pulse Width ≤300μs, Duty Cycle≤2%

**Typical Characteristics**

Typical Output Characteristics

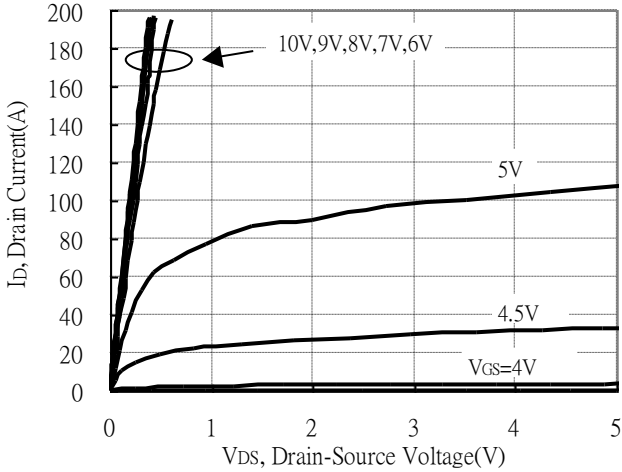

Brekdown Voltage vs Junction Temperature

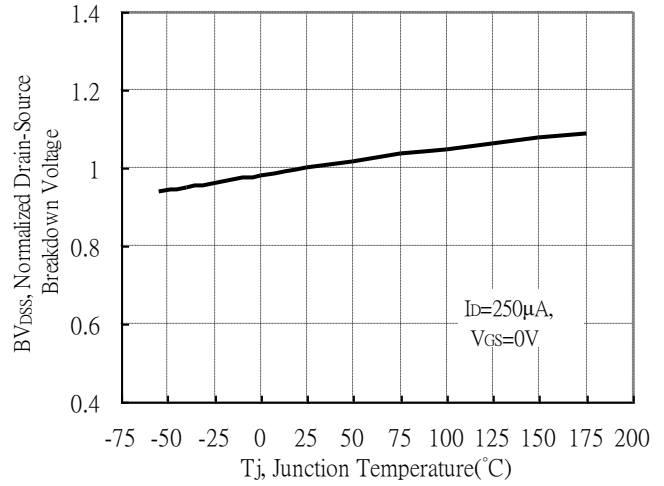

Static Drain-Source On-State resistance vs Drain Current

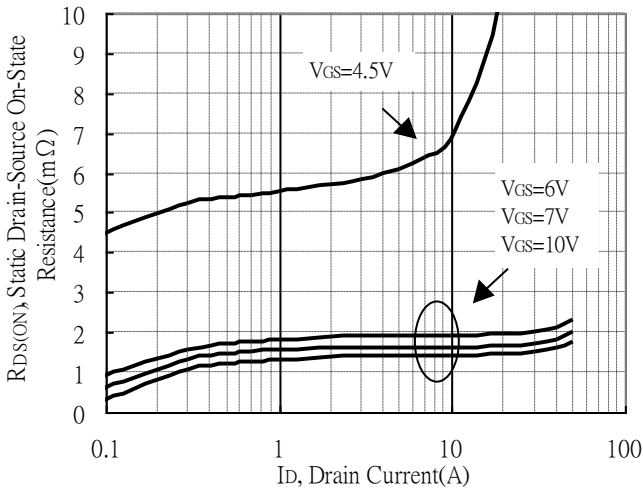

Reverse Drain Current vs Source-Drain Voltage

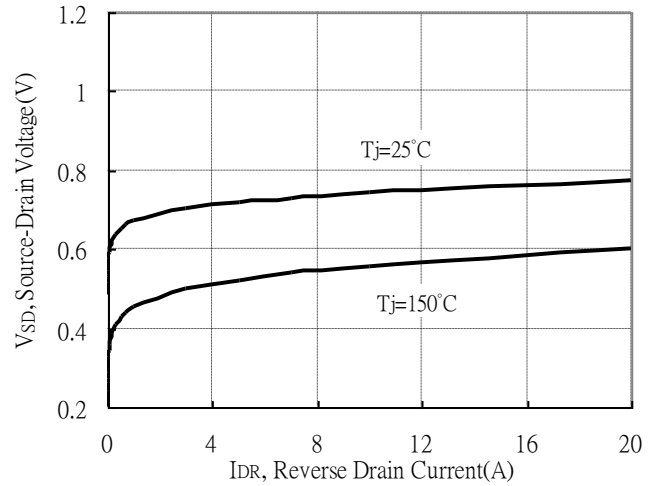

Static Drain-Source On-State Resistance vs Gate-Source Voltage

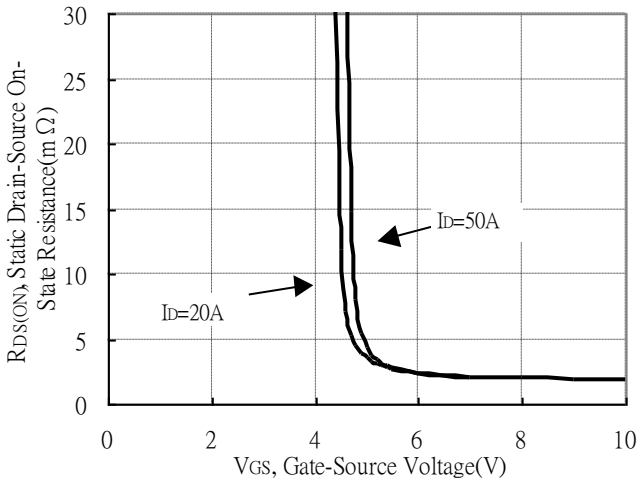

Drain-Source On-State Resistance vs Junction Temperature

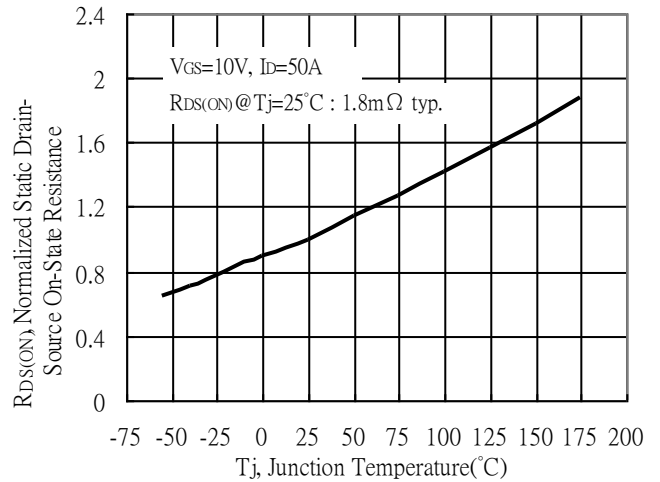



Typical Characteristics(Cont.)

Capacitance vs Drain-to-Source Voltage

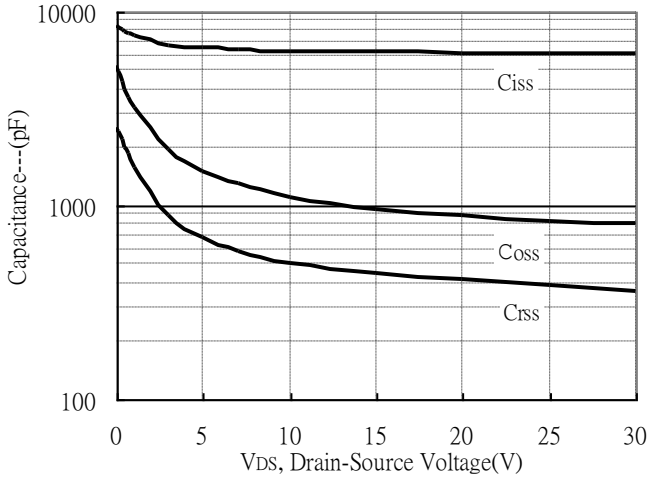

Threshold Voltage vs Junction Temperature

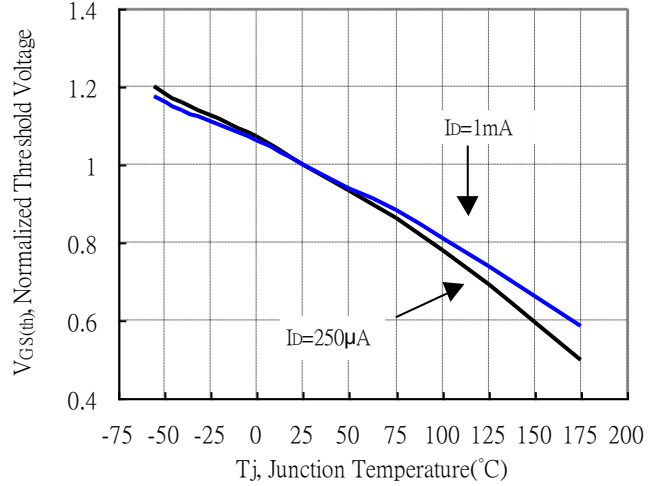

Forward Transfer Admittance vs Drain Current

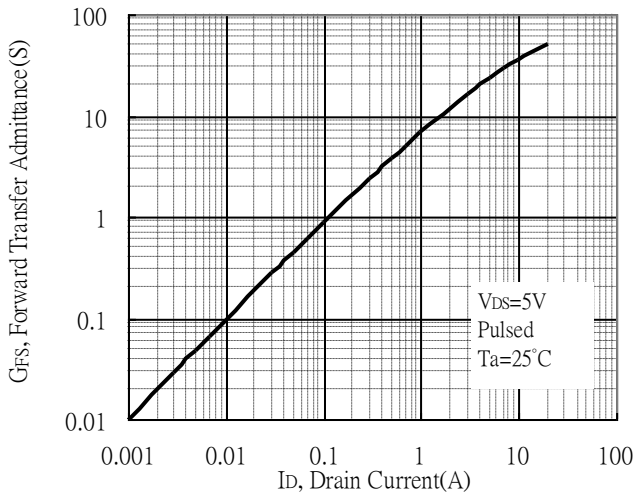

Gate Charge Characteristics

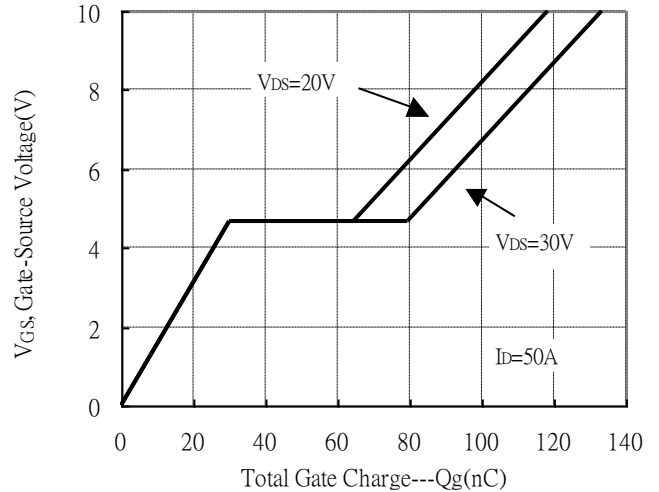

Maximum Safe Operating Area

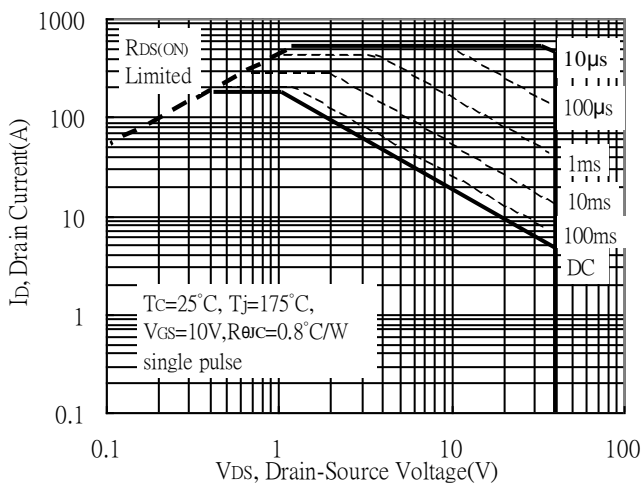

Maximum Drain Current vs Case Temperature

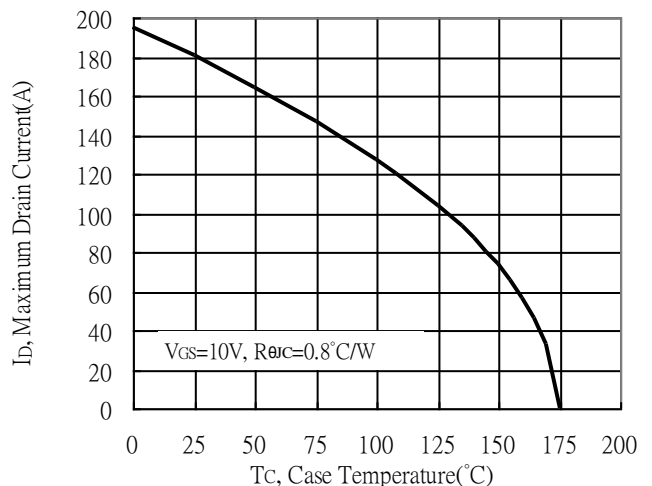



### Typical Characteristics(Cont.)

Typical Transfer Characteristics

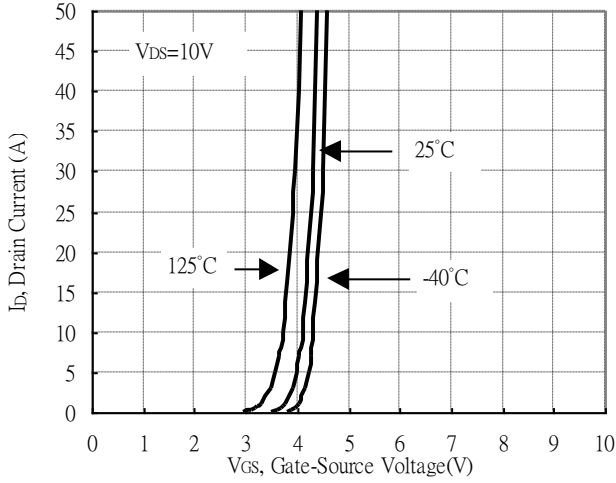

Single Pulse Maximum Power Dissipation

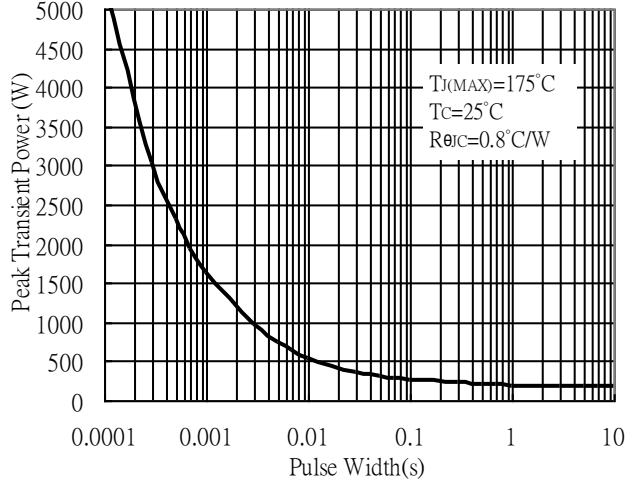

Transient Thermal Response Curves

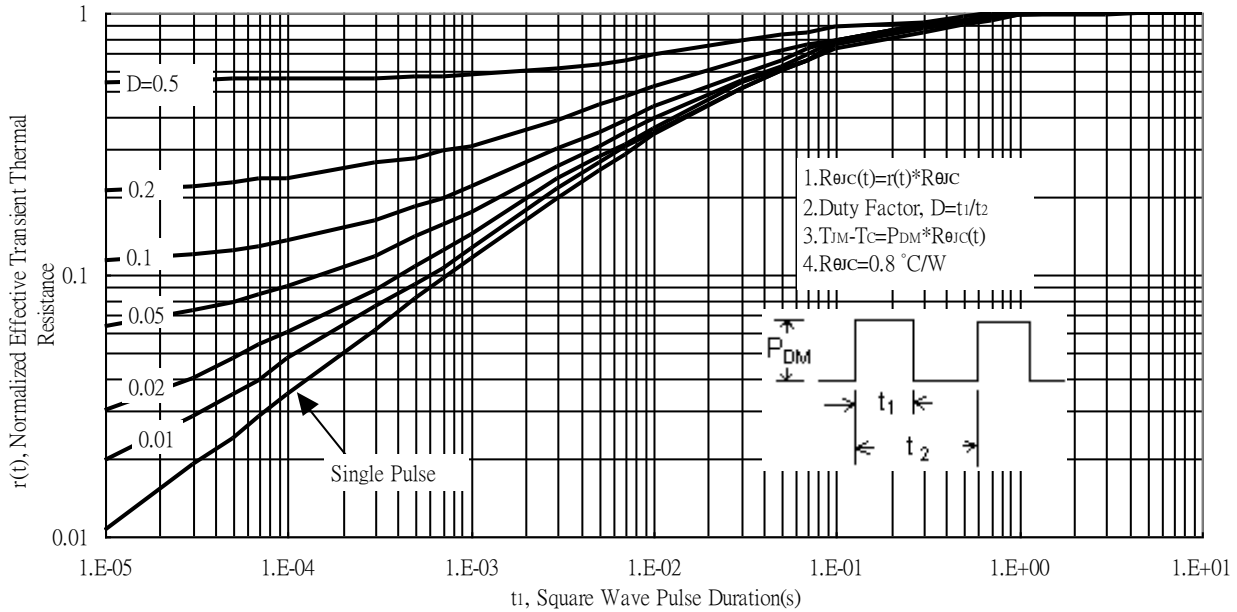

**Recommended wave soldering condition**

Product	Peak Temperature	Soldering Time
Pb-free devices	260 +0/-5 °C	5 +1/-1 seconds

**Recommended temperature profile for IR reflow**

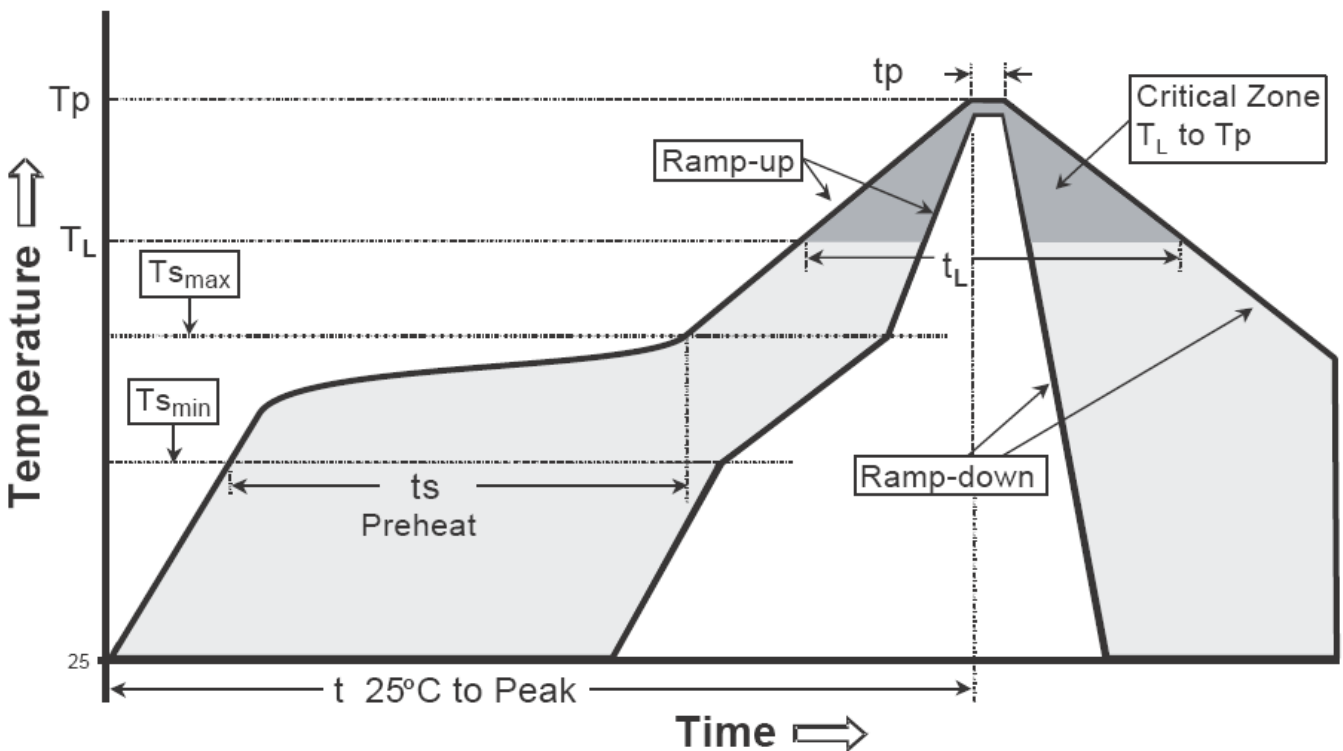

Profile feature	Sn-Pb eutectic Assembly	Pb-free Assembly
Average ramp-up rate (T <sub>smax</sub> to T <sub>p</sub> )	3°C/second max.	3°C/second max.
Preheat		
-Temperature Min(T <sub>s min</sub> )	100°C	150°C
-Temperature Max(T <sub>s max</sub> )	150°C	200°C
-Time(t <sub>s min</sub> to t <sub>s max</sub> )	60-120 seconds	60-180 seconds
Time maintained above:		
-Temperature (T <sub>L</sub> )	183°C	217°C
- Time (t <sub>L</sub> )	60-150 seconds	60-150 seconds
Peak Temperature(T <sub>p</sub> )	240 +0/-5 °C	260 +0/-5 °C
Time within 5°C of actual peak temperature(tp)	10-30 seconds	20-40 seconds
Ramp down rate	6°C/second max.	6°C/second max.
Time 25 °C to peak temperature	6 minutes max.	8 minutes max.

Note : All temperatures refer to topside of the package, measured on the package body surface.

**TO-220 Dimension**

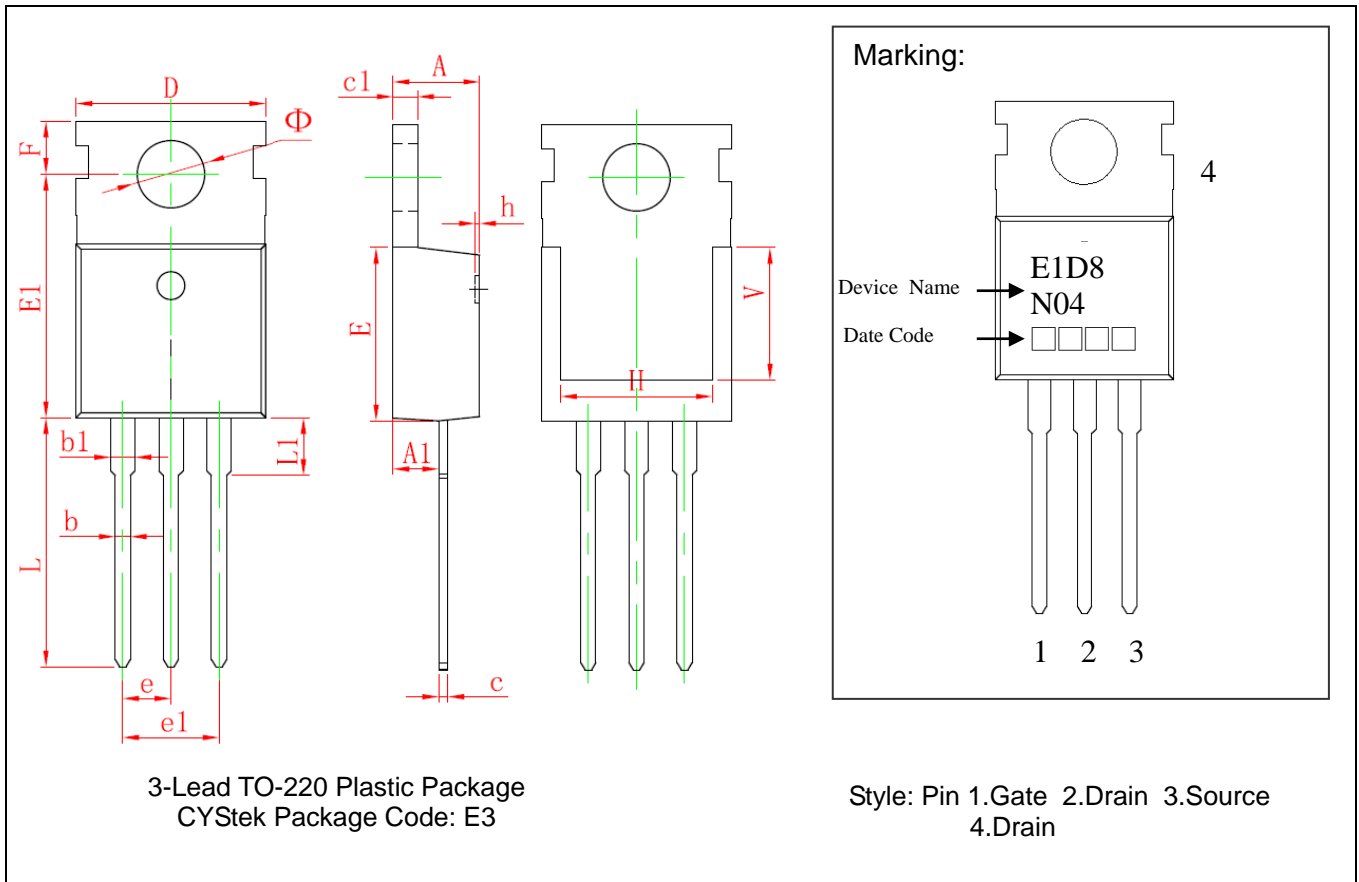

\*: Typical

DIM	Millimeters		Inches		DIM	Millimeters		Inches	
	Min.	Max.	Min.	Max.		Min.	Max.	Min.	Max.
A	4.400	4.600	0.173	0.181	e	2.540*		0.100*	
A1	2.250	2.550	0.089	0.100	e1	4.980	5.180	0.196	0.204
b	0.710	0.910	0.028	0.036	F	2.650	2.950	0.104	0.116
b1	1.170	1.370	0.046	0.054	H	7.900	8.100	0.311	0.319
c	0.330	0.650	0.013	0.026	h	0.000	0.300	0.000	0.012
c1	1.200	1.400	0.047	0.055	L	12.900	13.400	0.508	0.528
D	9.910	10.250	0.390	0.404	L1	2.850	3.250	0.112	0.128
E	8.950	9.750	0.352	0.384	V	7.500	REF	0.295	REF
E1	12.650	12.950	0.498	0.510	Φ	3.600	3.800	0.142	0.150

Notes: 1.Controlling dimension: millimeters.  
 2.Maximum lead thickness includes lead finish thickness, and minimum lead thickness is the minimum thickness of base material.  
 3.If there is any question with packing specification or packing method, please contact your local CYStek sales office.

**Material:**

- Lead: Pure tin plated.
- Mold Compound: Epoxy resin family, flammability solid burning class: UL94V-0.

**Important Notice:**

- All rights are reserved. Reproduction in whole or in part is prohibited without the prior written approval of CYStek.
- CYStek reserves the right to make changes to its products without notice.
- CYStek **semiconductor products are not warranted to be suitable for use in Life-Support Applications, or systems.**
- CYStek assumes no liability for any consequence of customer product design, infringement of patents, or application assistance.