

N-Channel Enhancement Mode Power MOSFET

MTE05N08F3

BV_{DSS}	80V
$I_D @ T_C=25^{\circ}C, V_{GS}=10V$	180A
$R_{DSON(TYP)} @ V_{GS}=10V, I_D=20A$	3.6m Ω
$R_{DSON(TYP)} @ V_{GS}=7V, I_D=20A$	4.0m Ω

Features

- Low Gate Charge
- Simple Drive Requirement
- Repetitive Avalanche Rated
- Fast Switching Characteristic
- RoHS compliant package

Symbol

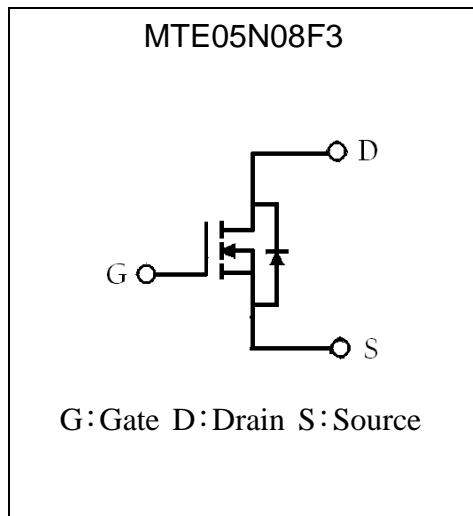

Outline

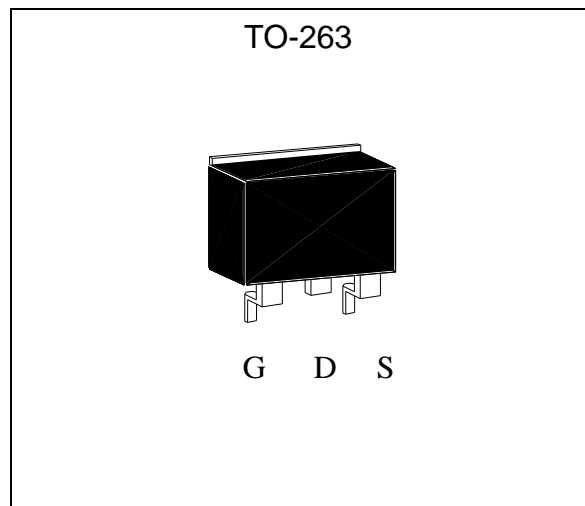

Ordering Information

Device	Package	Shipping
MTE05N08F3-0-T7-X	TO-263 RoHS compliant package)	800 pcs / Tape & Reel

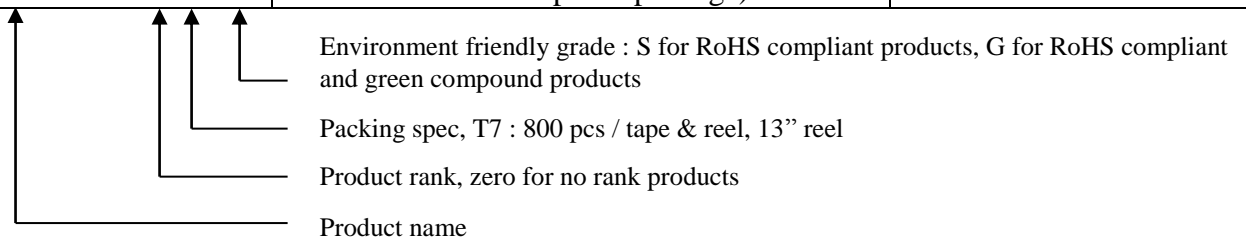

**Absolute Maximum Ratings** ($T_C=25^{\circ}\text{C}$, unless otherwise noted)

Parameter	Symbol	Limits	Unit	
Drain-Source Voltage	V_{DS}	80	V	
Gate-Source Voltage	V_{GS}	± 25		
Continuous Drain Current @ $T_C=25^{\circ}\text{C}$, $V_{GS}=10\text{V}$ (Note 1)	I_D	180	A	
Continuous Drain Current @ $T_C=100^{\circ}\text{C}$, $V_{GS}=10\text{V}$ (Note 1)		127		
Pulsed Drain Current (Note 3)	I_{DM}	500		
Continuous Drain Current @ $T_A=25^{\circ}\text{C}$, $V_{GS}=10\text{V}$ (Note 2)	I_{DSM}	14		
Continuous Drain Current @ $T_A=70^{\circ}\text{C}$, $V_{GS}=10\text{V}$ (Note 2)		11		
Avalanche Current @ $L=0.1\text{mH}$ (Note 3)	I_{AS}	120		
Avalanche Energy @ $L=0.1\text{mH}$, $I_D=90\text{A}$, $R_G=25\ \Omega$ (Note 2)	E_{AS}	405	mJ	
Repetitive Avalanche Energy @ $L=0.1\text{mH}$ (Note 3)	E_{AR}	33		
Power Dissipation	P_D	$T_C=25^{\circ}\text{C}$ (Note 1)	333	W
		$T_C=100^{\circ}\text{C}$ (Note 1)	167	
Power Dissipation	P_{DSM}	$T_A=25^{\circ}\text{C}$ (Note 2)	2	W
		$T_A=70^{\circ}\text{C}$ (Note 2)	1.3	
Operating Junction and Storage Temperature	T_j, T_{stg}	-55~+175	$^{\circ}\text{C}$	

Thermal Data

Parameter	Symbol	Value	Unit
Thermal Resistance, Junction-to-case, max	$R_{th,j-c}$	0.45	$^{\circ}\text{C}/\text{W}$
Thermal Resistance, Junction-to-ambient, max, $t \leq 10\text{s}$ (Note 1)	$R_{th,j-a}$	15	
Thermal Resistance, Junction-to-ambient, max (Note 1)		62.5	

- Note : 1. The power dissipation P_D is based on $T_{J(MAX)}=175^{\circ}\text{C}$, using junction-to-case thermal resistance, and is more useful in setting the upper dissipation limit for cases where additional heatsinking is used.
2. The value of $R_{\theta JA}$ is measured with the device mounted on 1 in² FR-4 board with 2 oz. copper, in a still air environment with $T_A=25^{\circ}\text{C}$. The power dissipation P_{DSM} is based on $R_{\theta JA}$ and the maximum allowed junction temperature of 150°C . The value in any given application depends on the user's specific board design, and the maximum temperature of 175°C may be used if the PCB allows it.
3. Repetitive rating, pulse width limited by junction temperature $T_{J(MAX)}=175^{\circ}\text{C}$. Ratings are based on low frequency and low duty cycles to keep initial $T_J=25^{\circ}\text{C}$.
4. The maximum current limited by package is 120A.
5. The static characteristics are obtained using $<300\ \mu\text{s}$ pulses, duty cycle 0.5% maximum.
6. The $R_{\theta JA}$ is the sum of thermal resistance from junction to case $R_{\theta JC}$ and case to ambient.



Characteristics (Tc=25°C, unless otherwise specified)

Symbol	Min.	Typ.	Max.	Unit	Test Conditions
Static					
BV _{DSS}	80	-	-	V	V _{GS} =0V, I _D =250μA
V _{GS(th)}	2.0	-	4.0		V _{DS} = V _{GS} , I _D =250μA
G _{FS}	-	57	-	S	V _{DS} =5V, I _D =20A
I _{GSS}	-	-	±100	nA	V _{GS} =±25V, V _{DS} =0V
I _{DSS}	-	-	10	μA	V _{DS} =80V, V _{GS} =0V
	-	-	50		V _{DS} =80V, V _{GS} =0V, T _j =55°C
*R _{DS(ON)}	-	3.6	5.2	mΩ	V _{GS} =10V, I _D =20A
	-	4.0	5.5		V _{GS} =7V, I _D =20A
Dynamic					
*Q _g	-	122.5	-	nC	I _D =20A, V _{DS} =40V, V _{GS} =10V
*Q _{gs}	-	20	-		
*Q _{gd}	-	42.8	-		
*t _{d(ON)}	-	40	-	ns	V _{DS} =40V, I _D =20A, V _{GS} =10V, R _G =3Ω
*t _r	-	40.8	-		
*t _{d(OFF)}	-	94.4	-		
*t _f	-	30.2	-		
C _{iss}	-	6220	-	pF	V _{GS} =0V, V _{DS} =40V, f=1MHz
C _{oss}	-	723	-		
C _{rss}	-	240	-		
R _g	-	1	-	Ω	f=1MHz
Source-Drain Diode					
*I _S	-	-	180	A	
*V _{SD}	-	0.66	1	V	I _S =1A, V _{GS} =0V
*t _{rr}	-	42	-	ns	I _F =20A, V _{GS} =0V, dI _F /dt=100A/μs
*Q _{rr}	-	69	-	nC	

*Pulse Test : Pulse Width ≤300μs, Duty Cycle≤2%

Typical Characteristics

Typical Output Characteristics

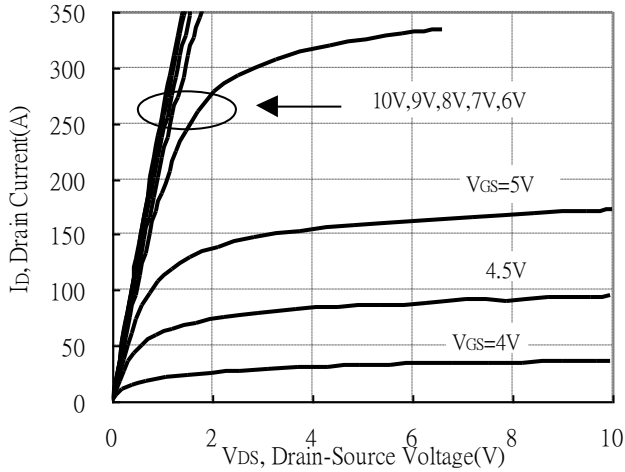

Brekdown Voltage vs Junction Temperature

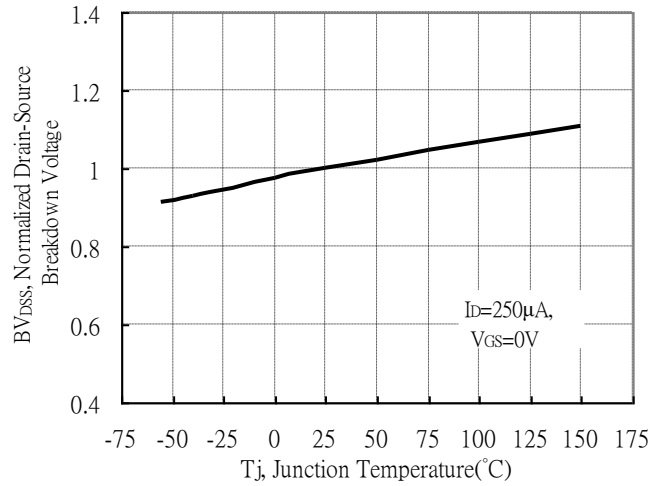

Static Drain-Source On-State resistance vs Drain Current

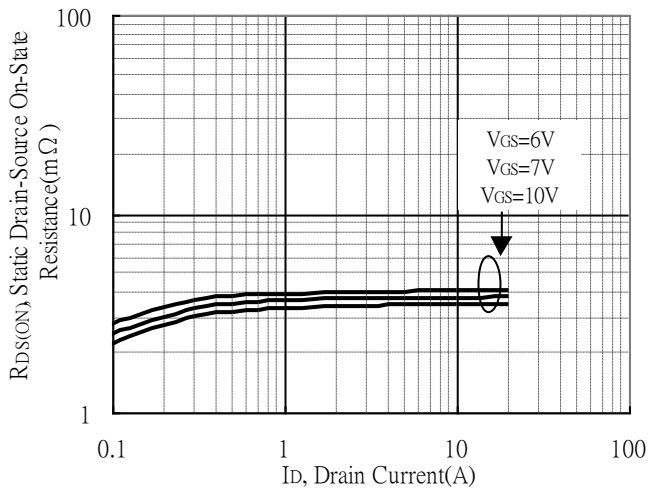

Reverse Drain Current vs Source-Drain Voltage

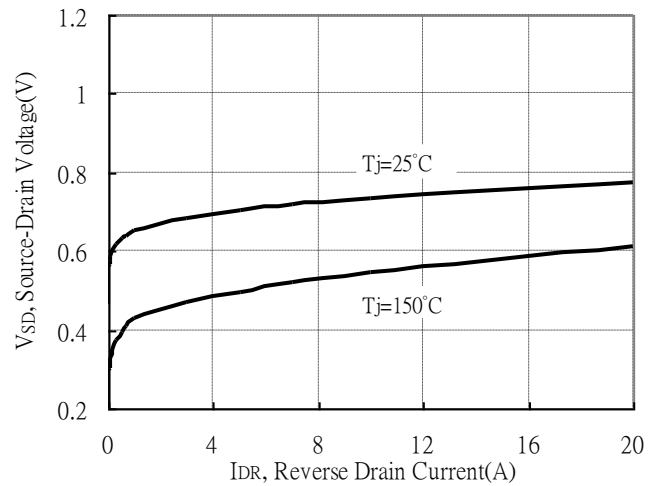

Static Drain-Source On-State Resistance vs Gate-Source Voltage

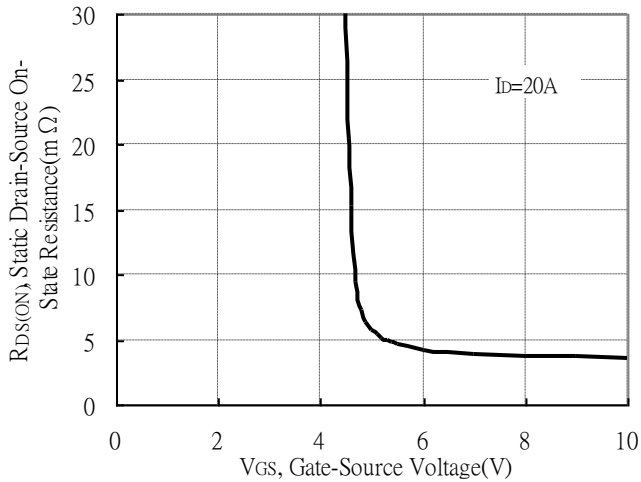

Drain-Source On-State Resistance vs Junction Temperature

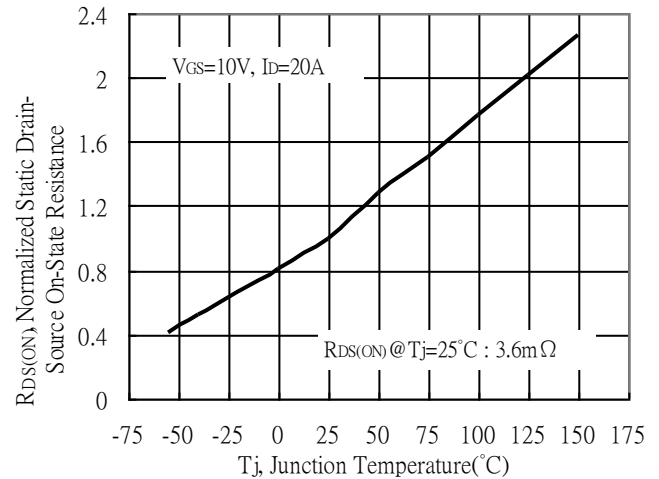

Typical Characteristics(Cont.)

Capacitance vs Drain-to-Source Voltage

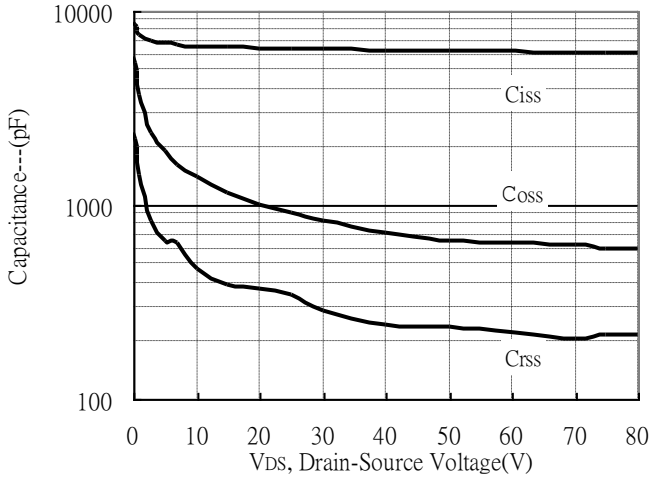

Threshold Voltage vs Junction Temperature

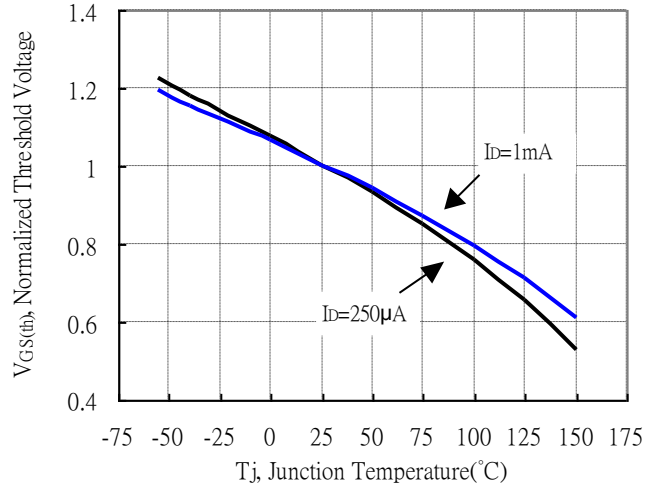

Forward Transfer Admittance vs Drain Current

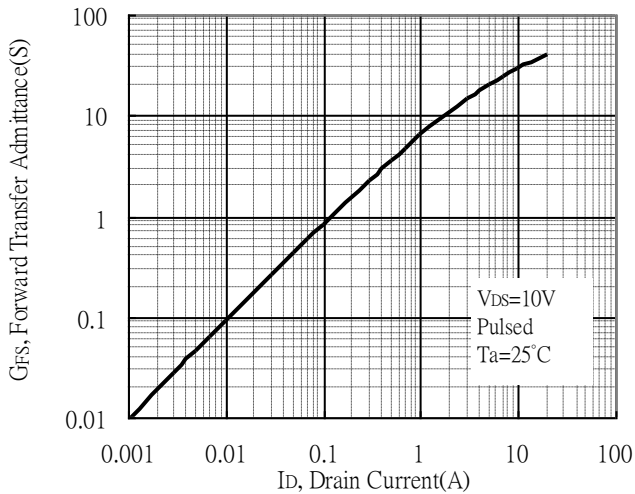

Gate Charge Characteristics

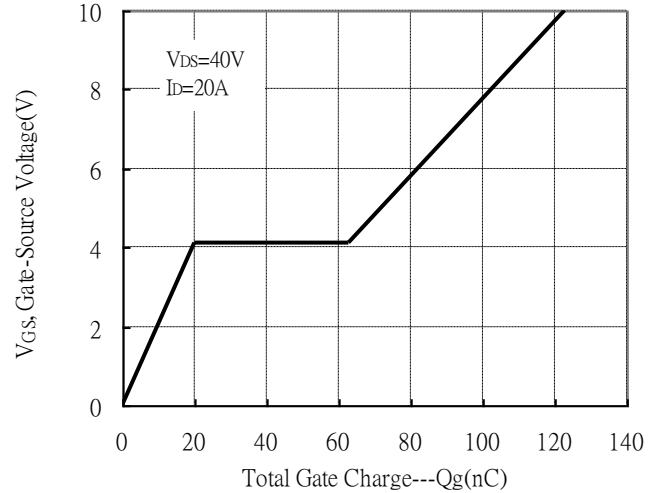

Maximum Safe Operating Area

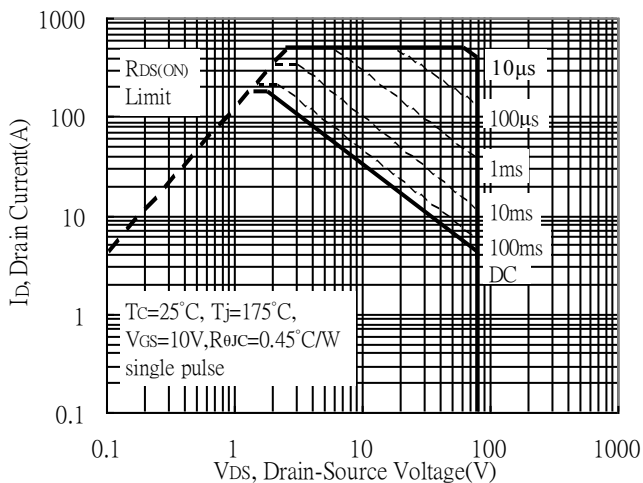

Maximum Drain Current vs Case Temperature

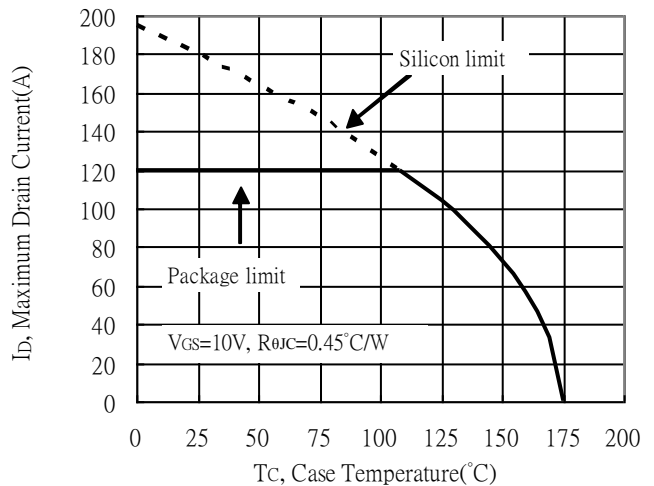

Typical Characteristics(Cont.)

Typical Transfer Characteristics

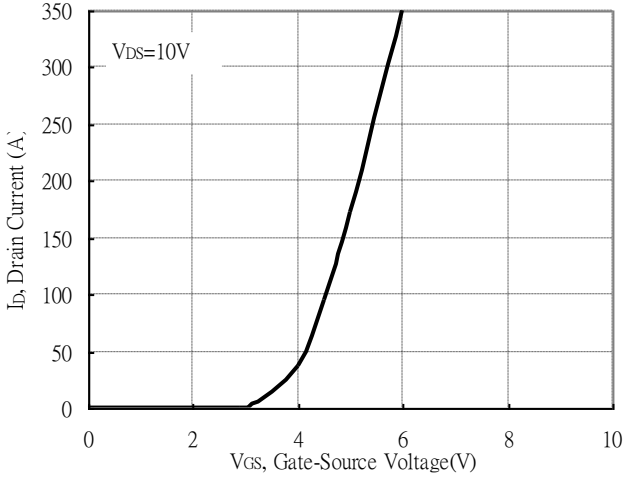

Single Pulse Maximum Power Dissipation

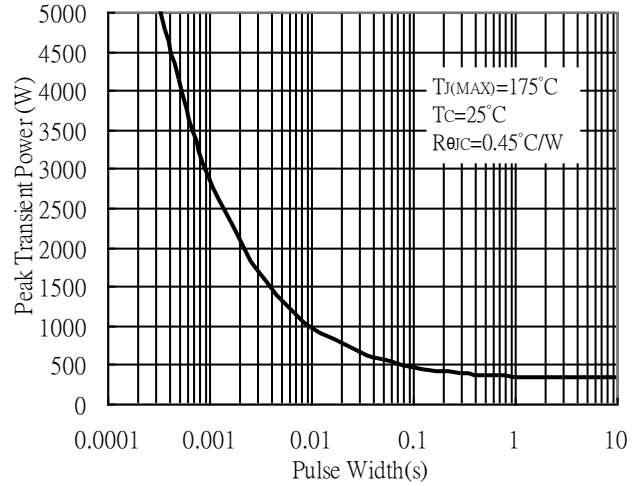

Transient Thermal Response Curves

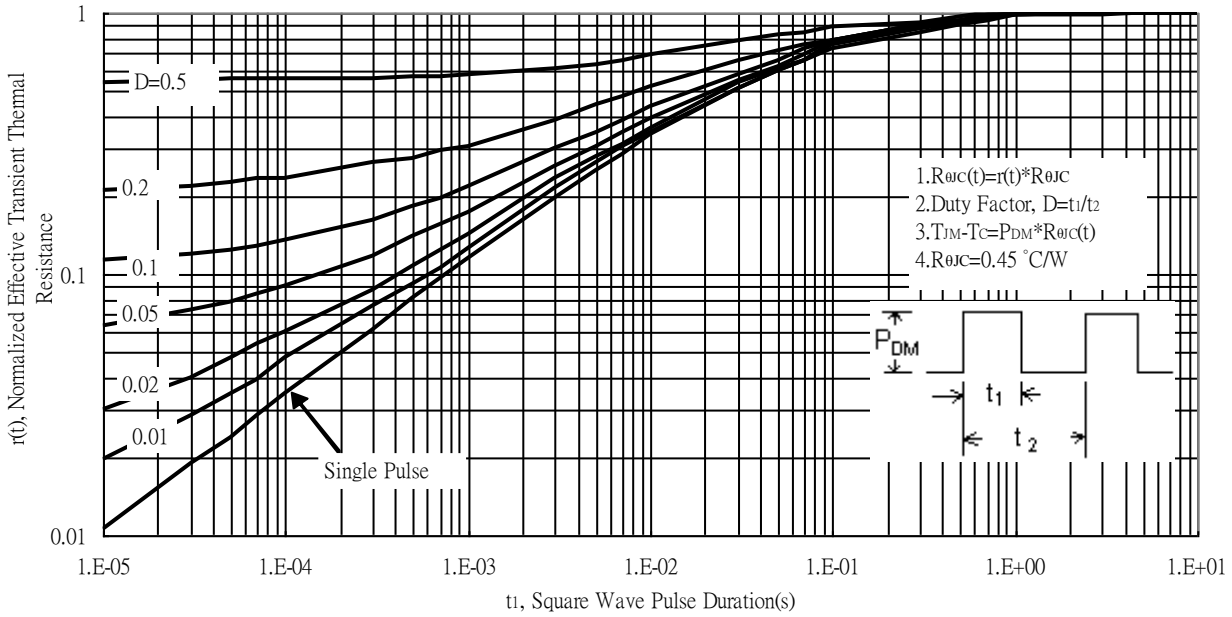

Reel Dimension

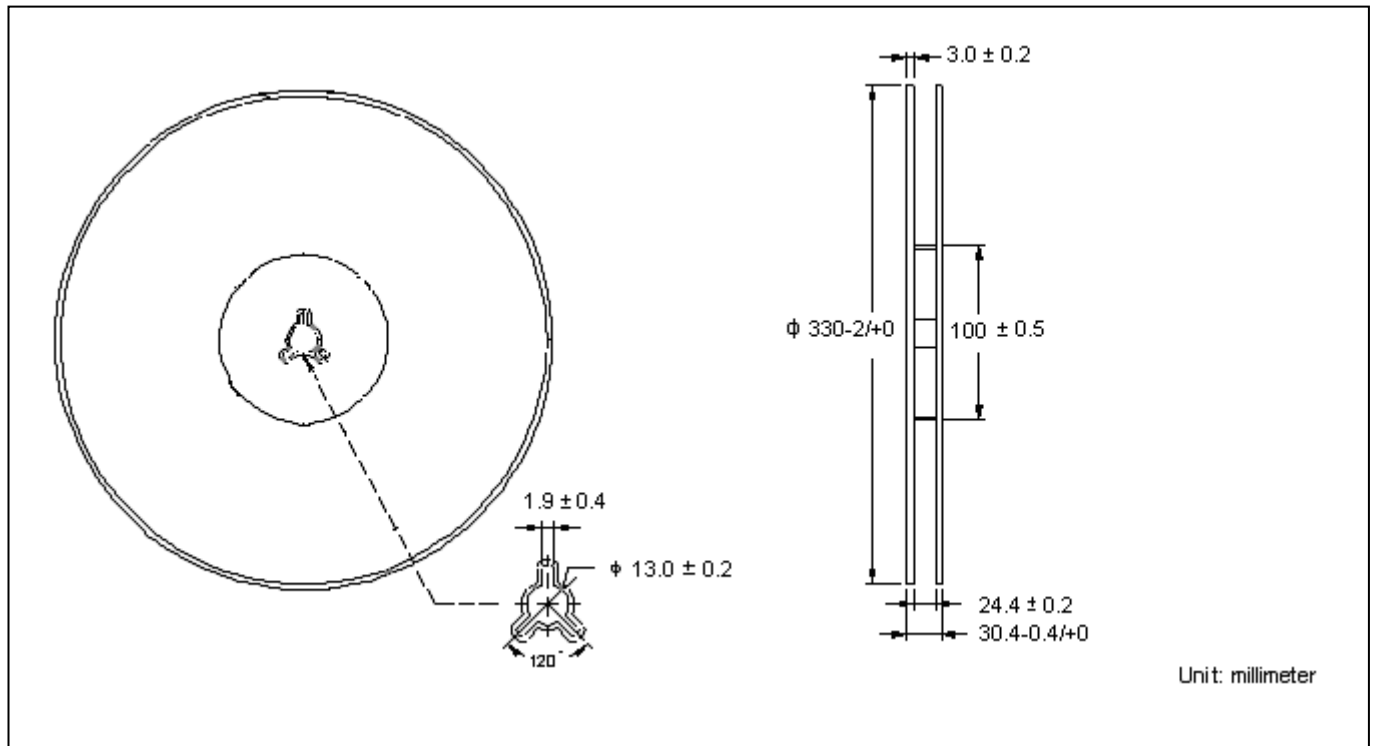

Carrier Tape Dimension

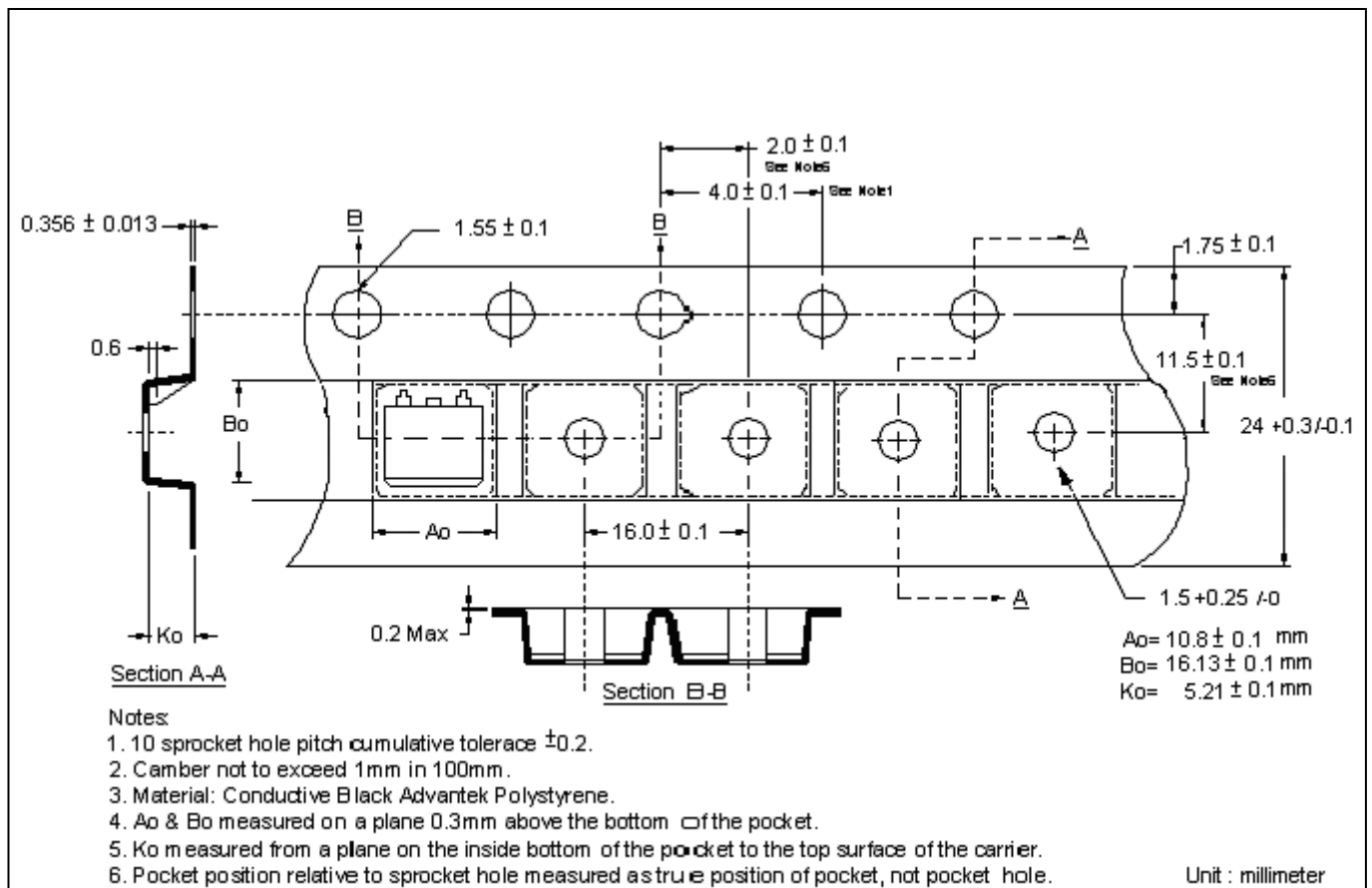

Recommended wave soldering condition

Product	Peak Temperature	Soldering Time
Pb-free devices	260 +0/-5 °C	5 +1/-1 seconds

Recommended temperature profile for IR reflow

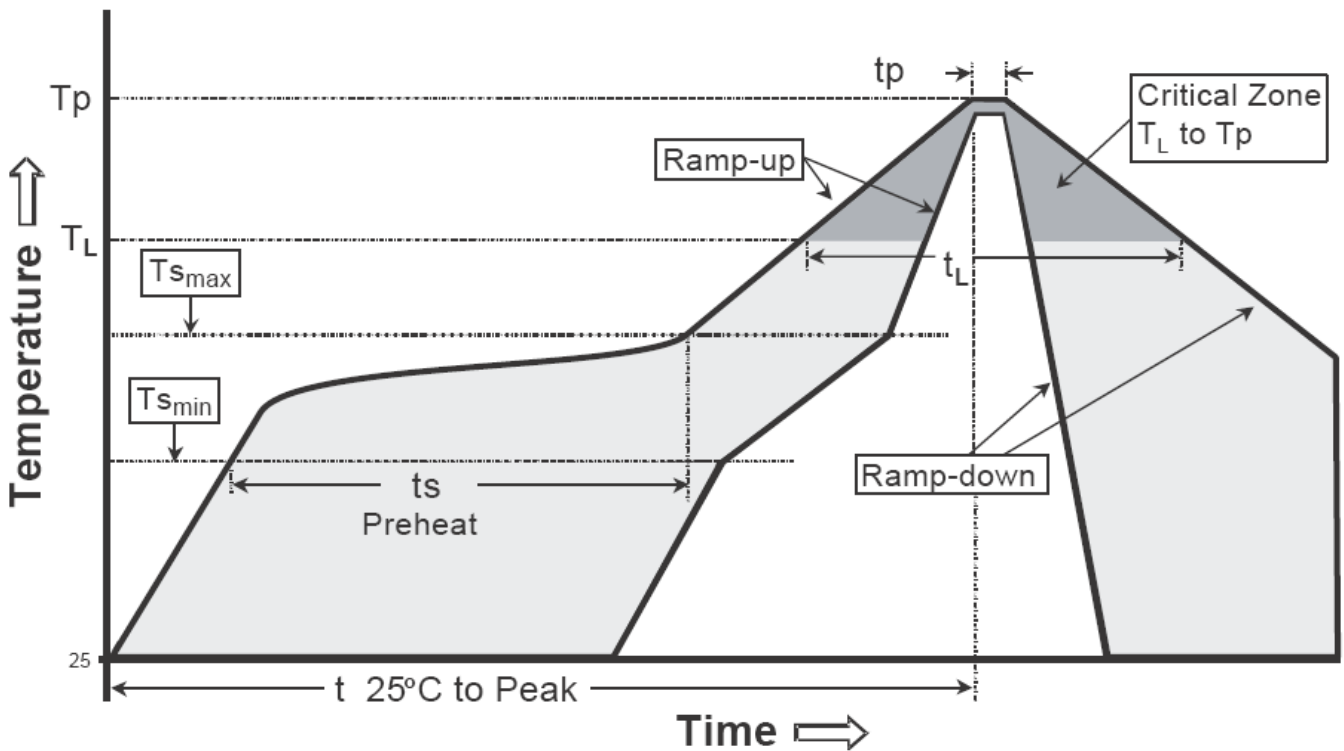

Profile feature	Sn-Pb eutectic Assembly	Pb-free Assembly
Average ramp-up rate (T_{smax} to T_p)	3°C/second max.	3°C/second max.
Preheat		
-Temperature Min($T_{s min}$)	100°C	150°C
-Temperature Max($T_{s max}$)	150°C	200°C
-Time($t_{s min}$ to $t_{s max}$)	60-120 seconds	60-180 seconds
Time maintained above:		
-Temperature (T_L)	183°C	217°C
- Time (t_L)	60-150 seconds	60-150 seconds
Peak Temperature(T_P)	240 +0/-5 °C	260 +0/-5 °C
Time within 5°C of actual peak temperature(t_p)	10-30 seconds	20-40 seconds
Ramp down rate	6°C/second max.	6°C/second max.
Time 25 °C to peak temperature	6 minutes max.	8 minutes max.

Note : All temperatures refer to topside of the package, measured on the package body surface.

TO-263 Dimension

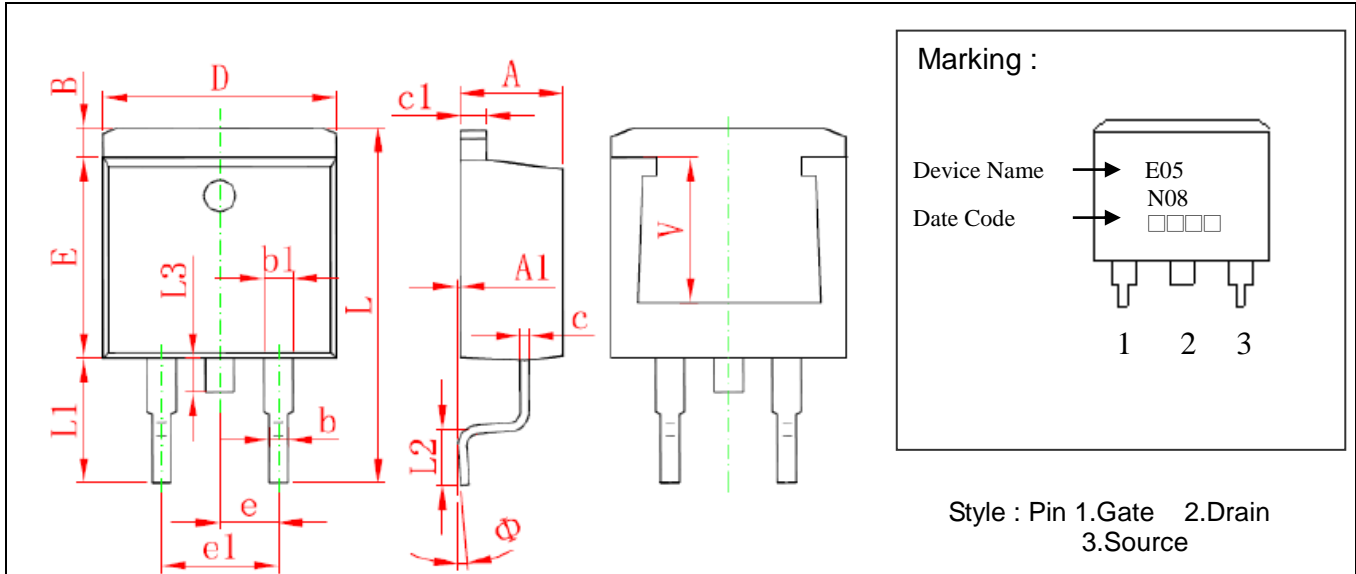

Marking :

Device Name → E05
 Date Code → N08 □□□□

Style : Pin 1.Gate 2.Drain 3.Source

**3-Lead Plastic Surface Mounted Package
 CYStek Package Code : F3**

Date Code : (From left to right)
 First Code : Year code, the last digit of Christnr year. For example, 2014→4, 2015→, 2016→6, ..., etc.
 Second Code : Month code, Jan→A, Feb→B, Mar→C, Apr→D, May→E, Jun→F, Jul→G, Aug→H, Sep→J,
 Oct→K, Nov→L, Dec→M
 Third and fourth codes : production serial number, 01~99

DIM	Millimeters		Inches		DIM	Millimeters		Inches	
	Min.	Max.	Min.	Max.		Min.	Max.	Min.	Max.
A	4.470	4.670	0.176	0.184	e	2.540 TYP		0.100 TYP	
A1	0.000	0.150	0.000	0.006	e1	4.980	5.180	0.196	0.204
B	1.120	1.420	0.044	0.056	L	14.940	15.500	0.588	0.610
b	0.710	0.910	0.028	0.036	L1	4.950	5.450	0.195	0.215
b1	1.170	1.370	0.046	0.054	L2	2.340	2.740	0.092	0.108
c	0.310	0.530	0.012	0.021	L3	1.300	1.700	0.051	0.067
c1	1.170	1.370	0.046	0.054	Φ	0°	8°	0°	8°
D	10.010	10.310	0.394	0.406	V	6.400 REF		0.253 REF	
E	8.500	8.900	0.335	0.350					

Notes : 1.Controlling dimension : millimeters.
 2.Maximum lead thickness includes lead finish thickness, and minimum lead thickness is the minimum thickness of base material.
 3.If there is any question with packing specification or packing method, please contact your local CYStek sales office.

Material :

- Lead : Pure tin plated.
- Mold Compound : Epoxy resin family, flammability solid burning class:UL94V-0.

Important Notice:

- All rights are reserved. Reproduction in whole or in part is prohibited without the prior written approval of CYStek.
- CYStek reserves the right to make changes to its products without notice.
- CYStek **semiconductor products are not warranted to be suitable for use in Life-Support Applications, or systems.**
- CYStek assumes no liability for any consequence of customer product design, infringement of patents, or application assistance.