

# N- AND P-Channel Enhancement Mode MOSFET

## MTE028C03DV8

	N-CH	P-CH
$BV_{DSS}$	30V	-30V
$I_D$ @ $T_A=25\text{ }^\circ\text{C}$ , $V_{GS}=10\text{V} (-10\text{V})$	5.4A	-4.3A
$R_{DSON}(\text{max.})$ @ $V_{GS}=(-)10\text{V}$	24m $\Omega$	43m $\Omega$

### Features

- Single Drive Requirement
- Low On-resistance
- Fast Switching Characteristic
- Pb-free lead plating and halogen-free package

### Equivalent Circuit

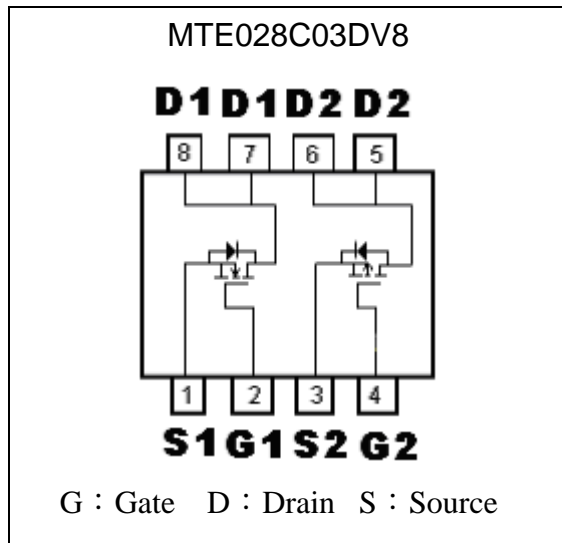

### Outline

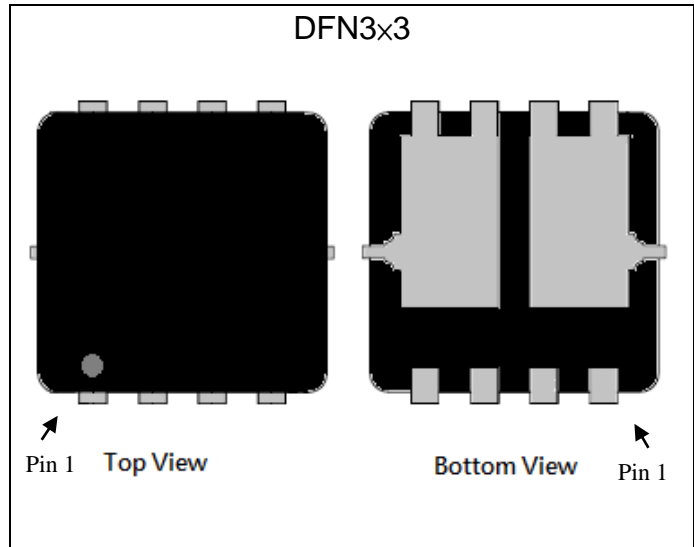

### Ordering Information

Device	Package	Shipping
MTE028C03DV8-0-T6-G	DFN3x3 (Pb-free lead plating and halogen-free package)	3000 pcs / Tape & Reel

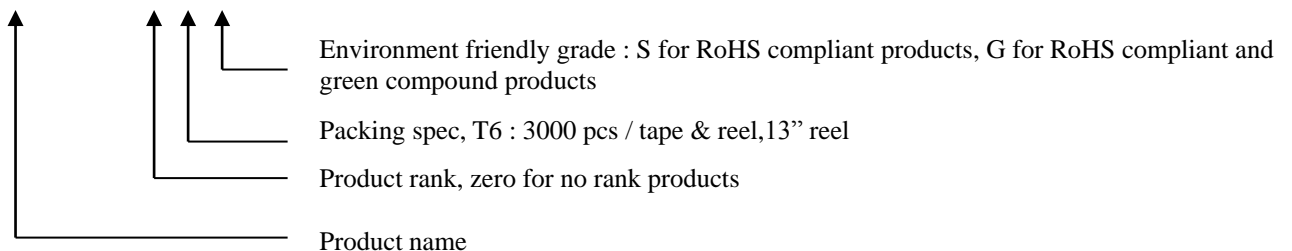



**Absolute Maximum Ratings** (Tc=25°C, unless otherwise noted)

Parameter		Symbol	Limits		Unit
			N-channel	P-channel	
Drain-Source Breakdown Voltage		BV <sub>DSS</sub>	30	-30	V
Gate-Source Voltage		V <sub>GS</sub>	±20	±20	
Continuous Drain Current *2	T <sub>A</sub> =25 °C, V <sub>GS</sub> =10V (-10V)	I <sub>DSM</sub>	5.4	-4.3	A
	T <sub>A</sub> =70 °C, V <sub>GS</sub> =10V (-10V)		4.3	-3.5	
Continuous Drain Current	T <sub>C</sub> =25 °C, V <sub>GS</sub> =10V (-10V)	I <sub>D</sub>	7.8	-6.3	
	T <sub>C</sub> =100 °C, V <sub>GS</sub> =10V (-10V)		4.9	-3.9	
Pulsed Drain Current *1		I <sub>DM</sub>	30	-25	
Total Power Dissipation	T <sub>A</sub> =25°C, Single device operation	P <sub>DSM</sub>	1.5 *2		W
	T <sub>A</sub> =70°C, Single device operation		0.96 *2		
	T <sub>A</sub> =25°C, Single device value at dual operation		1.24 *2		
	T <sub>A</sub> =70°C, Single device value at dual operation		0.79 *2		
	T <sub>C</sub> =25°C	P <sub>D</sub>	3.1		
	T <sub>C</sub> =100°C		1.2		
Operating Junction and Storage Temperature Range		T <sub>j</sub> ; T <sub>stg</sub>	-55~+150		°C

**Thermal Data**

Parameter	Symbol	Value	Unit
Max. Thermal Resistance, Junction-to-ambient, single device operation	R <sub>th,j-a</sub>	84 *2	°C/W
Max. Thermal Resistance, Junction-to-ambient, single device value at dual operation		101 *2	
Max. Thermal Resistance, Junction-to-case	R <sub>th,j-c</sub>	40	

Note : 1. Pulse width limited by maximum junction temperature.  
 2. Surface mounted on a 1 in<sup>2</sup> pad of 2oz copper, t≤5s. In practice R<sub>th,j-a</sub> will be determined by customer's PCB characteristics. 216°C/W when mounted on a minimum pad of 2 oz. copper.

**N-Channel Characteristics (Tc=25°C, unless otherwise specified)**

Symbol	Min.	Typ.	Max.	Unit	Test Conditions
<b>Static</b>					
BV <sub>DSS</sub>	30	-	-	V	V <sub>GS</sub> =0V, I <sub>D</sub> =250μA
V <sub>GS(th)</sub>	2	-	4		V <sub>DS</sub> = V <sub>GS</sub> , I <sub>D</sub> =250μA
G <sub>FS</sub> *1	-	3	-	S	V <sub>DS</sub> =10V, I <sub>D</sub> =3A
I <sub>GSS</sub>	-	-	±100	nA	V <sub>GS</sub> =±20V, V <sub>DS</sub> =0V
I <sub>DSS</sub>	-	-	1	μA	V <sub>DS</sub> =24V, V <sub>GS</sub> =0V
	-	-	25		V <sub>DS</sub> =24V, V <sub>GS</sub> =0V, T <sub>j</sub> =70°C
R <sub>DS(ON)</sub> *1	-	18	24	mΩ	V <sub>GS</sub> =10V, I <sub>D</sub> =5A
<b>Dynamic</b>					
C <sub>iss</sub>	-	436	-	pF	V <sub>DS</sub> =15V, V <sub>GS</sub> =0V, f=1MHz
C <sub>oss</sub>	-	81	-		
C <sub>rss</sub>	-	60	-		
Q <sub>g</sub> *1, 2	-	9.5	-	nC	V <sub>DS</sub> =15V, V <sub>GS</sub> =10V, I <sub>D</sub> =5A
Q <sub>gs</sub> *1, 2	-	2.5	-		
Q <sub>gd</sub> *1, 2	-	2.8	-		



td(ON) *1, 2	-	8.6	-	ns	V <sub>DS</sub> =15V, I <sub>D</sub> =4A, V <sub>GS</sub> =10V, R <sub>GS</sub> =1 Ω
tr *1, 2	-	14.2	-		
td(OFF) *1, 2	-	18.4	-		
tf *1, 2	-	6.8	-		
Rg	-	7	-	Ω	f=1MHz
<b>Source-Drain Diode</b>					
I <sub>S</sub> *1	-	-	2.3	A	
I <sub>SM</sub> *3	-	-	9.2		
V <sub>SD</sub> *1	-	0.77	1.2	V	I <sub>S</sub> =1A, V <sub>GS</sub> =0V
trr	-	7.6	-	ns	I <sub>F</sub> =1.5A, dI <sub>F</sub> /dt=100A/μs
Qrr	-	2.9	-	nC	

**P-Channel Electrical Characteristics** (T<sub>c</sub>=25°C, unless otherwise specified)

Symbol	Min.	Typ.	Max.	Unit	Test Conditions
<b>Static</b>					
BV <sub>DSS</sub>	-30	-	-	V	V <sub>GS</sub> =0V, I <sub>D</sub> =-250μA
V <sub>GS(th)</sub>	-1.7	-	-2.7		V <sub>DS</sub> =V <sub>GS</sub> , I <sub>D</sub> =-250μA
I <sub>GSS</sub>	-	-	±100	nA	V <sub>GS</sub> =±20V, V <sub>DS</sub> =0V
I <sub>DSS</sub>	-	-	-1	μA	V <sub>DS</sub> =-24V, V <sub>GS</sub> =0V
	-	-	-25		V <sub>DS</sub> =-24V, V <sub>GS</sub> =0V, T <sub>j</sub> =70°C
*R <sub>DS(ON)</sub>	-	32	43	mΩ	V <sub>GS</sub> =-10V, I <sub>D</sub> =-5A
*G <sub>FS</sub>	-	6.5	-	S	V <sub>DS</sub> =-10V, I <sub>D</sub> =-3A
<b>Dynamic</b>					
C <sub>iss</sub>	-	1035	-	pF	V <sub>DS</sub> =-15V, V <sub>GS</sub> =0V, f=1MHz
C <sub>oss</sub>	-	109	-		
C <sub>rss</sub>	-	95	-		
*td(ON)	-	8.6	-	ns	V <sub>DS</sub> =-15V, I <sub>D</sub> =-5A, V <sub>GS</sub> =-10V, R <sub>G</sub> =1 Ω
*tr	-	18.8	-		
*td(OFF)	-	65.8	-		
*tf	-	29.2	-		
*Q <sub>g</sub>	-	20.8	-	nC	V <sub>DS</sub> =-15V, I <sub>D</sub> =-5A, V <sub>GS</sub> =-10V
*Q <sub>gs</sub>	-	3.8	-		
*Q <sub>gd</sub>	-	4.8	-		
R <sub>g</sub>	-	22	-	Ω	f=1MHz
<b>Body Diode</b>					
*I <sub>S</sub>	-	-	-2.3	A	
*I <sub>SM</sub>	-	-	-9.2		
*V <sub>SD</sub>	-	-0.76	-1.2	V	V <sub>GS</sub> =0V, I <sub>S</sub> =-1A
*trr	-	11	-	ns	I <sub>F</sub> =-5A, V <sub>GS</sub> =0V, dI <sub>F</sub> /dt=100A/μs
*Qrr	-	5.9	-	nC	

Note : \*1.Pulse Test : Pulse Width ≤300μs, Duty Cycle≤2%  
 \*2.Independent of operating temperature  
 \*3.Pulse width limited by maximum junction temperature.

### Recommended Soldering Footprint

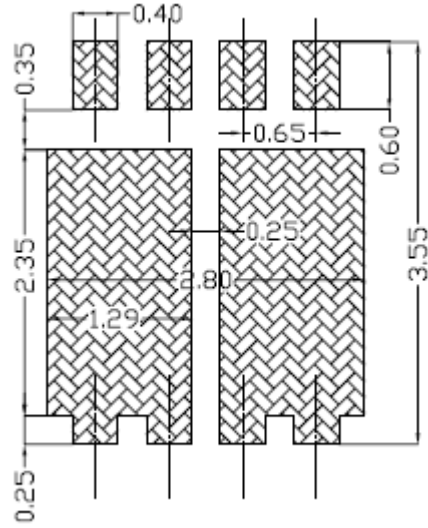

unit : mm



**Typical Characteristics : Q1( N-channel )**

Typical Output Characteristics

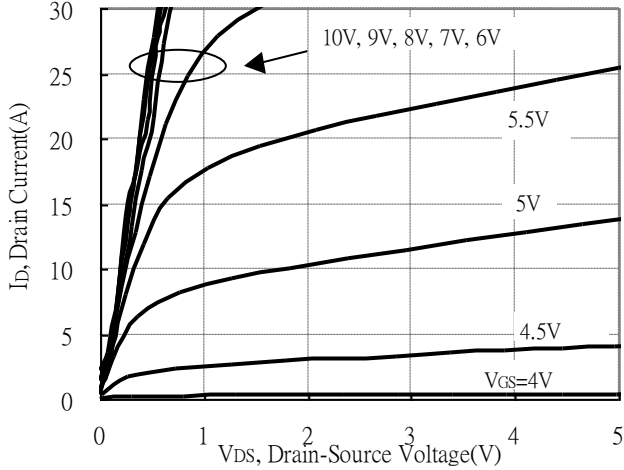

Breakdown Voltage vs Ambient Temperature

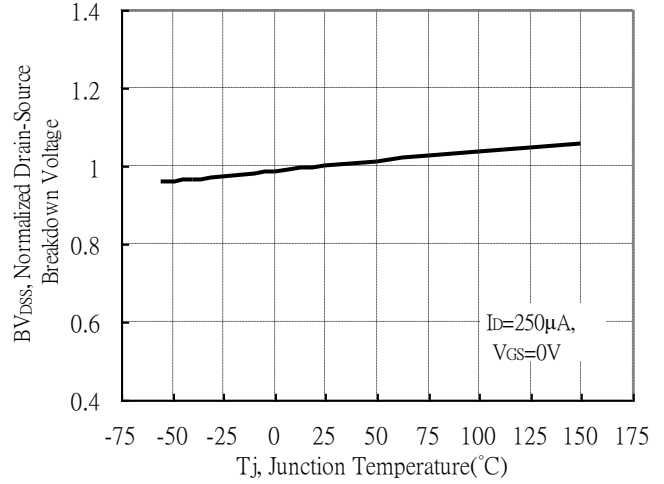

Static Drain-Source On-State resistance vs Drain Current

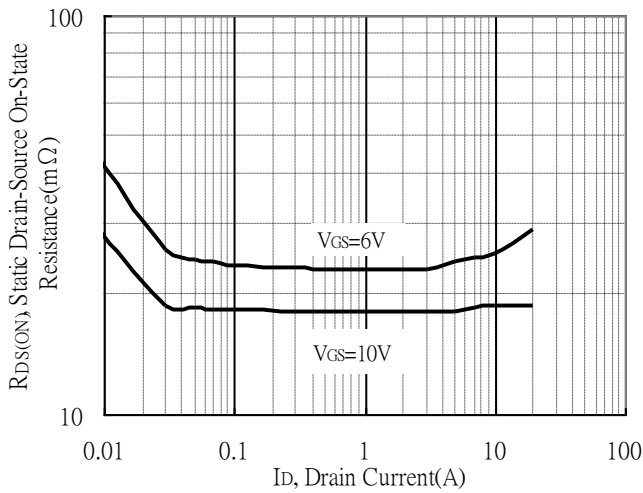

Reverse Drain Current vs Source-Drain Voltage

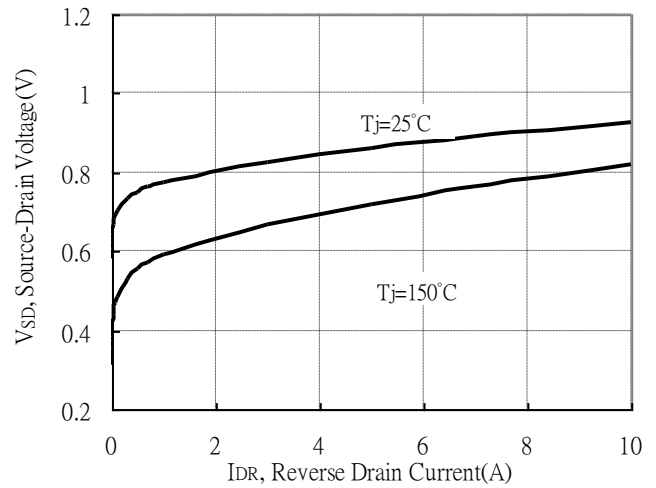

Static Drain-Source On-State Resistance vs Gate-Source Voltage

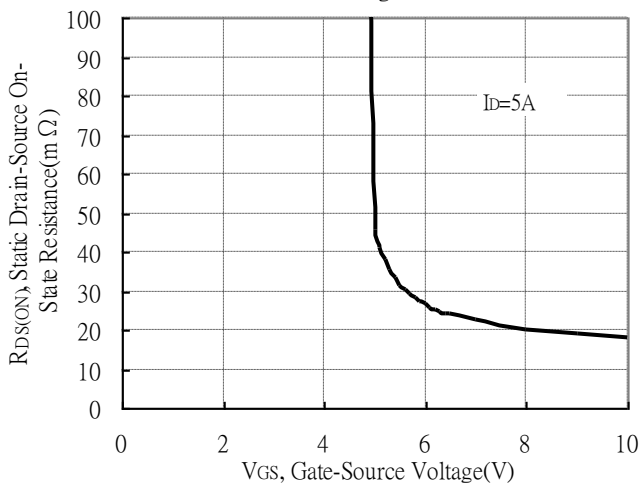

Drain-Source On-State Resistance vs Junction Temperature

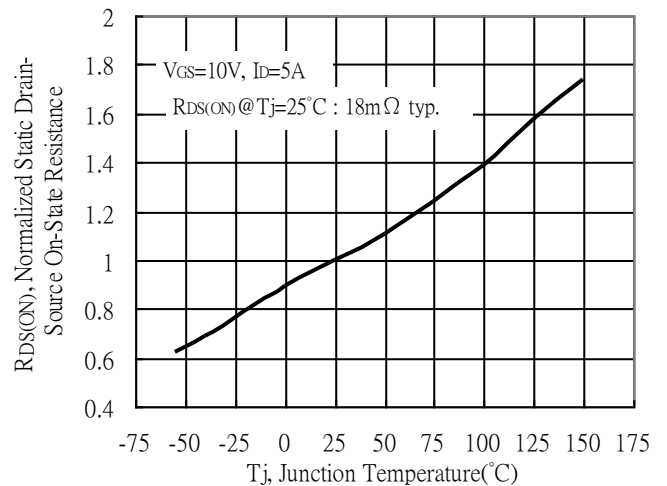

## Typical Characteristics(Cont.) : Q1( N-channel)

Capacitance vs Drain-to-Source Voltage

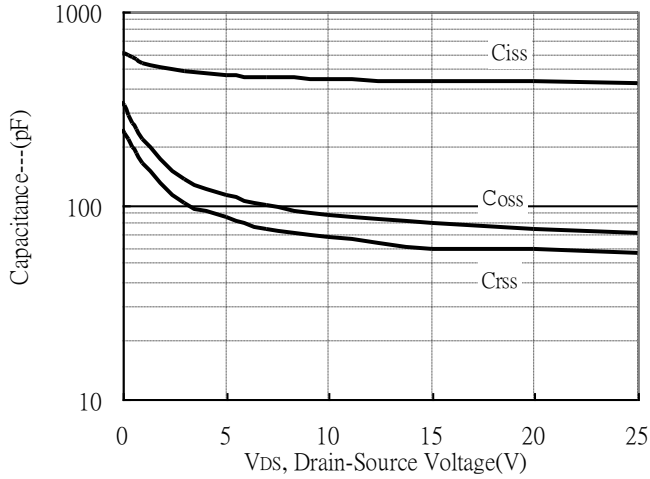

Threshold Voltage vs Junction Temperature

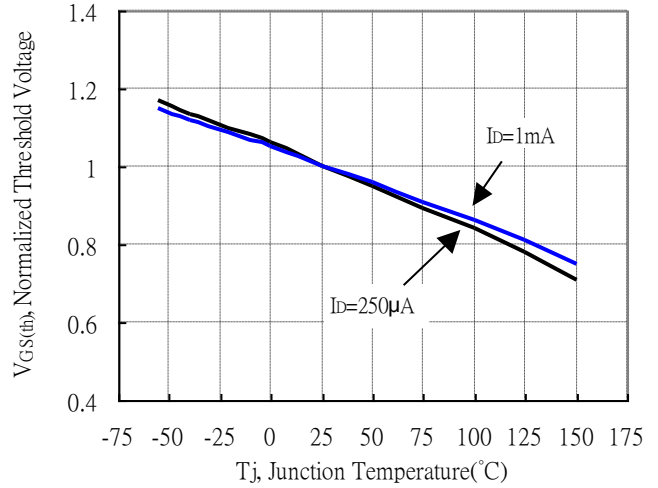

Forward Transfer Admittance vs Drain Current

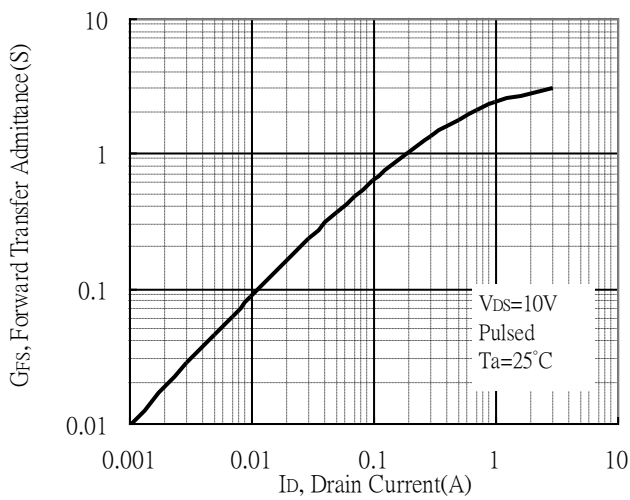

Gate Charge Characteristics

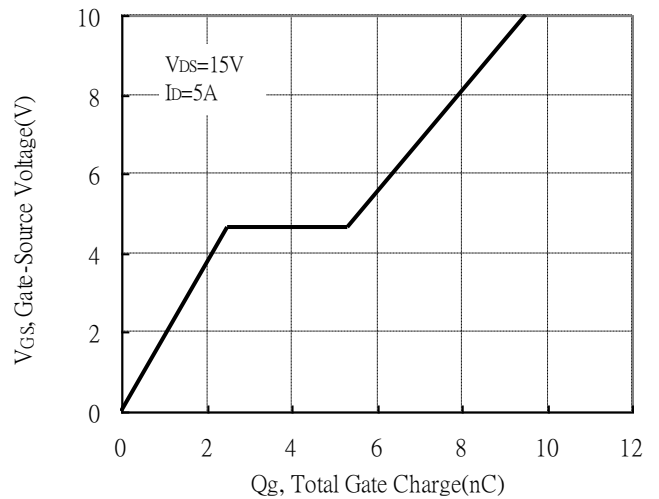

Maximum Safe Operating Area

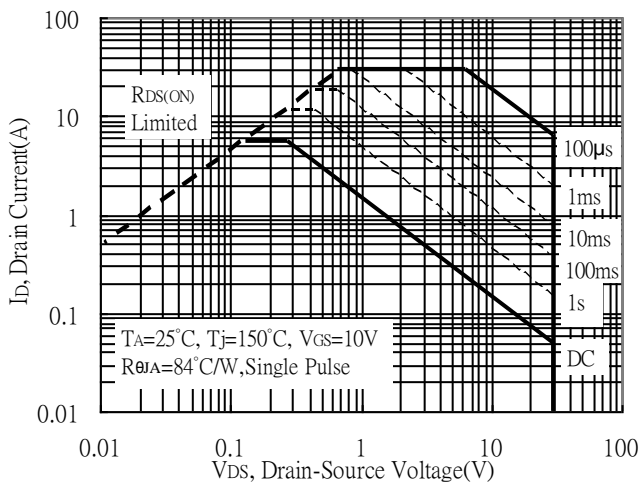

Maximum Drain Current vs Case Temperature

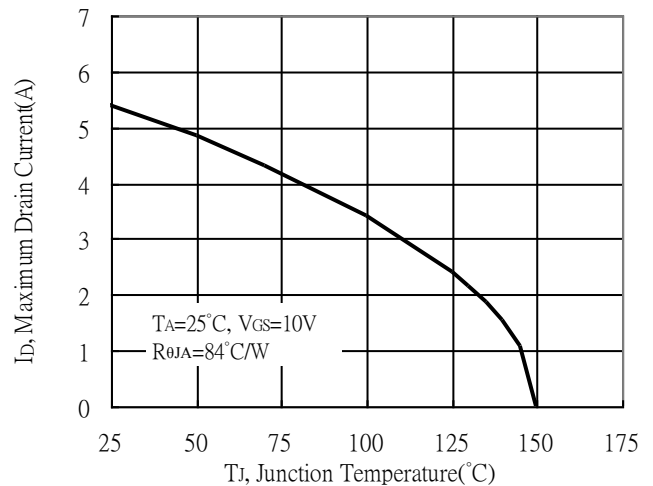



**Typical Characteristics(Cont.) : Q1( N-channel)**

Typical Transfer Characteristics

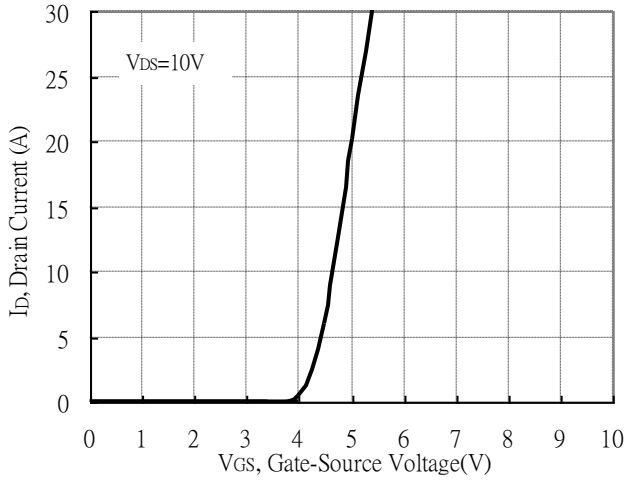

Single Pulse Power Rating, Junction to Ambient  
 (Note on page 2)

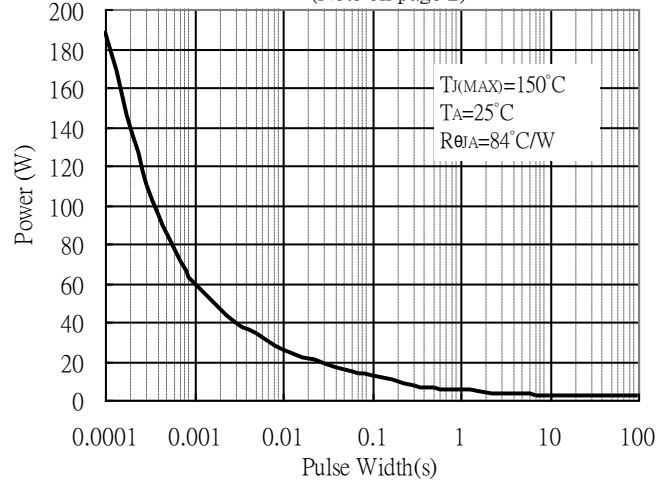

Transient Thermal Response Curves

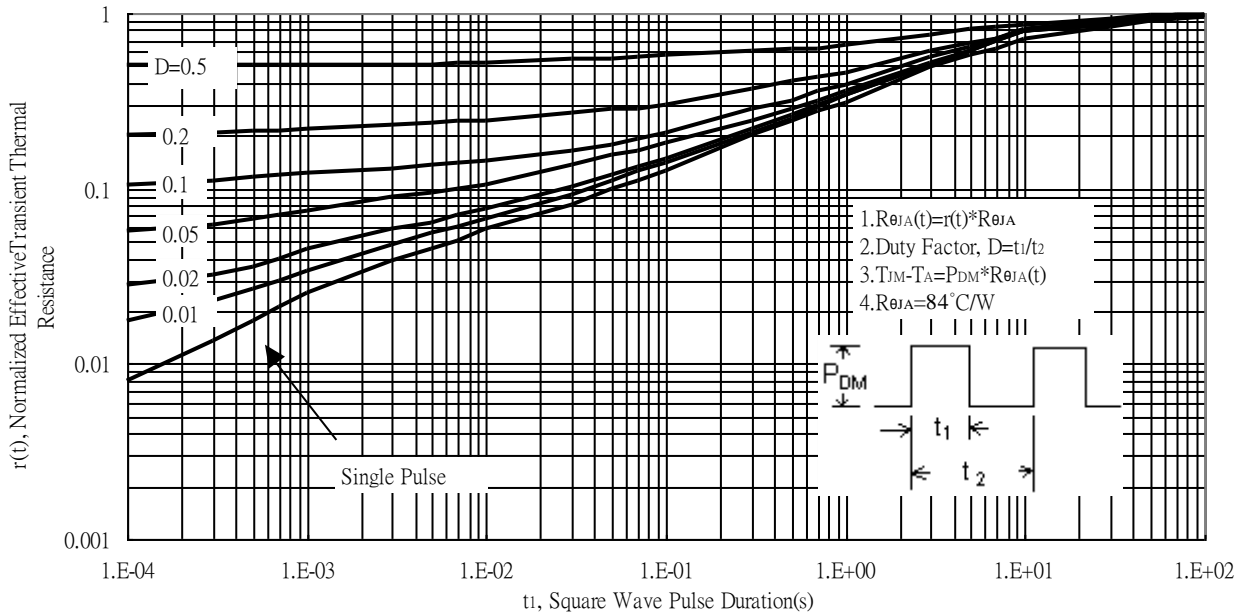

## Typical Characteristics : Q2( P-channel)

Typical Output Characteristics

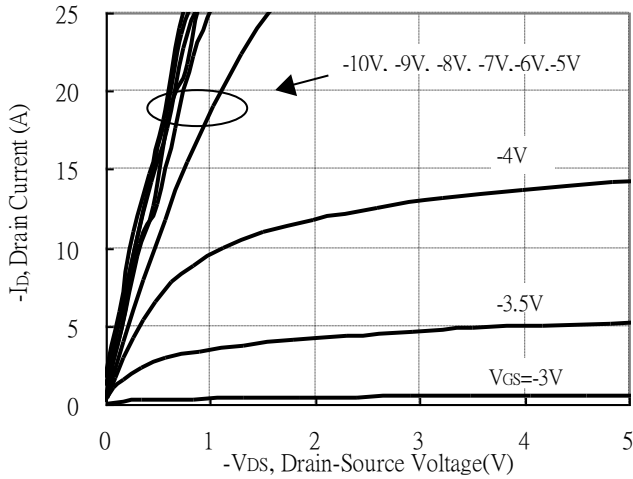

Brekdown Voltage vs Ambient Temperature

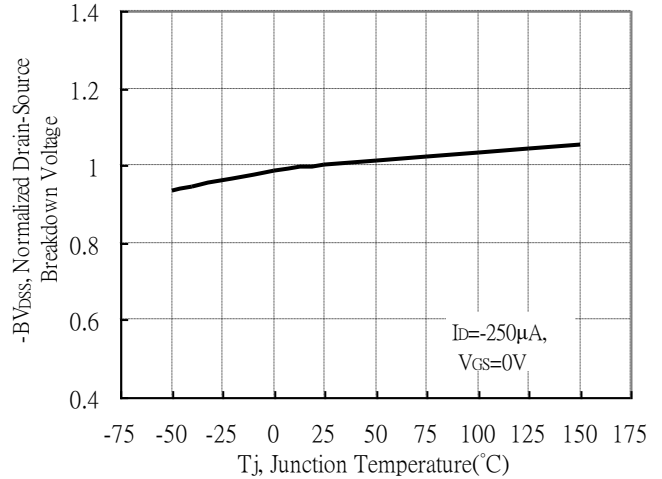

Static Drain-Source On-State resistance vs Drain Current

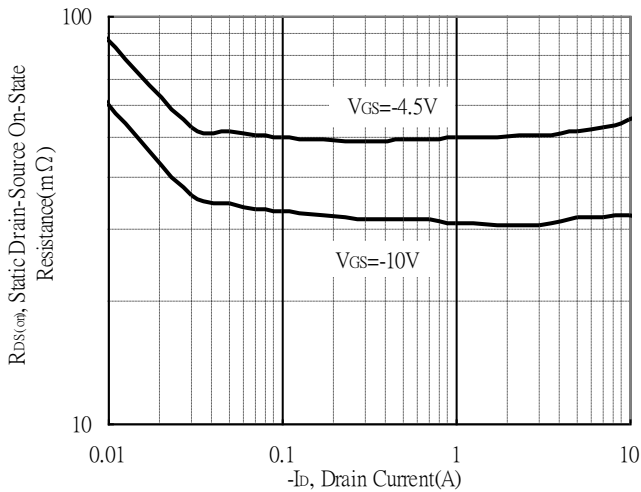

Source Drain Current vs Source-Drain Voltage

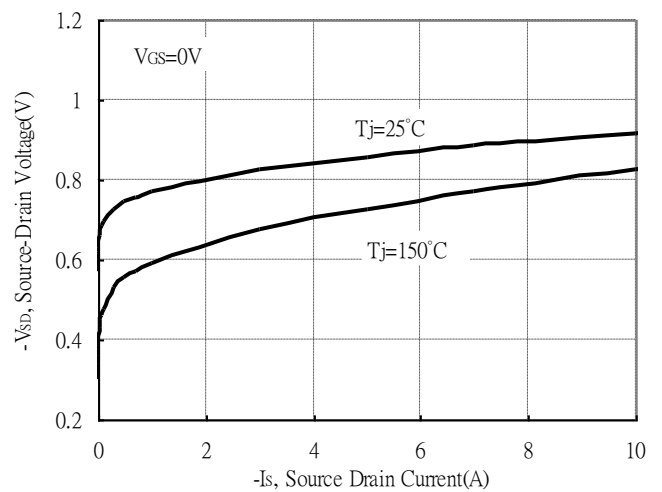

Static Drain-Source On-State Resistance vs Gate-Source Voltage

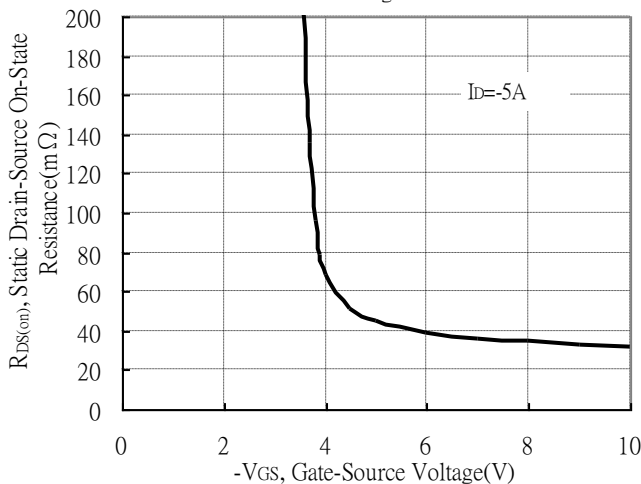

Drain-Source On-State Resistance vs Junction Temperature

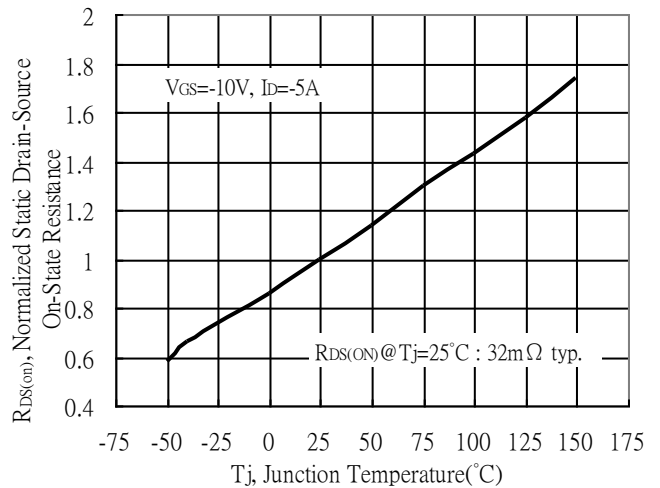





**Typical Characteristics(Cont.) : Q2(P-channel)**

Capacitance vs Drain-to-Source Voltage

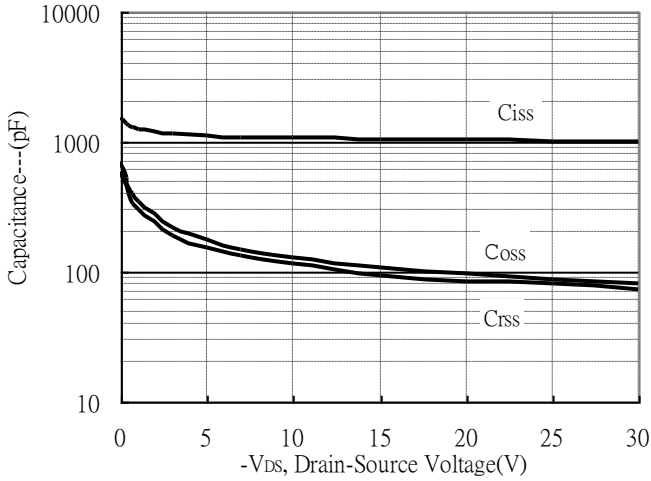

Threshold Voltage vs Junction Temperature

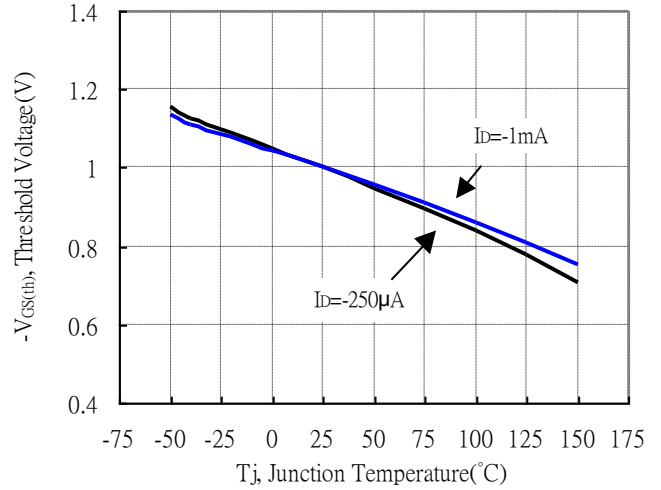

Forward Transfer Admittance vs Drain Current

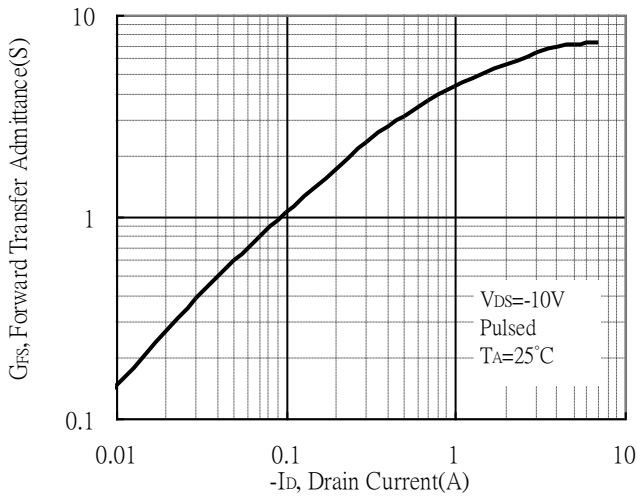

Gate Charge Characteristics

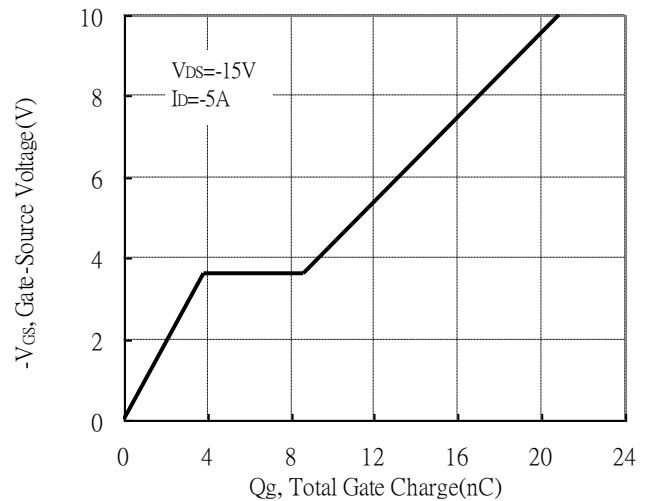

Maximum Safe Operating Area

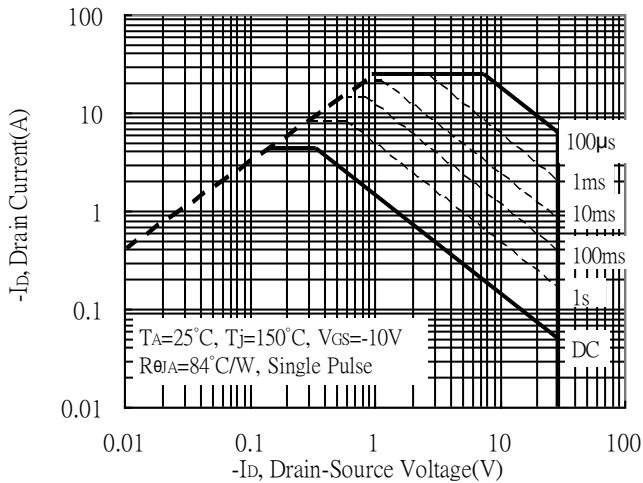

Maximum Drain Current vs Junction Temperature

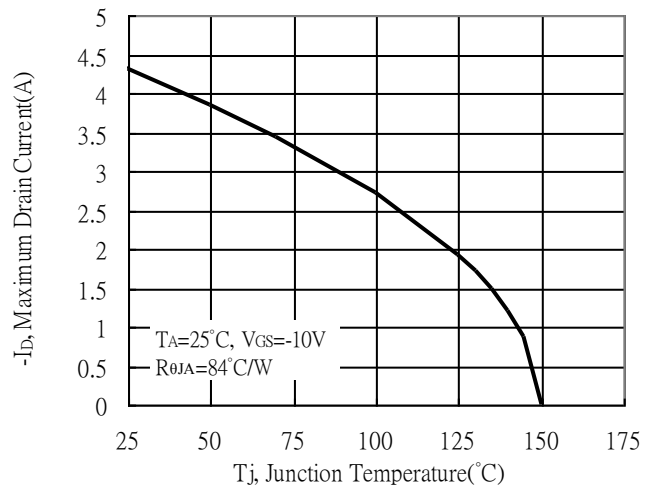



**Typical Characteristics(Cont.) : Q2(P-channel)**

Typical Transfer Characteristics

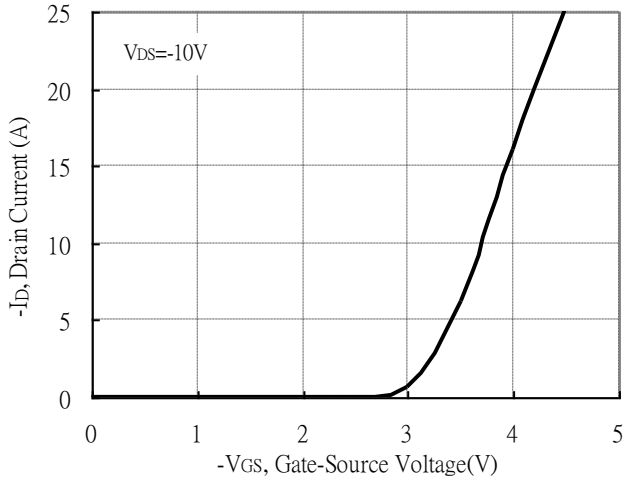

Single Pulse Power Rating, Junction to Ambient  
 (Note on page 2)

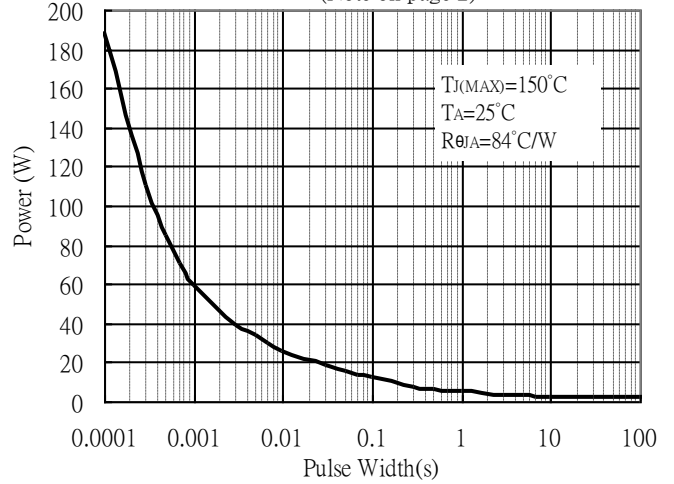

Transient Thermal Response Curves

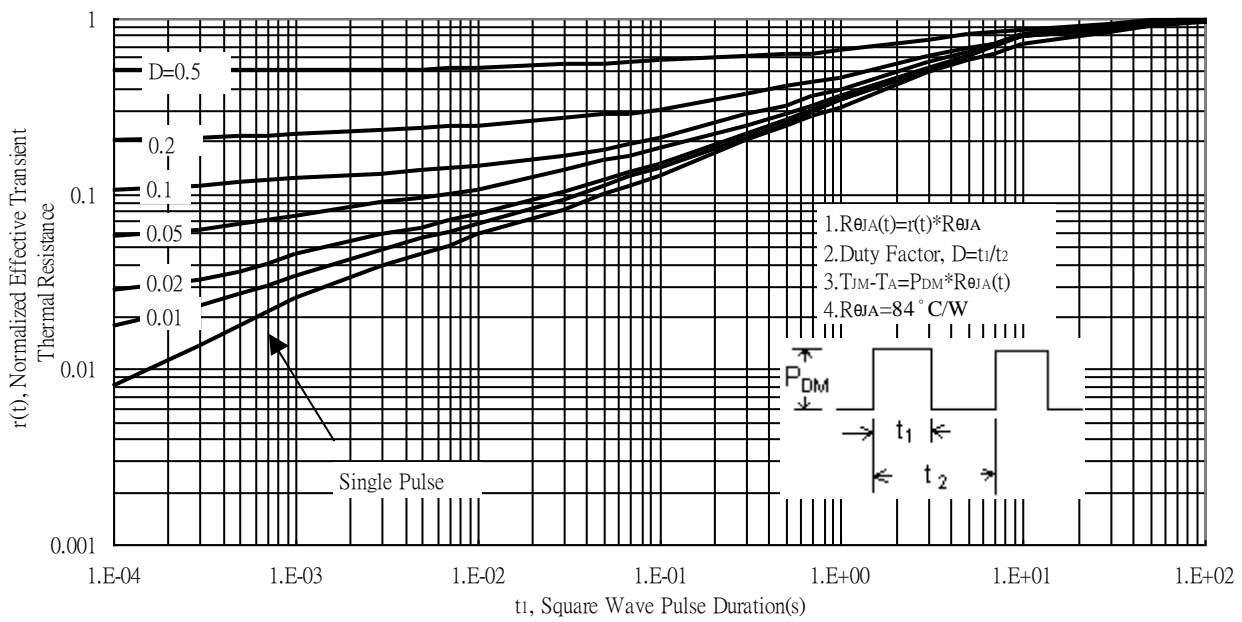

**Reel Dimension**

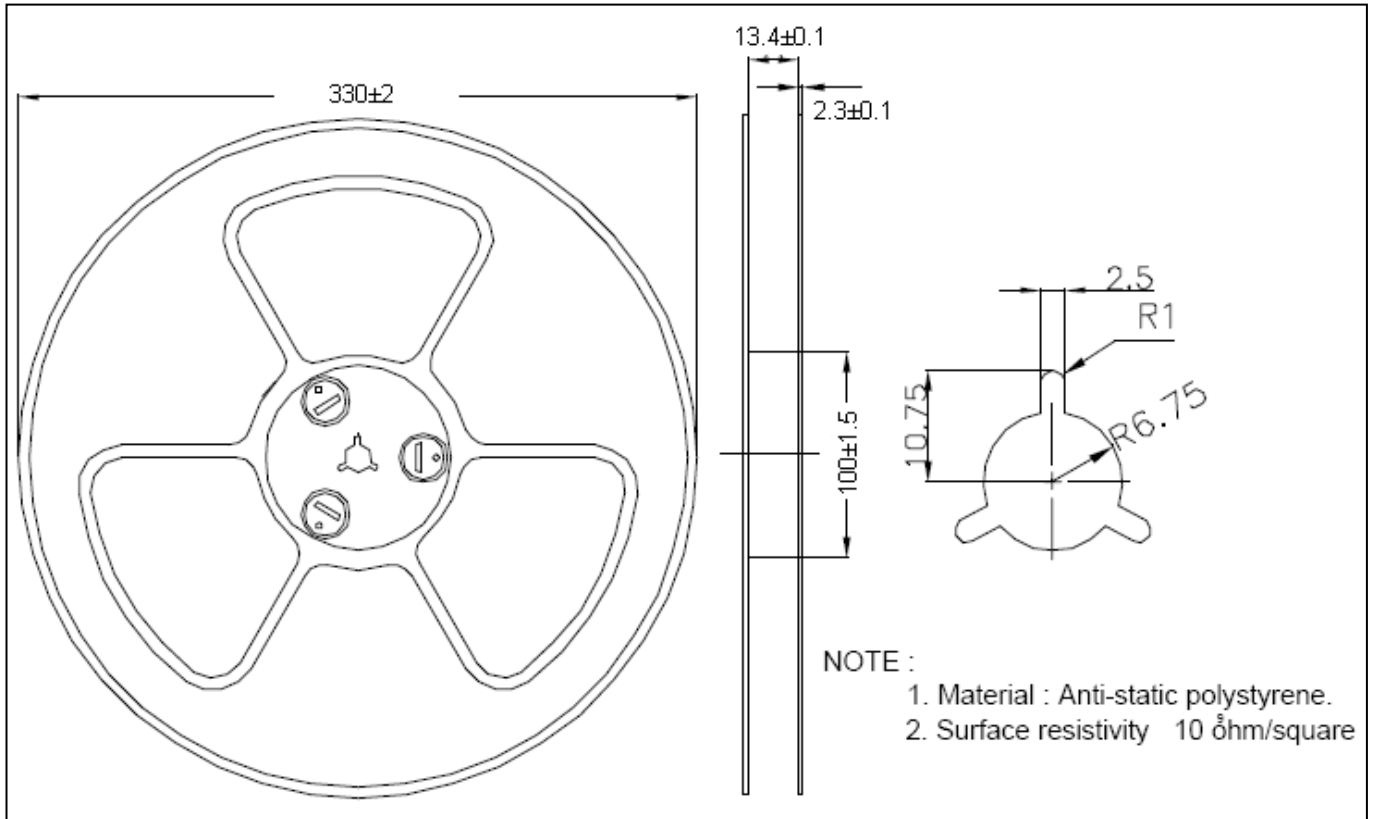

**Carrier Tape**

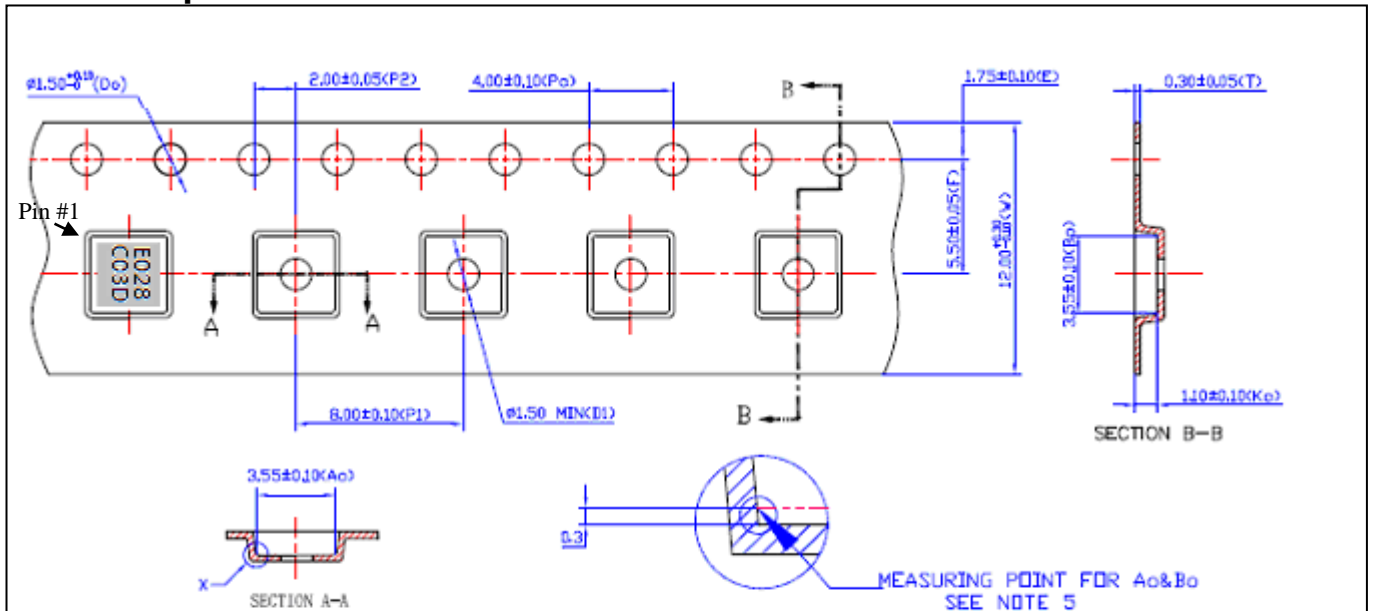

**Note :**

- 1.10 sprocket hole pitch cumulative tolerance :  $\pm 0.2\text{mm}$ .
- 2.Camber : Reference to carrier tape inspection manual.
- 3.Material : black conductive polystyrene.
- 4.All dimensions are in millimeters(unless otherwise specified).
- 5.Ao and Bo measured on a plane 0.3mm above the bottom of the pocket.
- 6.Ko measured from a plane on the inside bottom of the pocket to the top surface of the carrier.
- 7.Pocket position relative to sprocket hole measured as true position of the pocket, not pocket hole.
- 8.Surface resistivity :  $1 \times 10^4 \sim 1 \times 10^{11} \text{ ohms/sq}$

**Recommended wave soldering condition**

Product	Peak Temperature	Soldering Time
Pb-free devices	260 +0/-5 °C	5 +1/-1 seconds

**Recommended temperature profile for IR reflow**

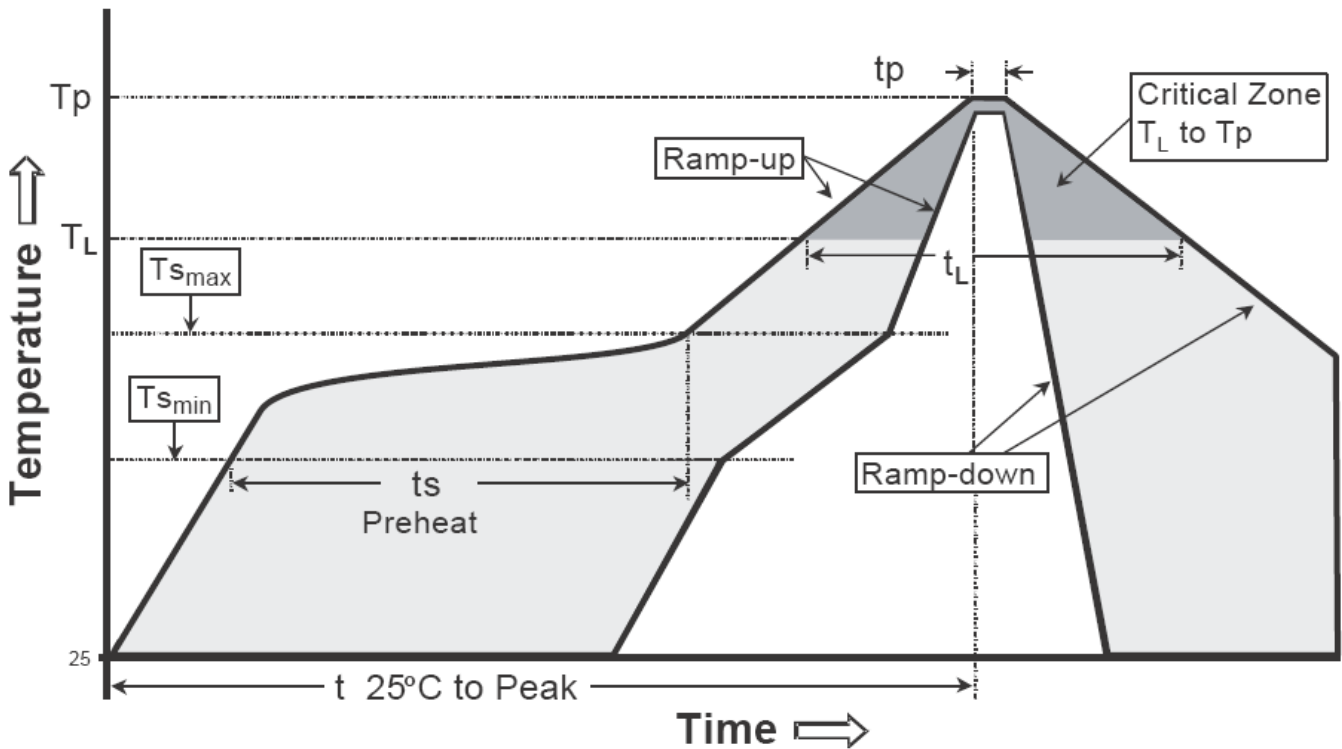

Profile feature	Sn-Pb eutectic Assembly	Pb-free Assembly
Average ramp-up rate (Tsmax to Tp)	3°C/second max.	3°C/second max.
Preheat		
-Temperature Min(Ts min)	100°C	150°C
-Temperature Max(Ts max)	150°C	200°C
-Time(ts min to ts max)	60-120 seconds	60-180 seconds
Time maintained above:		
-Temperature (Tl)	183°C	217°C
- Time (tl)	60-150 seconds	60-150 seconds
Peak Temperature(Tp)	240 +0/-5 °C	260 +0/-5 °C
Time within 5°C of actual peak temperature(tp)	10-30 seconds	20-40 seconds
Ramp down rate	6°C/second max.	6°C/second max.
Time 25 °C to peak temperature	6 minutes max.	8 minutes max.

Note : All temperatures refer to topside of the package, measured on the package body surface.

**DFN3x3 Dimension**

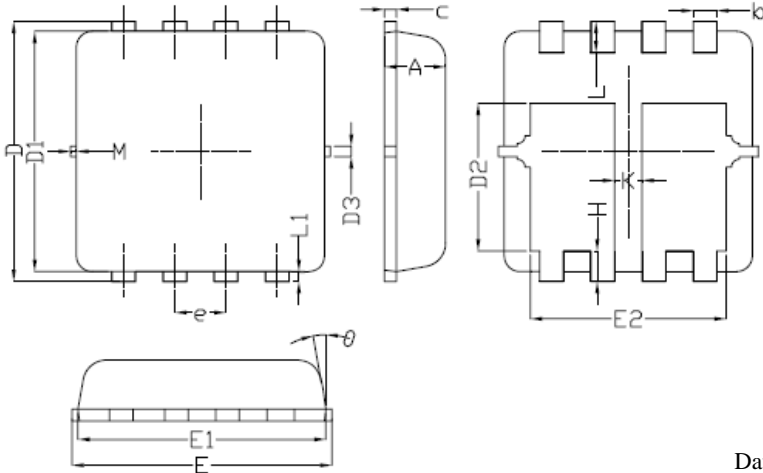

**Marking:**

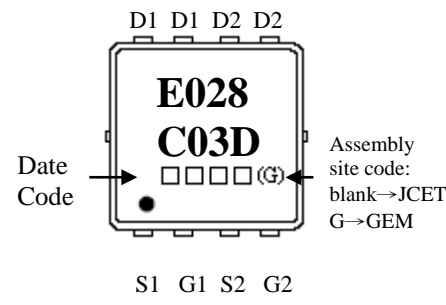

Assembly site code:  
 blank→JCET  
 G→GEM

**Note:**

- All Dimension Are In mm.
- Package Body Sizes Exclude Mold Flash, Protrusion Or Gate Burrs. Mold Flash, Protrusion Or Gate Burrs Shall Not Exceed 0.10 mm Per Side.
- Package Body Sizes Determined At The Outermost Extremes Of The Plastic Body Exclusive Of Mold Flash, Tie Bar Burrs, Gate Burrs And Interlead Flash, But Including Any Mismatch Between The Top And Bottom Of The Plastic Body.

Date Code(counting from left to right) :

1<sup>st</sup> code: year code, the last digit of Christian year  
 2<sup>nd</sup> code : month code, Jan→A, Feb→B, Mar→C, Apr→D  
 May→E, Jun→F, Jul→G, Aug→H, Sep→J,  
 Oct→K, Nov→L, Dec→M  
 3<sup>rd</sup> and 4<sup>th</sup> codes : production serial number, 01~99

**8-Lead DFN3x3 Plastic Package  
 CYStek Package Code: V8**

DIM	Millimeters		Inches		DIM	Millimeters		Inches	
	Min.	Max.	Min.	Max.		Min.	Max.	Min.	Max.
A	0.65	0.85	0.026	0.033	E2	2.30	2.60	0.091	0.102
b	0.20	0.40	0.008	0.016	e	0.65 BSC		0.026 BSC	
c	0.10	0.25	0.004	0.010	H	0.30	0.50	0.012	0.020
D	3.15	3.45	0.124	0.136	L	0.30	0.50	0.012	0.020
D1	2.90	3.20	0.114	0.126	L1	0.13 TYP.		0.005 TYP.	
D2	1.54	1.98	0.061	0.078	K	0.30	-	0.012	-
D3	0.13 TYP.		0.005 TYP.		θ	8°	13°	8°	13°
E	3.20	3.40	0.126	0.134	M	-	0.15	-	0.006
E1	2.90	3.20	0.114	0.126					

- Notes:**
- Controlling dimension: millimeters.
  - Maximum lead thickness includes lead finish thickness, and minimum lead thickness is the minimum thickness of base material.
  - If there is any question with packing specification or packing method, please contact your local CYStek sales office.

**Material:**

- Lead: pure tin plated.
- Mold Compound: Epoxy resin family, flammability solid burning class: UL94V-0.

**Important Notice:**

- All rights are reserved. Reproduction in whole or in part is prohibited without the prior written approval of CYStek.
- CYStek reserves the right to make changes to its products without notice.
- CYStek **semiconductor products are not warranted to be suitable for use in Life-Support Applications, or systems.**
- CYStek assumes no liability for any consequence of customer product design, infringement of patents, or application assistance.