

# N-Channel Enhancement Mode Power MOSFET

## MTE020N10RF3

### Features

- Low On Resistance
- Simple Drive Requirement
- Low Gate Charge
- Fast Switching Characteristic
- RoHS compliant package

<b>BV<sub>DSS</sub></b>	<b>100V</b>
<b>I<sub>D</sub>@T<sub>C</sub>=25°C, V<sub>GS</sub>=10V</b>	<b>42A</b>
<b>R<sub>DSON</sub>@V<sub>GS</sub>=10V, I<sub>D</sub>=20A</b>	<b>21 mΩ (typ)</b>

### Symbol

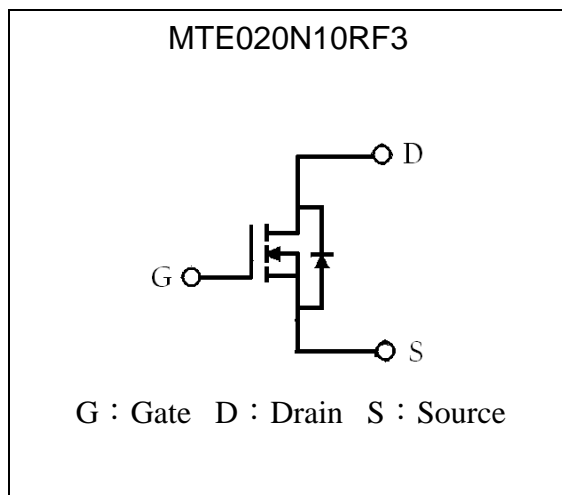

### Outline

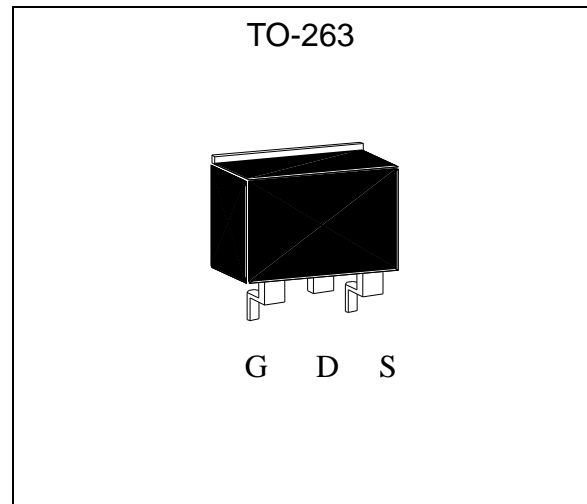

### Ordering Information

Device	Package	Shipping
MTE020N10RF3-0-T7-X	TO-263 (Pb-free lead plating and RoHS compliant package)	800 pcs / Tape & Reel

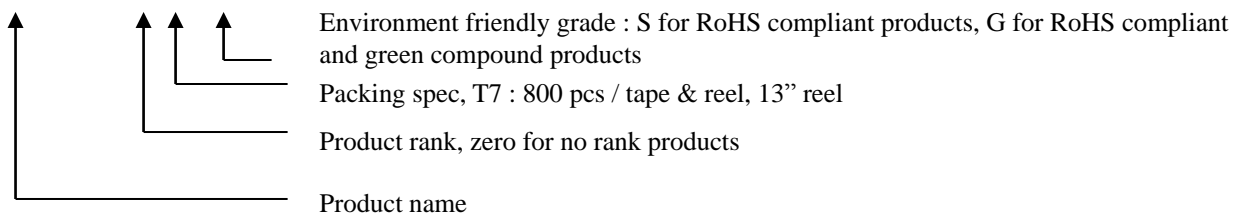

**Absolute Maximum Ratings** ( $T_C=25^{\circ}\text{C}$ )

Parameter	Symbol	Limits	Unit	
Drain-Source Voltage (Note 1)	$V_{DS}$	100	V	
Gate-Source Voltage	$V_{GS}$	$\pm 25$		
Continuous Drain Current @ $T_C=25^{\circ}\text{C}$ , $V_{GS}=10\text{V}$ (Note 1)	$I_D$	42*	A	
Continuous Drain Current @ $T_C=100^{\circ}\text{C}$ , $V_{GS}=10\text{V}$ (Note 1)		29.7*		
Continuous Drain Current @ $T_A=25^{\circ}\text{C}$ , $V_{GS}=10\text{V}$ (Note 2)	$I_{DSM}$	6.2		
Continuous Drain Current @ $T_A=70^{\circ}\text{C}$ , $V_{GS}=10\text{V}$ (Note 2)		5		
Pulsed Drain Current @ $V_{GS}=10\text{V}$ (Note 3)	$I_{DM}$	100*		
Single Pulse Avalanche Current @ $L=0.1\text{mH}$ (Note 3)	$I_{AS}$	32		
Single Pulse Avalanche Energy @ $L=1\text{mH}$ , $I_D=15\text{Amps}$ , $V_{DD}=25\text{V}$ (Note 4)	$E_{AS}$	112		mJ
Repetitive Avalanche Energy (Note 3)	$E_{AR}$	10	W	
Power Dissipation	$T_C=25^{\circ}\text{C}$ (Note 1)	$P_D$		100
	$T_C=100^{\circ}\text{C}$ (Note 1)	$P_D$		50
	$T_A=25^{\circ}\text{C}$ (Note 2)	$P_{DSM}$		2.1
	$T_A=70^{\circ}\text{C}$ (Note 2)			1.4
Operating Junction and Storage Temperature	$T_j, T_{stg}$	-55~+175		

\*Drain current limited by maximum junction temperature

**Thermal Data**

Parameter	Symbol	Value	Unit
Thermal Resistance, Junction-to-case, max	$R_{\theta JC}$	1.5	$^{\circ}\text{C}/\text{W}$
Thermal Resistance, Junction-to-ambient, max (Note 2)	$R_{\theta JA}$	58	

Note : 1. The power dissipation  $P_D$  is based on  $T_{J(MAX)}=175^{\circ}\text{C}$ , using junction-to-case thermal resistance, and is more useful in setting the upper dissipation limit for cases where additional heatsinking is used.

2. The value of  $R_{\theta JA}$  is measured with the device mounted on 1 in<sup>2</sup> FR-4 board with 2 oz. copper, in a still air environment with  $T_A=25^{\circ}\text{C}$ . The power dissipation  $P_{DSM}$  is based on  $R_{\theta JA}$  and the maximum allowed junction temperature of  $150^{\circ}\text{C}$ . The value in any given application depends on the user's specific board design, and the maximum temperature of  $175^{\circ}\text{C}$  may be used if the PCB allows it.

3. Repetitive rating, pulse width limited by junction temperature  $T_{J(MAX)}=175^{\circ}\text{C}$ . Ratings are based on low frequency and low duty cycles to keep initial  $T_J=25^{\circ}\text{C}$ .

4. 100% tested by conditions of  $L=0.1\text{mH}$ ,  $I_{AS}=20\text{A}$ ,  $V_{GS}=10\text{V}$ ,  $V_{DD}=25\text{V}$



**Characteristics (Tj=25°C, unless otherwise specified)**

Symbol	Min.	Typ.	Max.	Unit	Test Conditions
<b>Static</b>					
BV <sub>DSS</sub>	100	-	-	V	V <sub>GS</sub> =0V, I <sub>D</sub> =250μA
ΔBV <sub>DSS</sub> /ΔT <sub>j</sub>	-	0.1	-	V/°C	Reference to 25°C, I <sub>D</sub> =250μA
V <sub>GS(th)</sub>	2.0	-	4.0	V	V <sub>DS</sub> = V <sub>GS</sub> , I <sub>D</sub> =250μA
*G <sub>FS</sub>	-	11.8	-	S	V <sub>DS</sub> =10V, I <sub>D</sub> =20A
I <sub>GSS</sub>	-	-	±100	nA	V <sub>GS</sub> =±25V, V <sub>DS</sub> =0V
I <sub>DSS</sub>	-	-	1	μA	V <sub>DS</sub> =80V, V <sub>GS</sub> =0V
I <sub>DSS</sub>	-	-	25		V <sub>DS</sub> =80V, V <sub>GS</sub> =0V, T <sub>j</sub> =125°C
*R <sub>DS(ON)</sub>	-	21	30	mΩ	V <sub>GS</sub> =10V, I <sub>D</sub> =20A
<b>Dynamic</b>					
*Q <sub>g</sub>	-	15.5	-	nC	V <sub>DD</sub> =50V, I <sub>D</sub> =20A, V <sub>GS</sub> =10V
*Q <sub>gs</sub>	-	5.4	-		
*Q <sub>gd</sub>	-	4.1	-		
*t <sub>d(ON)</sub>	-	13.8	-	ns	V <sub>DD</sub> =50V, I <sub>D</sub> =20A, V <sub>GS</sub> =10V, R <sub>G</sub> =3Ω
*t <sub>r</sub>	-	16.8	-		
*t <sub>d(OFF)</sub>	-	22.6	-		
*t <sub>f</sub>	-	7.2	-		
C <sub>iss</sub>	-	965	-	pF	V <sub>GS</sub> =0V, V <sub>DS</sub> =50V, f=1MHz
C <sub>oss</sub>	-	161	-		
C <sub>rss</sub>	--	22	-		
R <sub>g</sub>	-	1.1	-	Ω	f=1MHz
<b>Source-Drain Diode</b>					
*I <sub>S</sub>	-	-	42	A	
*I <sub>SM</sub>	-	-	150		
*V <sub>SD</sub>	-	0.74	1	V	I <sub>S</sub> =1A, V <sub>GS</sub> =0V
*t <sub>rr</sub>	-	27	-	ns	V <sub>GS</sub> =0V, I <sub>F</sub> =20A, dI <sub>F</sub> /dt=100A/μs
*Q <sub>rr</sub>	-	30	-	nC	

\*Pulse Test : Pulse Width ≤300μs, Duty Cycle≤2%



**Typical Characteristics**

Typical Output Characteristics

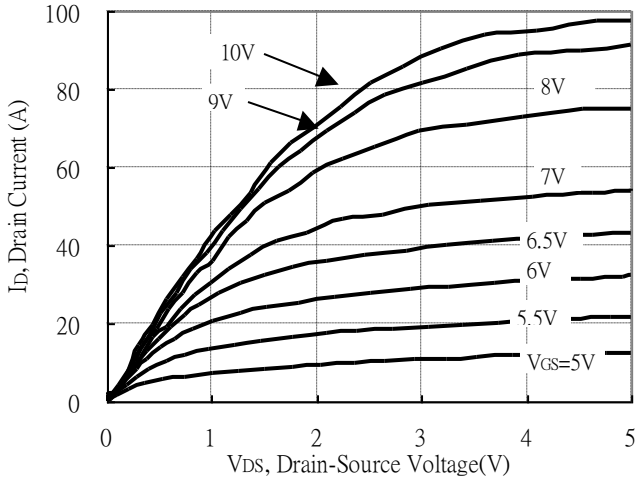

Brekdown Voltage vs Ambient Temperature

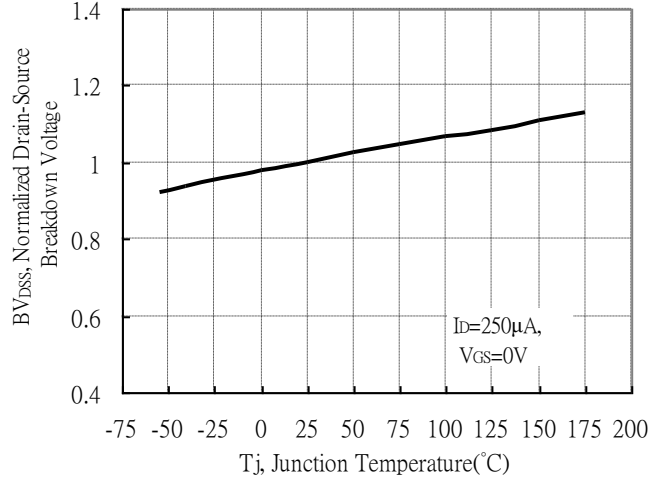

Static Drain-Source On-State resistance vs Drain Current

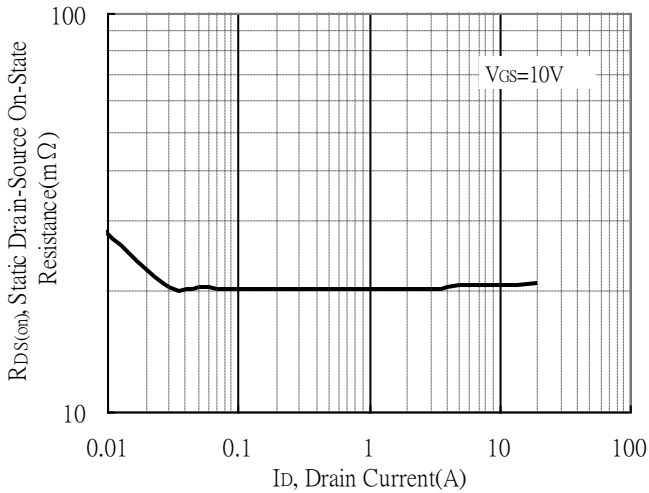

Reverse Drain Current vs Source-Drain Voltage

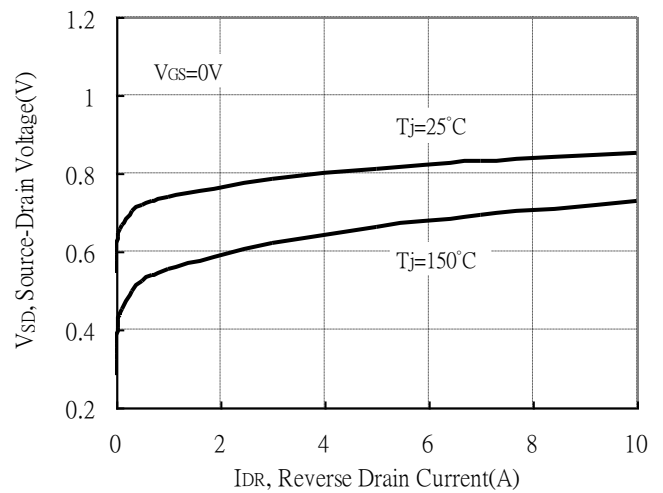

Static Drain-Source On-State Resistance vs Gate-Source Voltage

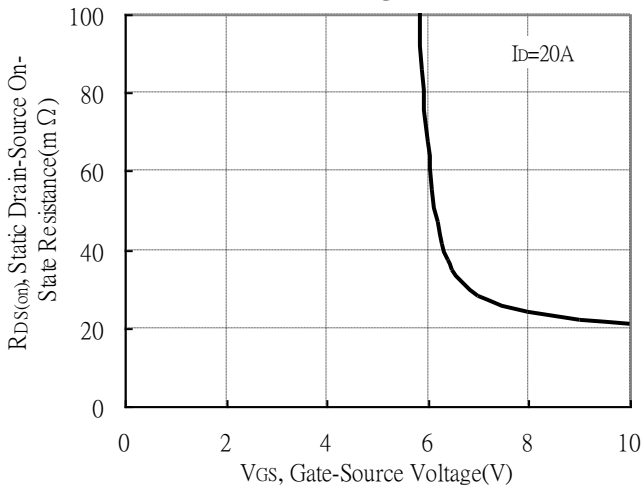

Drain-Source On-State Resistance vs Junction Temperature

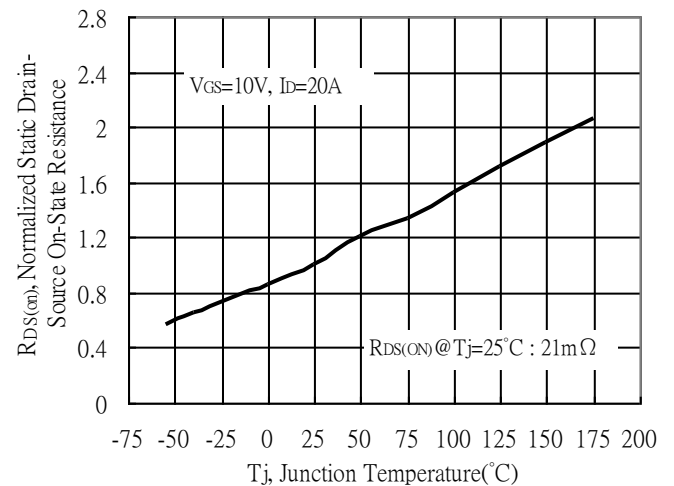

## Typical Characteristics(Cont.)

Capacitance vs Drain-to-Source Voltage

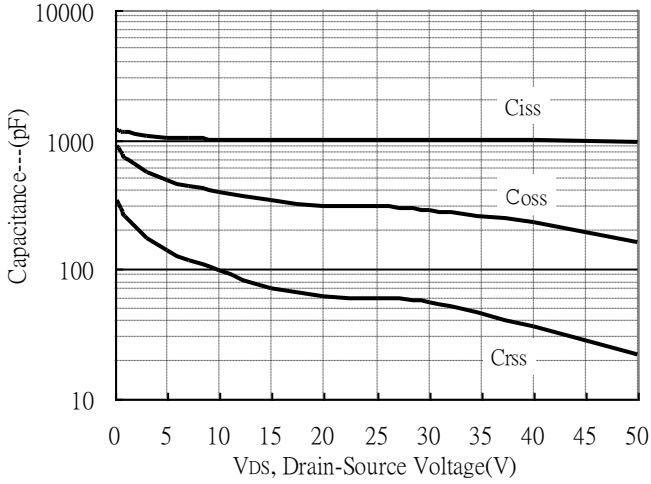

Threshold Voltage vs Junction Temperature

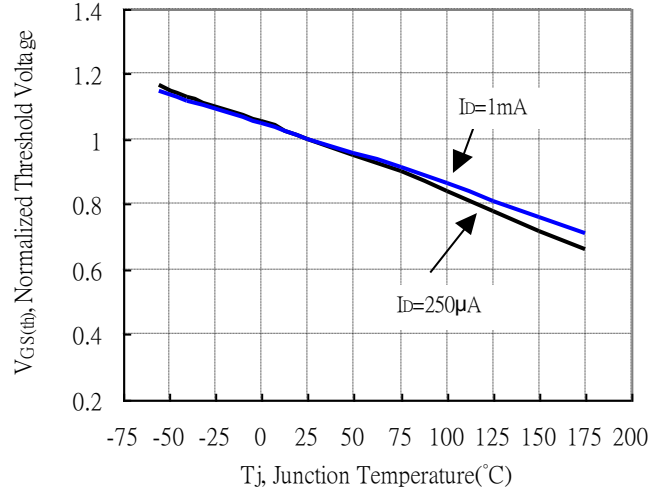

Forward Transfer Admittance vs Drain Current

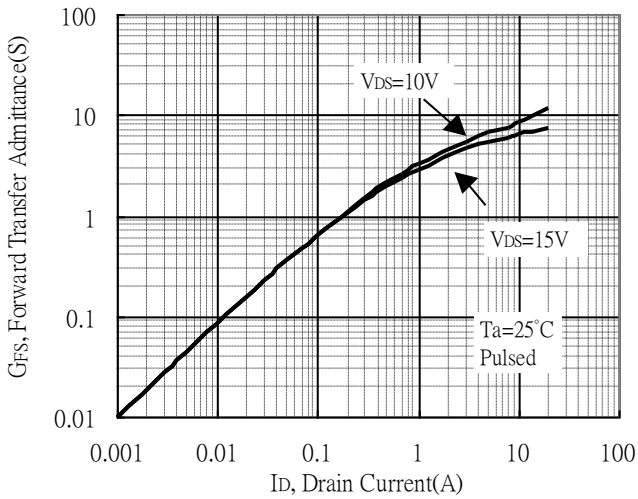

Gate Charge Characteristics

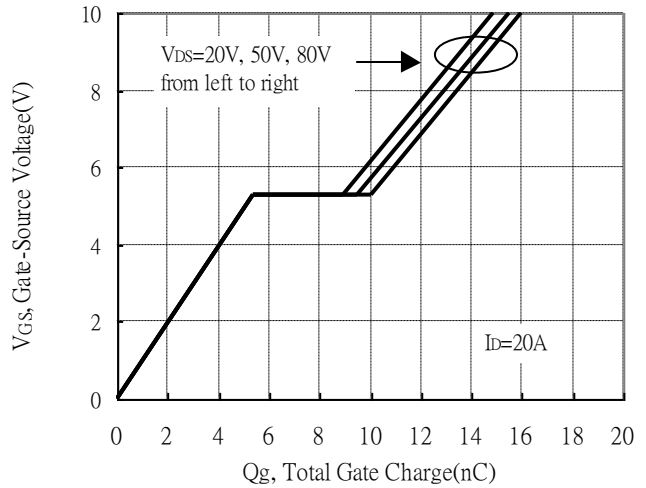

Maximum Safe Operating Area

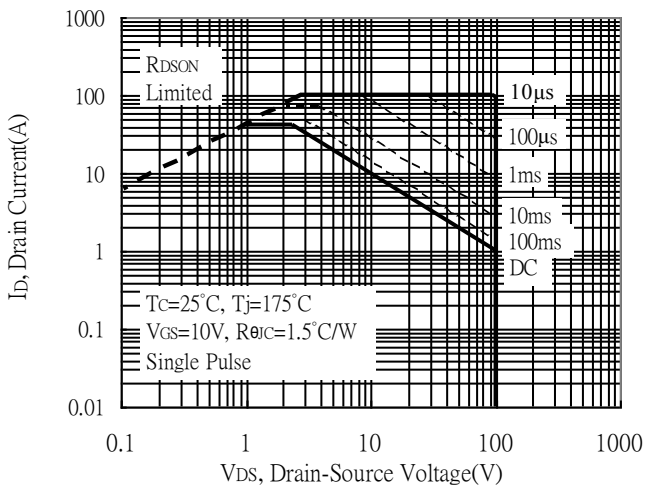

Maximum Drain Current vs Case Temperature

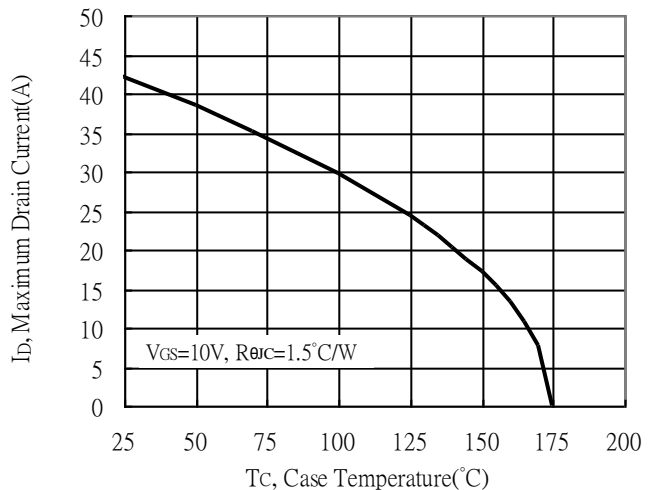



### Typical Characteristics(Cont.)

Typical Transfer Characteristics

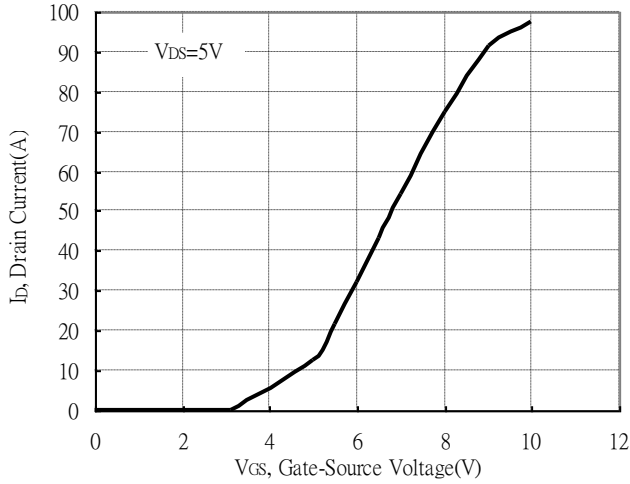

Single Pulse Power Rating, Junction to Case

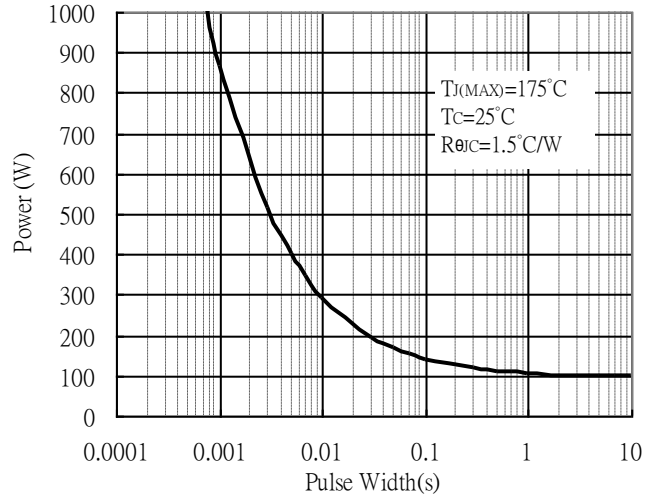

Transient Thermal Response Curves

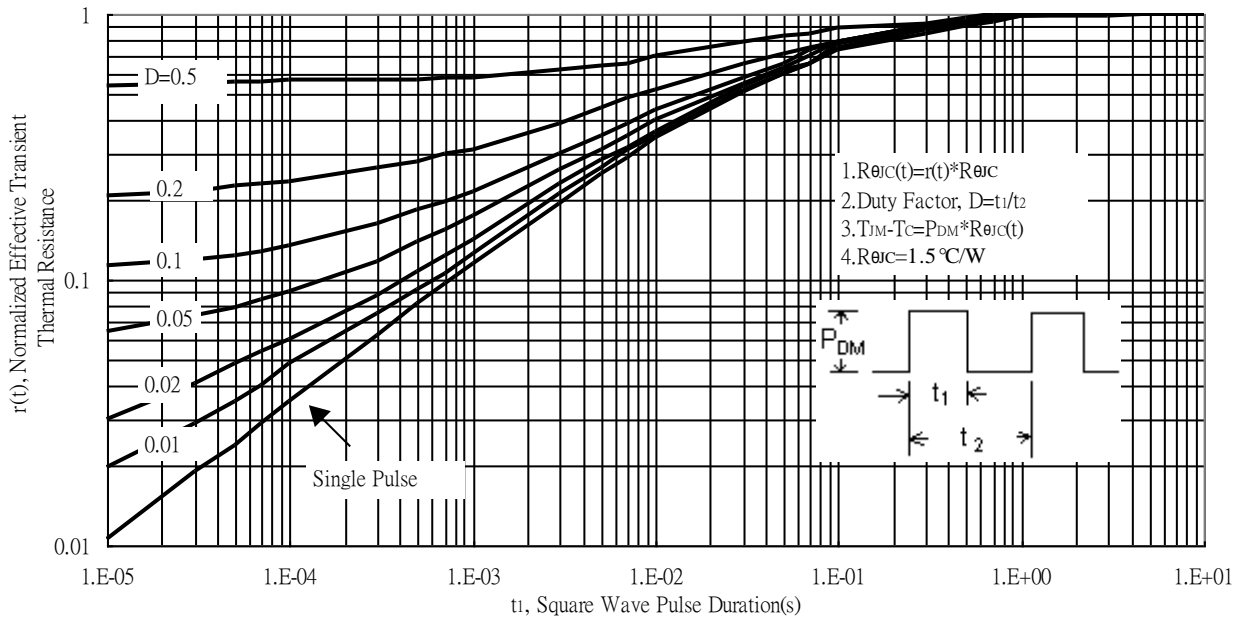

**Reel Dimension**

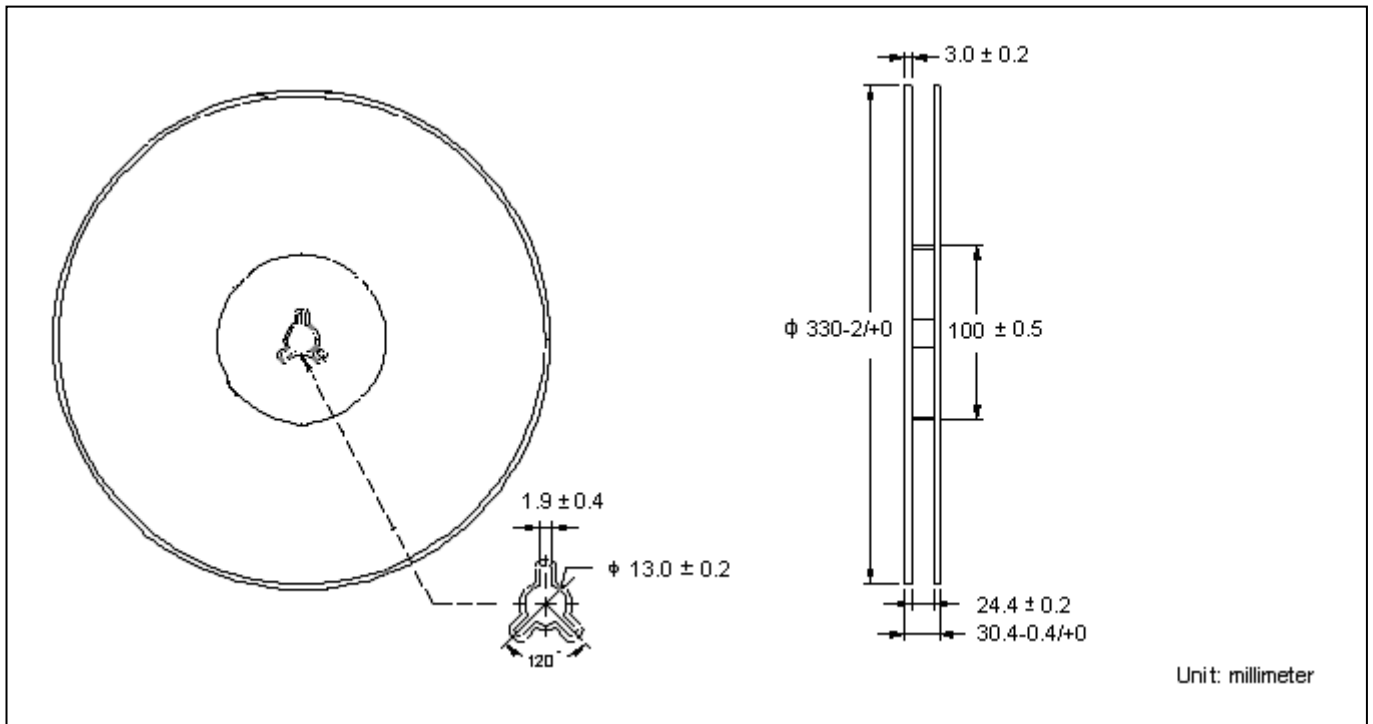

**Carrier Tape Dimension**

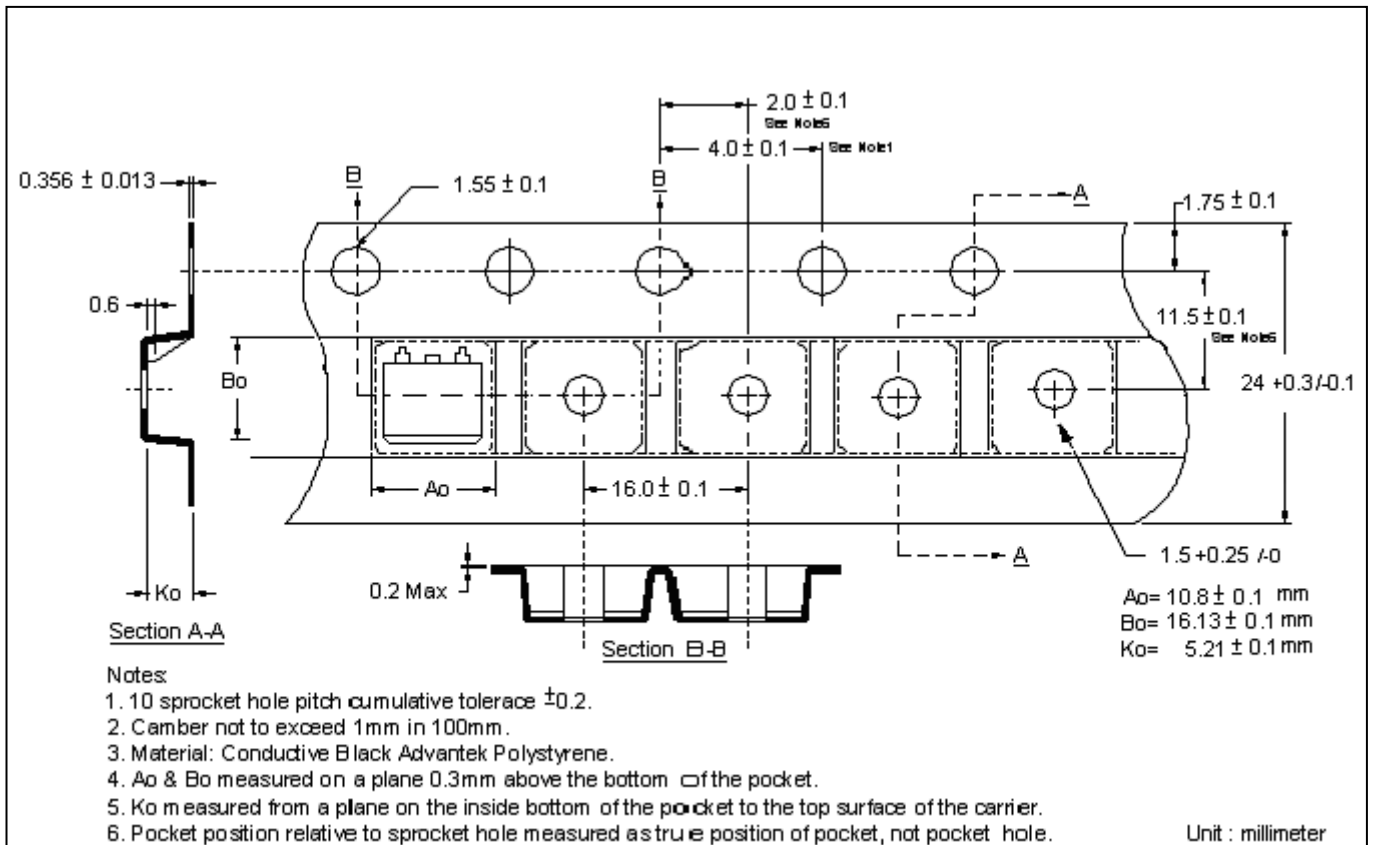

**Recommended wave soldering condition**

Product	Peak Temperature	Soldering Time
Pb-free devices	260 +0/-5 °C	5 +1/-1 seconds

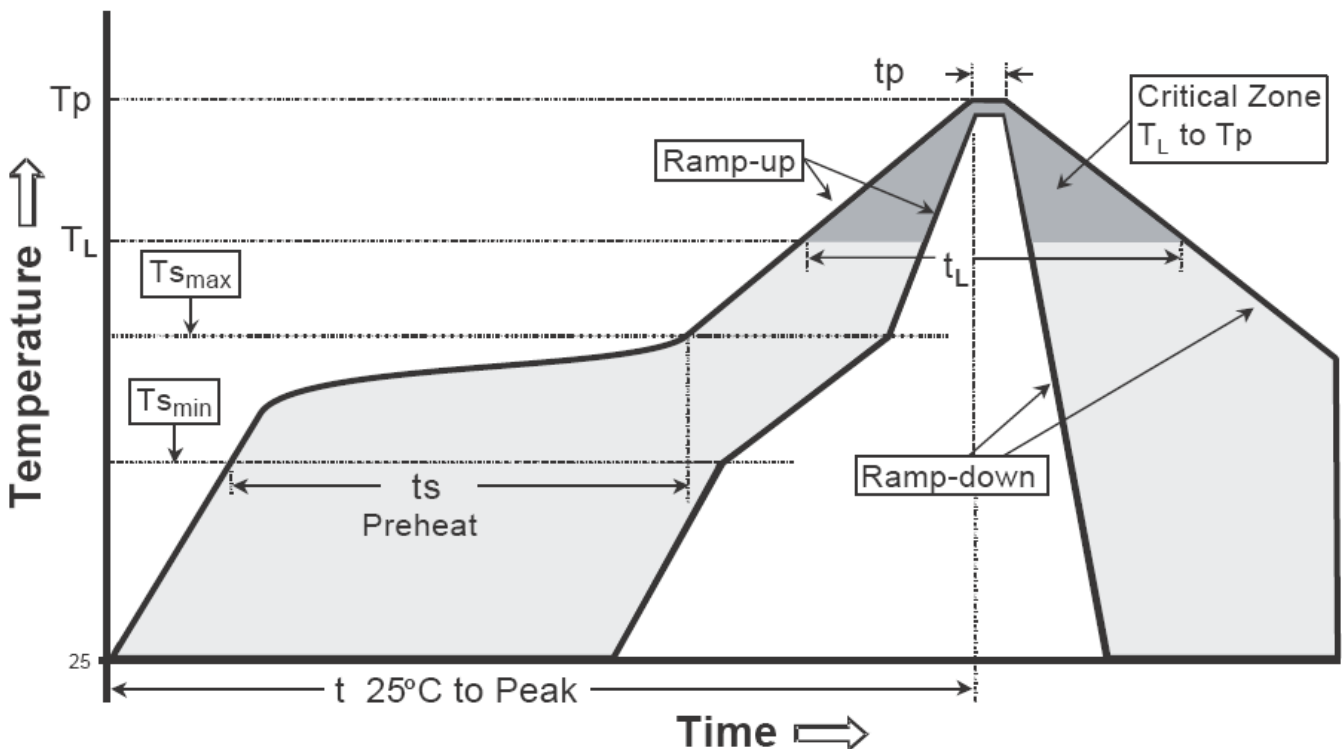
**Recommended temperature profile for IR reflow**

Profile feature	Sn-Pb eutectic Assembly	Pb-free Assembly
Average ramp-up rate (Tsmax to Tp)	3°C/second max.	3°C/second max.
Preheat		
-Temperature Min(Ts min)	100°C	150°C
-Temperature Max(Ts max)	150°C	200°C
-Time(ts min to ts max)	60-120 seconds	60-180 seconds
Time maintained above:		
-Temperature (TL)	183°C	217°C
- Time (tL)	60-150 seconds	60-150 seconds
Peak Temperature(Tp)	240 +0/-5 °C	260 +0/-5 °C
Time within 5°C of actual peak temperature(tp)	10-30 seconds	20-40 seconds
Ramp down rate	6°C/second max.	6°C/second max.
Time 25 °C to peak temperature	6 minutes max.	8 minutes max.

Note : All temperatures refer to topside of the package, measured on the package body surface.



**TO-263 Dimension**

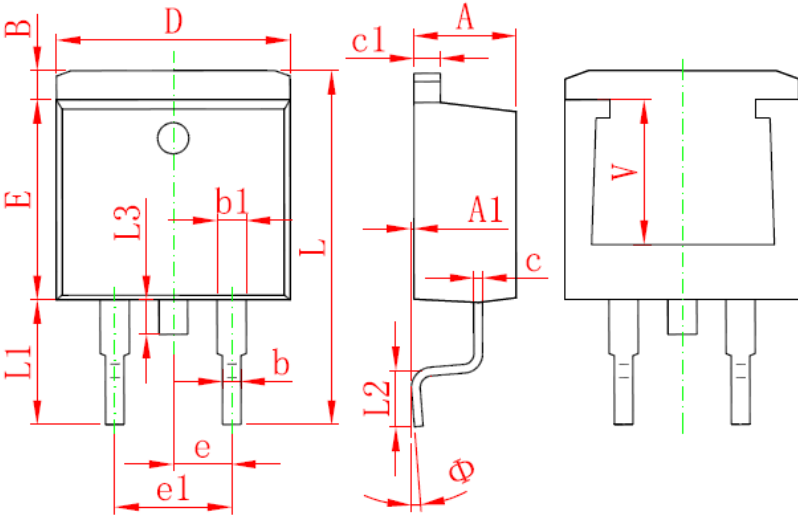

Marking :

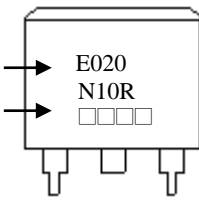

Device Name → E020  
N10R

Date Code → □□□□

Style : Pin 1.Gate 2.Drain  
3.Source

3-Lead Plastic Surface Mounted Package  
CYStek Package Code : F3

Date Code : (From left to right)  
 First Code : Year code, the last digit of Christnr year. For example, 2014→4, 2015→, 2016→6, ..., etc.  
 Second Code : Month code, Jan→A, Feb→B, Mar→C, Apr→D, May→E, Jun→F, Jul→G, Aug→H, Sep→J,  
 Oct→K, Nov→L, Dec→M  
 Third and fourth codes : production serial number, 01~99

DIM	Millimeters		Inches		DIM	Millimeters		Inches	
	Min.	Max.	Min.	Max.		Min.	Max.	Min.	Max.
A	4.470	4.670	0.176	0.184	e	2.540 TYP.		0.100 TYP	
A1	0.000	0.150	0.000	0.010	e1	4.980	5.180	0.196	0.204
B	1.120	1.420	0.044	0.056	L	14.940	15.500	0.588	0.610
b	0.710	0.910	0.028	0.036	L1	4.950	5.450	0.195	0.215
b1	1.170	1.370	0.046	0.054	L2	2.340	2.740	0.092	0.108
c	0.310	0.530	0.012	0.021	L3	1.300	1.700	0.051	0.067
c1	1.170	1.370	0.046	0.054	φ	0°	8°	0°	8°
D	10.010	10.310	0.394	0.406	V	6.400 REF		0.253 REF	
E	8.500	8.900	0.335	0.350					

Notes : 1.Controlling dimension : millimeters.  
 2.Maximum lead thickness includes lead finish thickness, and minimum lead thickness is the minimum thickness of base material.  
 3.If there is any question with packing specification or packing method, please contact your local CYStek sales office.

Material :

- Lead : Pure tin plated.
- Mold Compound : Epoxy resin family, flammability solid burning class:UL94V-0.

**Important Notice:**

- All rights are reserved. Reproduction in whole or in part is prohibited without the prior written approval of CYStek.
- CYStek reserves the right to make changes to its products without notice.
- CYStek **semiconductor products are not warranted to be suitable for use in Life-Support Applications, or systems.**
- CYStek assumes no liability for any consequence of customer product design, infringement of patents, or application assistance.