

Dual N-Channel Enhancement Mode Power MOSFET

MTE020A10RH8

BV_{DSS}	100V
I_D@V_{GS}=10V, T_C=25°C	29.3A
I_D@V_{GS}=10V, T_C=100°C	18.5A
I_D@V_{GS}=10V, T_A=25°C	5.1A
I_D@V_{GS}=10V, T_A=70°C	4.1A
R_{DS(ON)}@V_{GS}=10V, I_D=20A	26mΩ (typ)

Features

- Low On Resistance
- Simple Drive Requirement
- Low Gate Charge
- Fast Switching Characteristic
- Pb-free lead plating and Halogen-free package

Equivalent Circuit

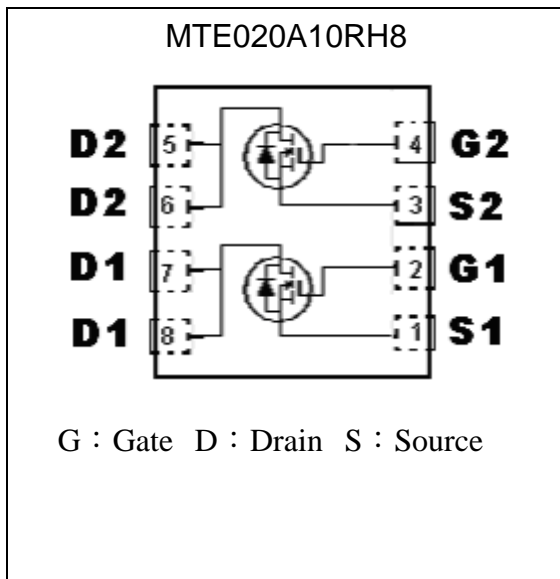

Outline

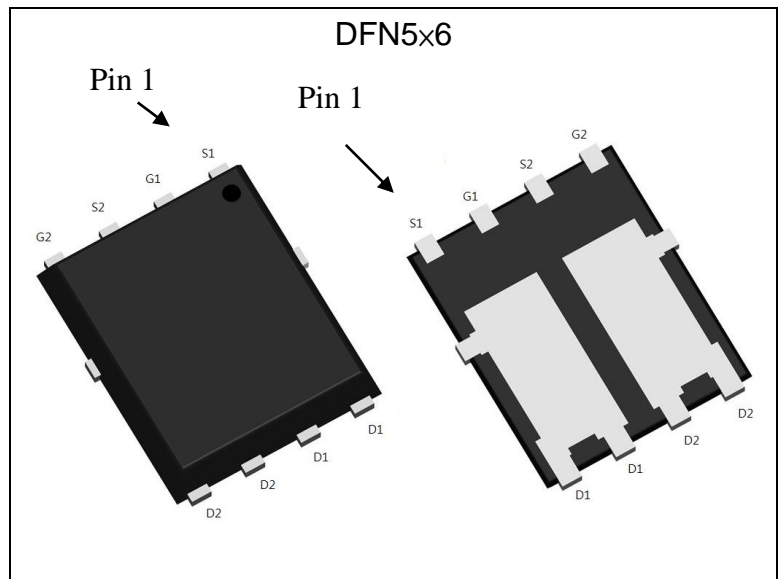

Ordering Information

Device	Package	Shipping
MTE020A10RH8-0-T6-G	DFN 5 x 6 (Pb-free lead plating and halogen-free package)	3000 pcs / tape & reel

- ↑ Environment friendly grade : S for RoHS compliant products, G for RoHS compliant and green compound products
- ↑ Packing spec, T6 : 3000 pcs / tape & reel, 13" reel
- ↑ Product rank, zero for no rank products
- ↑ Product name



Absolute Maximum Ratings ($T_C=25^{\circ}\text{C}$, unless otherwise noted)

Parameter	Symbol	Limits	Unit	
Drain-Source Voltage	V_{DS}	100	V	
Gate-Source Voltage	V_{GS}	± 20		
Continuous Drain Current @ $T_C=25^{\circ}\text{C}$, $V_{GS}=10\text{V}$ (Note 1)	I_D	29.3	A	
Continuous Drain Current @ $T_C=100^{\circ}\text{C}$, $V_{GS}=10\text{V}$ (Note 1)		18.5		
Continuous Drain Current @ $T_A=25^{\circ}\text{C}$, $V_{GS}=10\text{V}$ (Note 2)	I_{DSM}	5.1		
Continuous Drain Current @ $T_A=70^{\circ}\text{C}$, $V_{GS}=10\text{V}$ (Note 2)		4.1		
Pulsed Drain Current @ $V_{GS}=10\text{V}$ (Note 3)	I_{DM}	80		
Avalanche Current @ $L=0.1\text{mH}$ (Note 3)	I_{AS}	22		
Single Pulse Avalanche Energy @ $L=0.5\text{mH}$, $I_D=14\text{Amps}$, $V_{DD}=25\text{V}$ (Note 5)	E_{AS}	49	mJ	
Repetitive Avalanche Energy (Note 3)	E_{AR}	5		
Power Dissipation	P_D	$T_C=25^{\circ}\text{C}$ (Note 1)	56	W
		$T_C=100^{\circ}\text{C}$ (Note 1)	22	
	P_{DSM}	$T_A=25^{\circ}\text{C}$ (Note 2)	1.7	
		$T_A=70^{\circ}\text{C}$ (Note 2)	1.1	
Operating Junction and Storage Temperature	T_j, T_{stg}	-55~+150	$^{\circ}\text{C}$	

*Drain current limited by maximum junction temperature

Thermal Data

Parameter	Symbol	Value	Unit
Thermal Resistance, Junction-to-case, max	$R_{\theta JC}$	2.2	$^{\circ}\text{C}/\text{W}$
Thermal Resistance, Junction-to-ambient, max (Note 4)	$R_{\theta JA}$	72	

- Note : 1. The power dissipation P_D is based on $T_{J(MAX)}=150^{\circ}\text{C}$, using junction-to-case thermal resistance, and is more useful in setting the upper dissipation limit for cases where additional heatsinking is used.
2. The value of $R_{\theta JA}$ is measured with the device mounted on 1 in² FR-4 board with 2 oz. copper, in a still air environment with $T_A=25^{\circ}\text{C}$. The value in any given application depends on the user's specific board design. The power dissipation P_{DSM} is based on $R_{\theta JA}$ and the maximum allowed junction temperature of 150°C .
3. Ratings are based on low frequency and low duty cycles to keep initial $T_J=25^{\circ}\text{C}$.
4. When mounted on 1 in² copper pad of FR-4 board ; $125^{\circ}\text{C}/\text{W}$ when mounted on minimum copper pad.
5. 100% tested by conditions of $L=0.5\text{mH}$, $I_{AS}=10\text{A}$, $V_{GS}=10\text{V}$, $V_{DD}=25\text{V}$.

Characteristics ($T_J=25^{\circ}\text{C}$, unless otherwise specified)

Symbol	Min.	Typ.	Max.	Unit	Test Conditions
Static					
BV_{DSS}	100	-	-	V	$V_{GS}=0\text{V}$, $I_D=250\mu\text{A}$
$\Delta BV_{DSS}/\Delta T_j$	-	0.1	-	$\text{V}/^{\circ}\text{C}$	Reference to 25°C , $I_D=250\mu\text{A}$
$V_{GS(th)}$	2	-	4	V	$V_{DS} = V_{GS}$, $I_D=250\mu\text{A}$
* G_{FS}	-	5.7	-	S	$V_{DS} = 10\text{V}$, $I_D=5\text{A}$
I_{GSS}	-	-	± 100	nA	$V_{GS}=\pm 20\text{V}$, $V_{DS}=0\text{V}$
I_{DSS}	-	-	1	μA	$V_{DS} = 100\text{V}$, $V_{GS} = 0\text{V}$
	-	-	25		$V_{DS} = 80\text{V}$, $V_{GS} = 0\text{V}$, $T_j=85^{\circ}\text{C}$

*R _{DS(ON)}	-	26	36	mΩ	V _{GS} =10V, I _D =20A
Dynamic					
*Q _g	-	13.6	-	nC	V _{DS} =50V, I _D =20A, V _{GS} =10V
*Q _{gs}	-	5.9	-		
*Q _{gd}	-	2.9	-		
*t _{d(ON)}	-	12.8	-	ns	V _{DS} =50V, I _D =20A, V _{GS} =10V, R _G =1Ω
*t _r	-	15	-		
*t _{d(OFF)}	-	19.6	-		
*t _f	-	6.6	-		
C _{iss}	-	877	-	pF	V _{GS} =0V, V _{DS} =50V, f=1MHz
C _{oss}	-	108	-		
C _{rss}	-	25	-		
R _g	-	1.5	-	Ω	f=1MHz
Source-Drain Diode					
*I _S	-	-	29.3	A	
*I _{SM}	-	-	80		
*V _{SD}	-	0.76	1	V	I _S =1A, V _{GS} =0V
*t _{rr}	-	24.4	-	ns	V _{GS} =0V, I _F =1A, dI _F /dt=100A/μs
*Q _{rr}	-	22.2	-	nC	

*Pulse Test : Pulse Width ≤300μs, Duty Cycle≤2%

Recommended Soldering Footprint

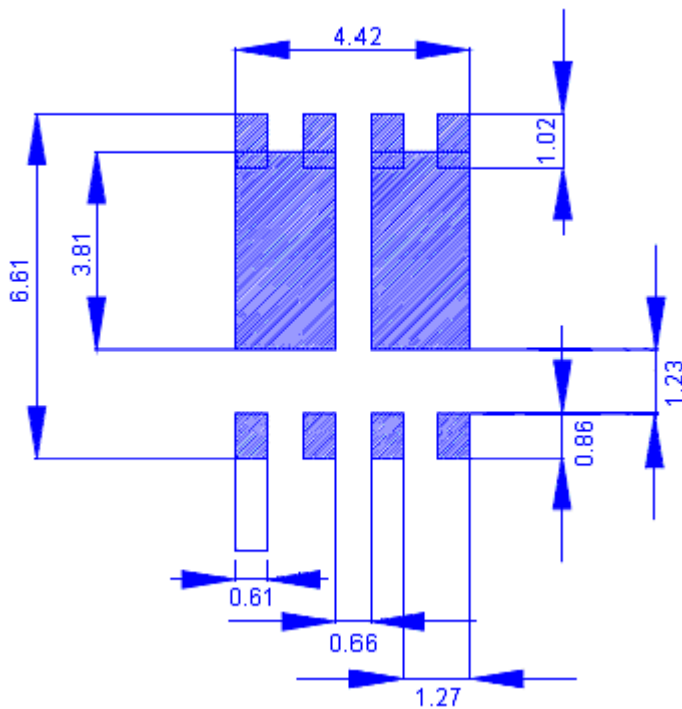

unit : mm

Recommended Stencil Design

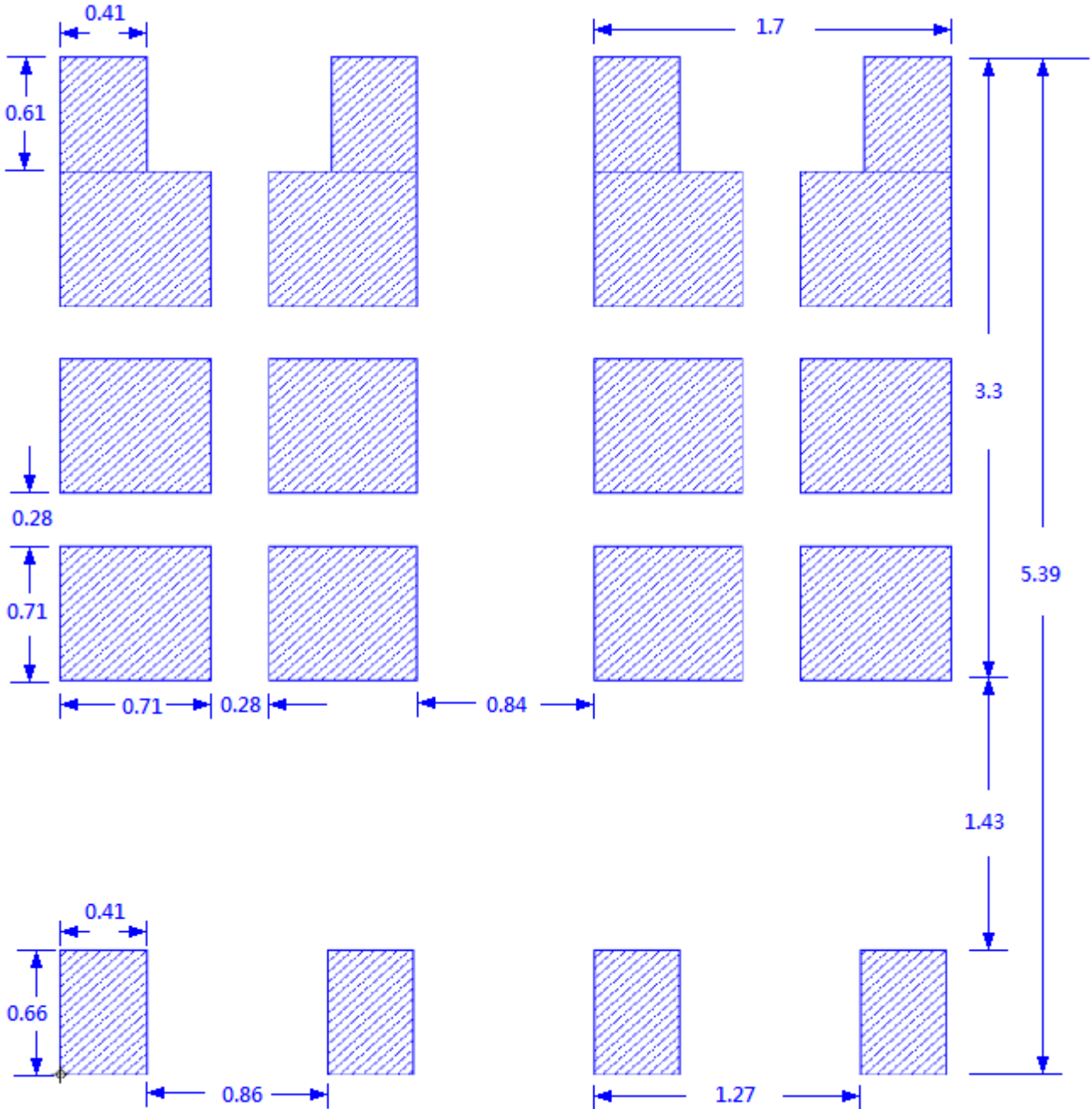

unit : mm

- Note :**
1. Stencil thickness 5 mil (0.127mm)
 2. May need to be adjusted to specific requirements.

Typical Characteristics

Typical Output Characteristics

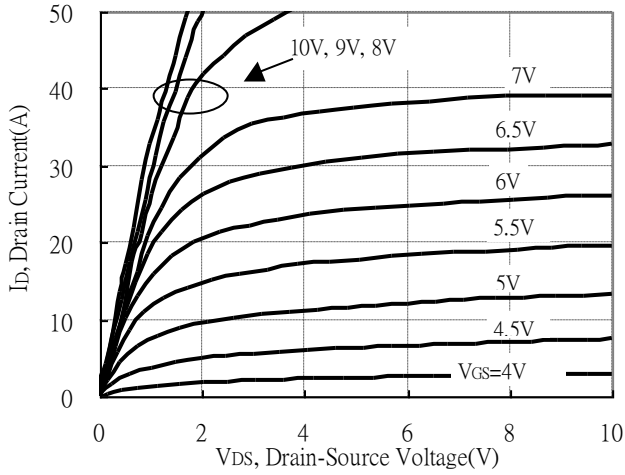

Brekdown Voltage vs Ambient Temperature

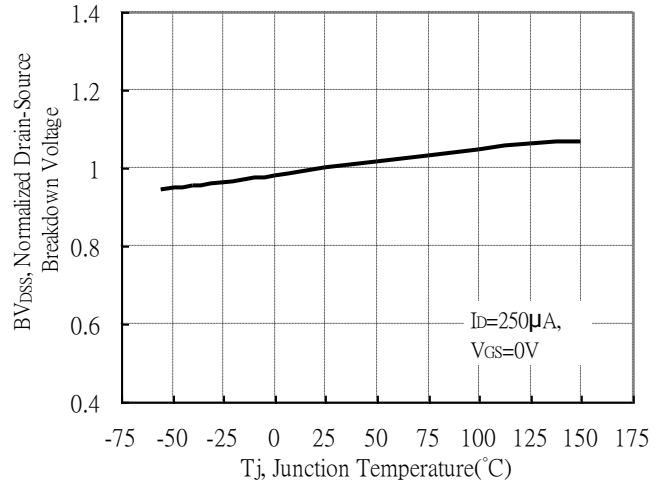

Static Drain-Source On-State resistance vs Drain Current

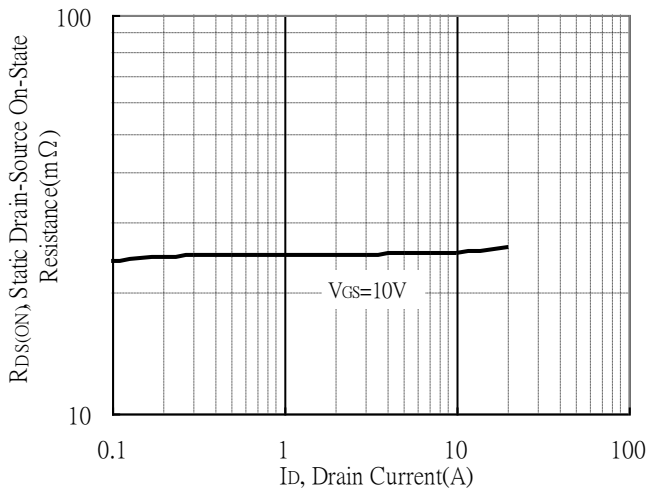

Reverse Drain Current vs Source-Drain Voltage

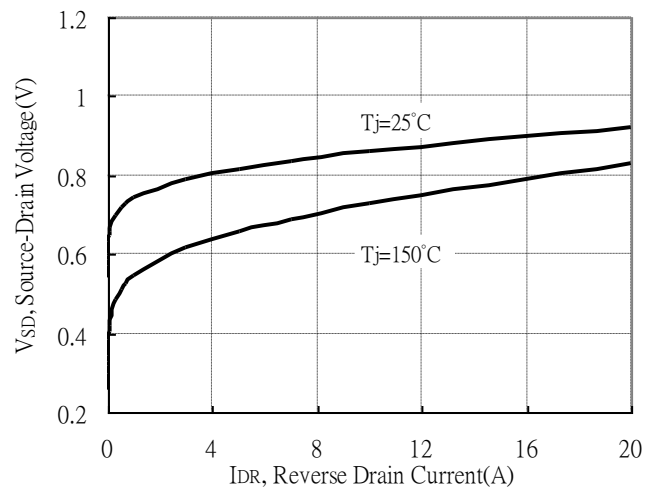

Static Drain-Source On-State Resistance vs Gate-Source Voltage

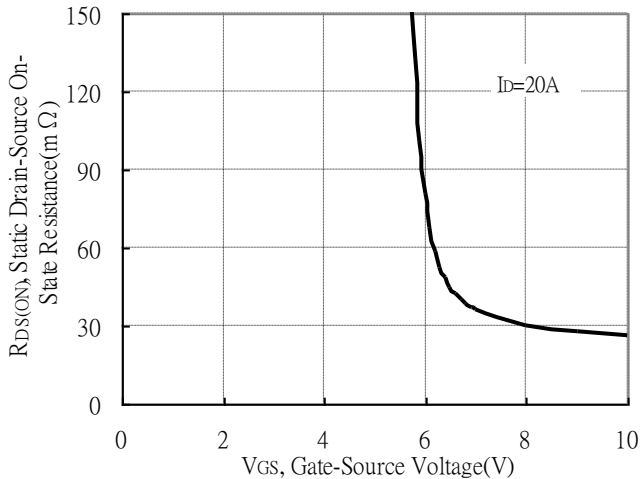

Drain-Source On-State Resistance vs Junction Temperature

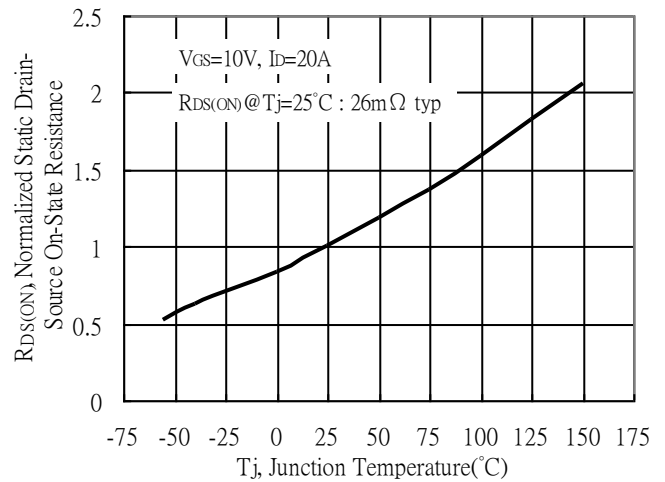

Typical Characteristics(Cont.)

Capacitance vs Drain-to-Source Voltage

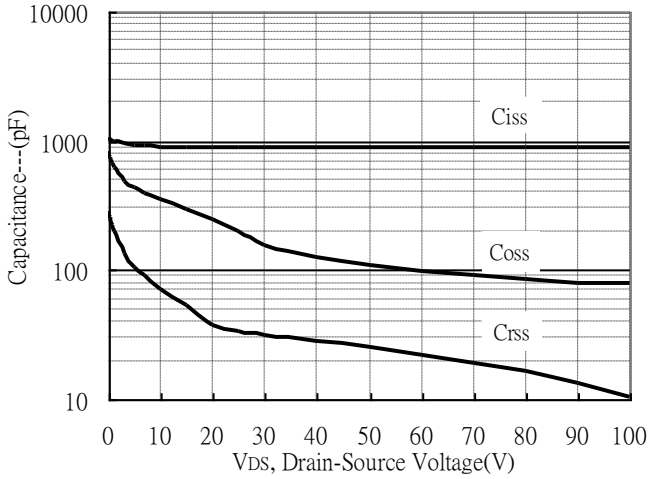

Normalized Threshold Voltage vs Junction Temperature

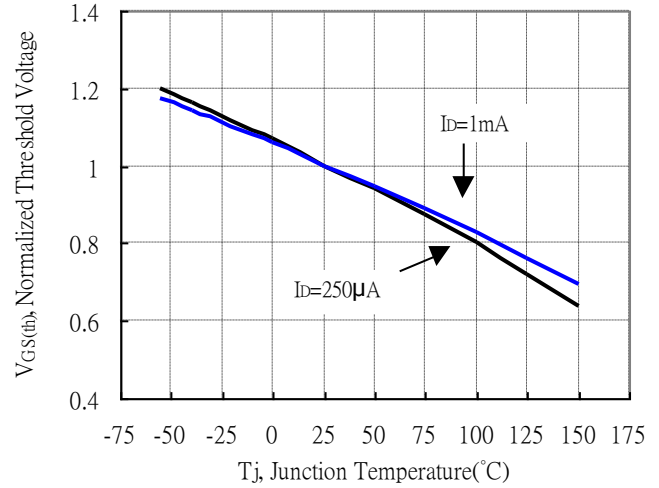

Forward Transfer Admittance vs Drain Current

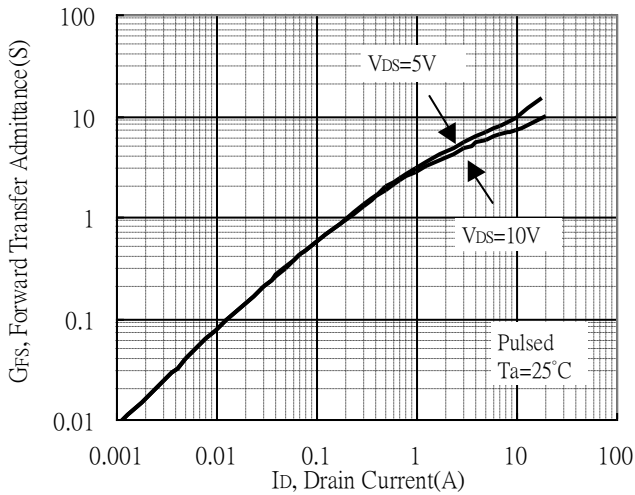

Gate Charge Characteristics

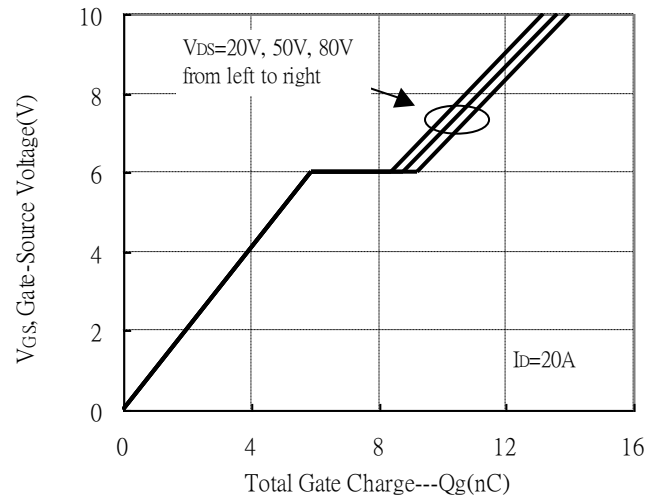

Maximum Safe Operating Area

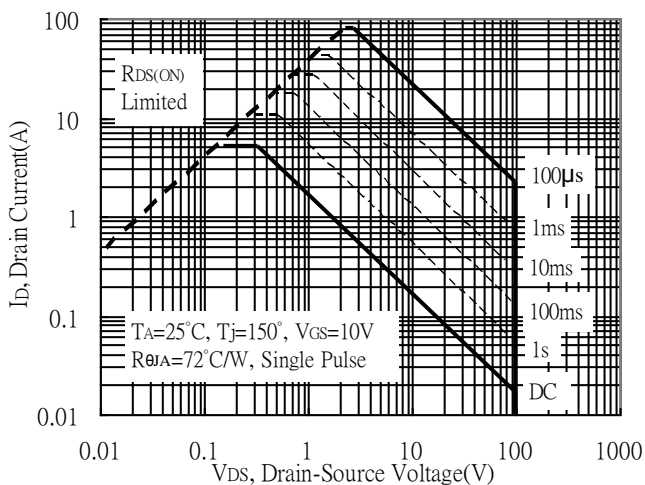

Maximum Drain Current vs Junction Temperature

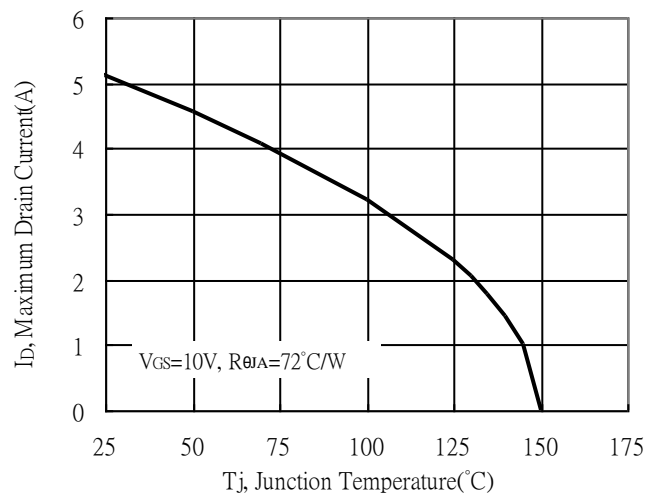

Typical Characteristics(Cont.)

Typical Transfer Characteristics

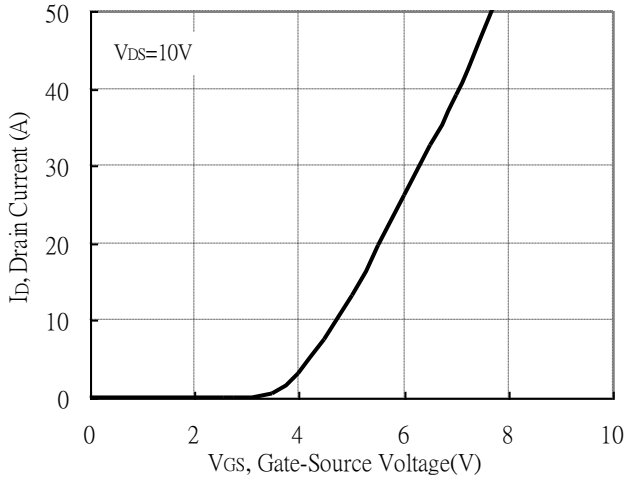

Single Pulse Maximum Power Dissipation

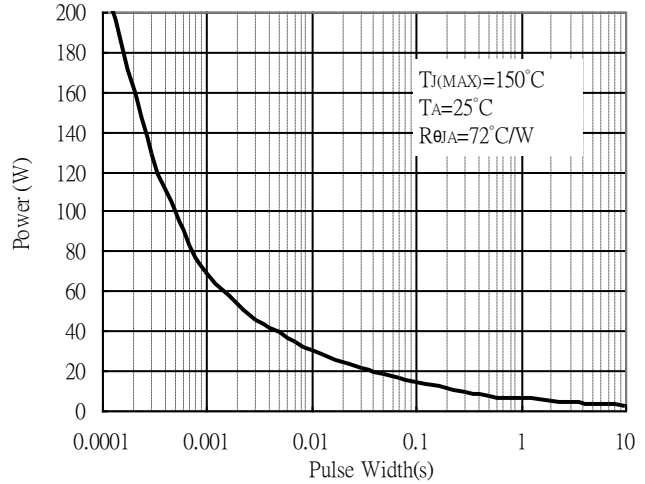

Maximum Safe Operating Area

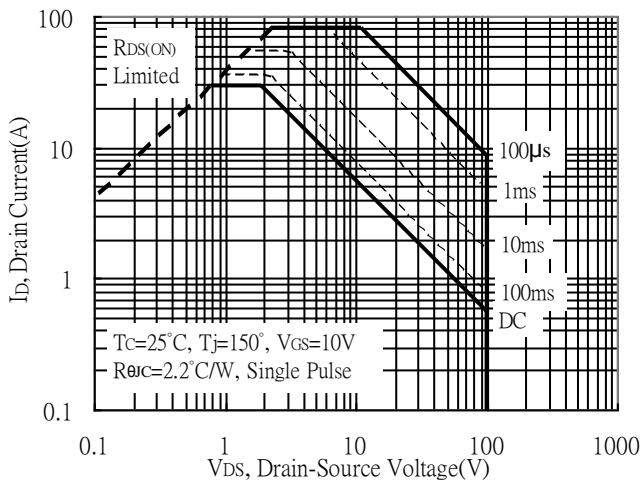

Maximum Drain Current vs Case Temperature

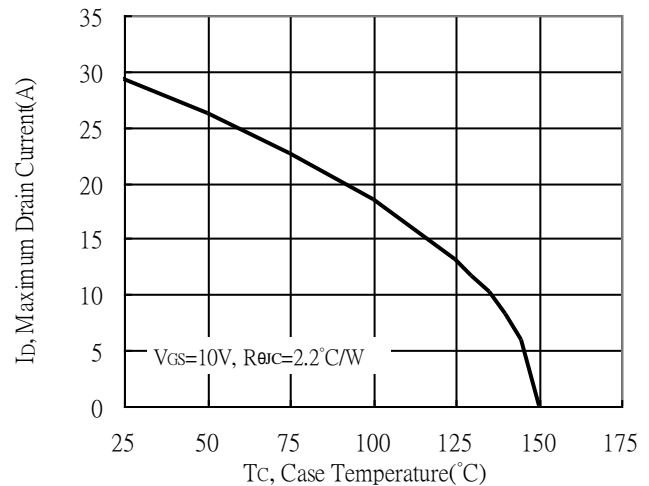

Single Pulse Maximum Power Dissipation

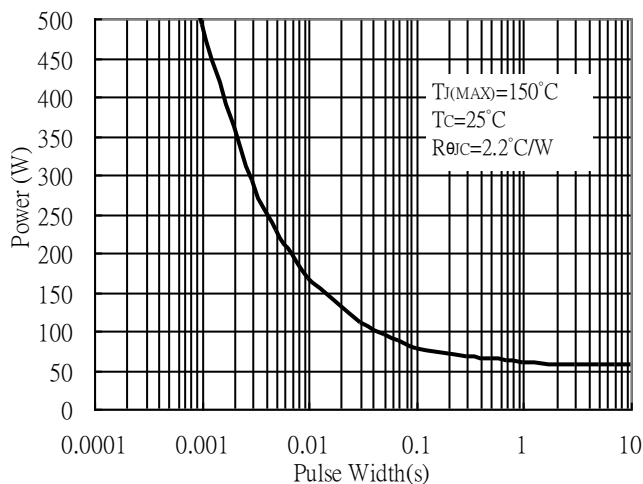

Power Derating Curve

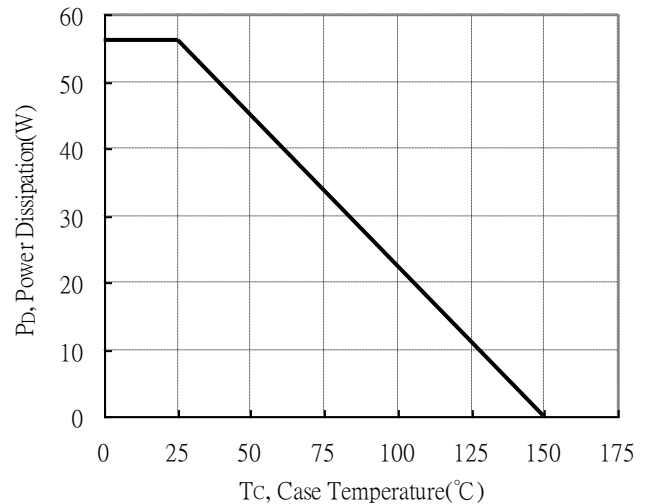

Typical Characteristics(Cont.)

Transient Thermal Response Curves

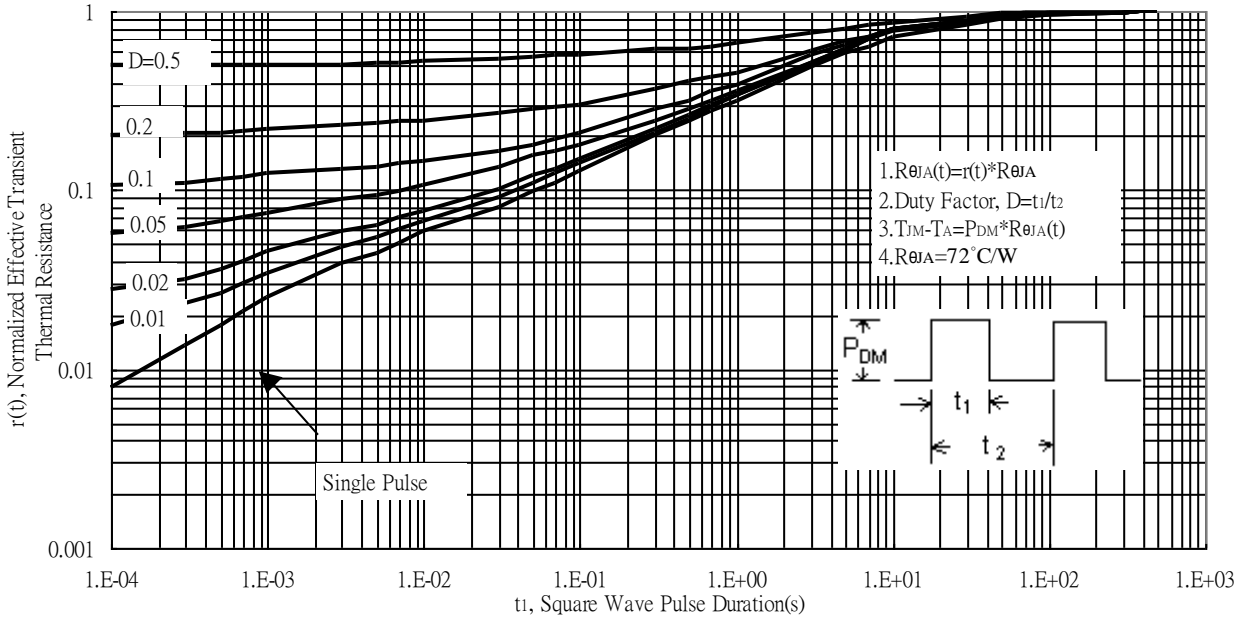

Transient Thermal Response Curves

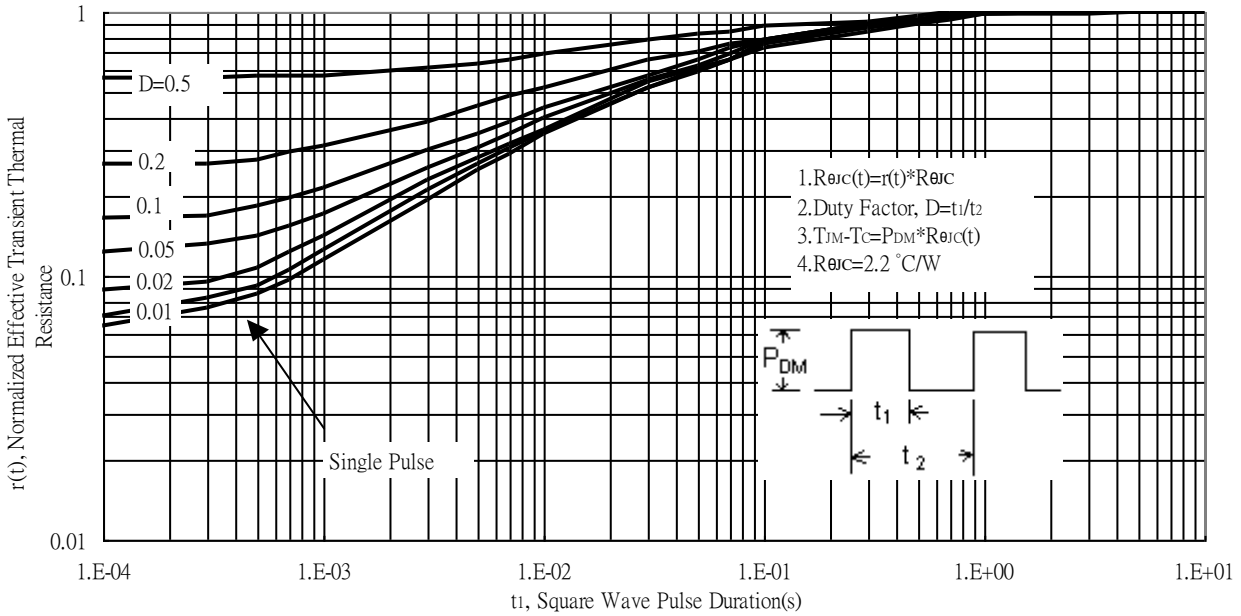

Reel Dimension

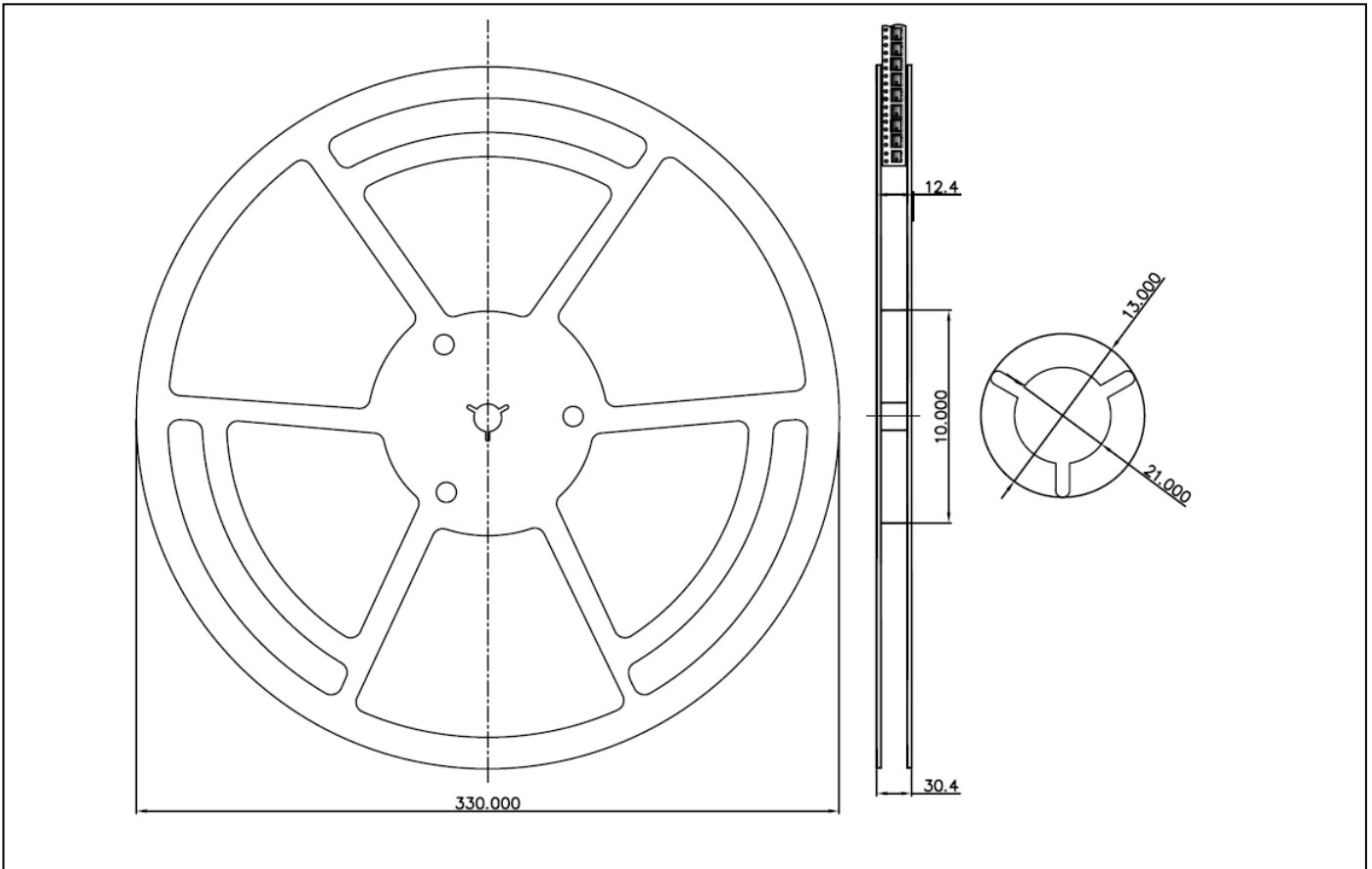

Carrier Tape Dimension

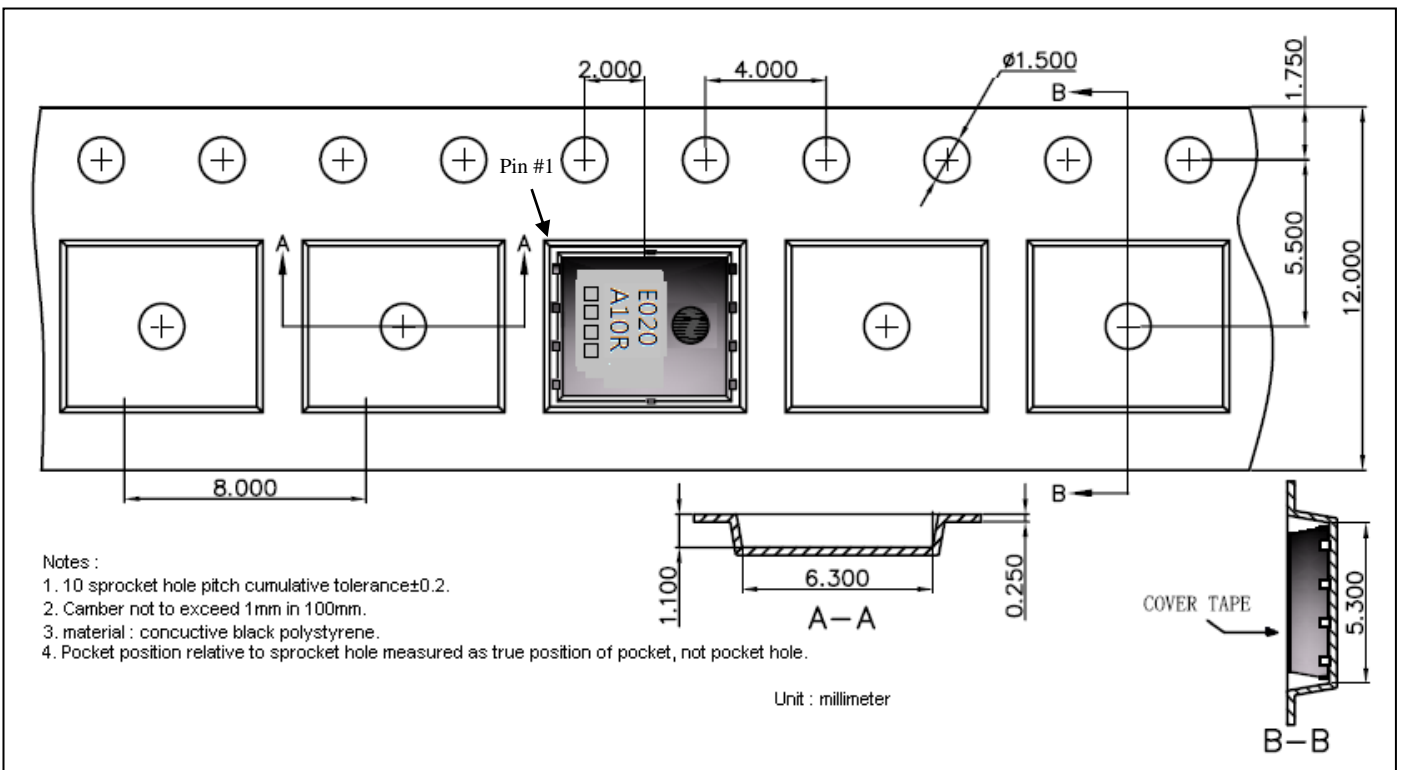

Recommended wave soldering condition

Product	Peak Temperature	Soldering Time
Pb-free devices	260 +0/-5 °C	5 +1/-1 seconds

Recommended temperature profile for IR reflow

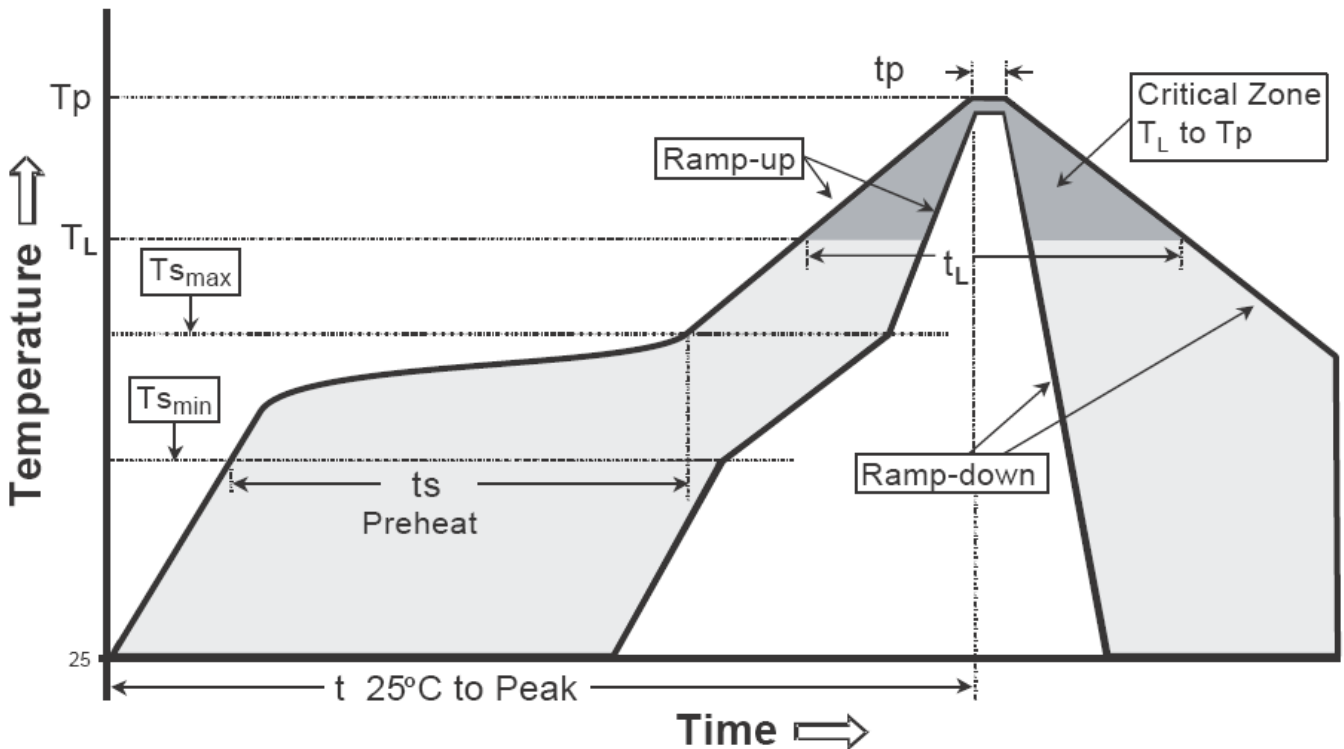

Profile feature	Sn-Pb eutectic Assembly	Pb-free Assembly
Average ramp-up rate (T _{smax} to T _p)	3°C/second max.	3°C/second max.
Preheat		
-Temperature Min(T _{s min})	100°C	150°C
-Temperature Max(T _{s max})	150°C	200°C
-Time(t _{s min} to t _{s max})	60-120 seconds	60-180 seconds
Time maintained above:		
-Temperature (T _L)	183°C	217°C
- Time (t _L)	60-150 seconds	60-150 seconds
Peak Temperature(T _p)	240 +0/-5 °C	260 +0/-5 °C
Time within 5°C of actual peak temperature(tp)	10-30 seconds	20-40 seconds
Ramp down rate	6°C/second max.	6°C/second max.
Time 25 °C to peak temperature	6 minutes max.	8 minutes max.

Note :1. All temperatures refer to topside of the package, measured on the package body surface.
 2.For devices mounted on FR-4 PCB of 1.6mm or equivalent grade PCB. If other grade PCB is used, care should be taken to match the coefficients of thermal expansion between components and PCB. If they are not matched well, the solder joints may crack or the bodies of the parts may crack or shatter as the assembly cools.

DFN5x6 Dimension

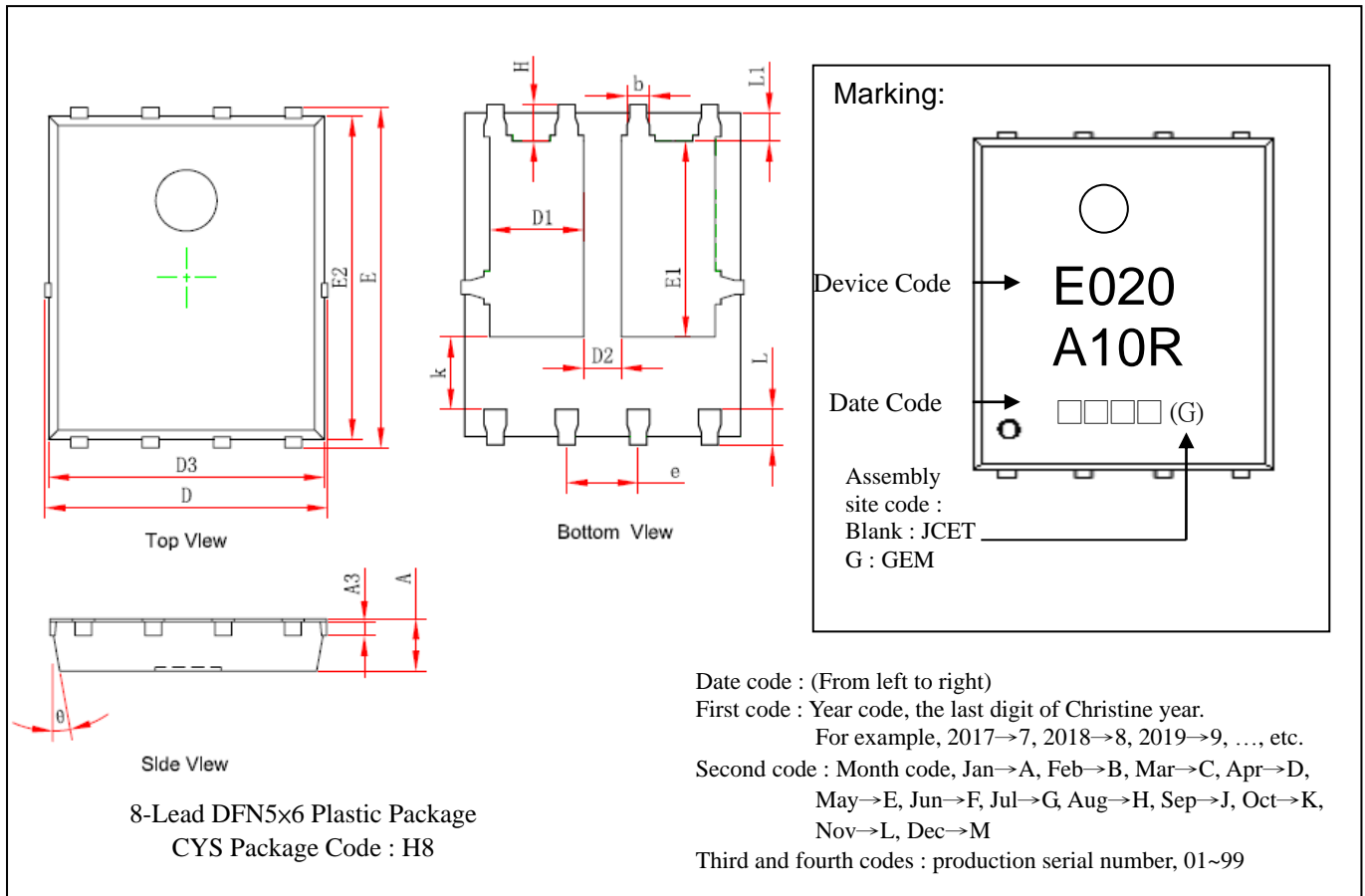

Marking:

Device Code → **E020**
 A10R

Date Code → □□□□ (G)

Assembly site code :
 Blank : JCET
 G : GEM

Date code : (From left to right)
 First code : Year code, the last digit of Christine year.
 For example, 2017→7, 2018→8, 2019→9, ..., etc.
 Second code : Month code, Jan→A, Feb→B, Mar→C, Apr→D,
 May→E, Jun→F, Jul→G, Aug→H, Sep→J, Oct→K,
 Nov→L, Dec→M
 Third and fourth codes : production serial number, 01~99

8-Lead DFN5x6 Plastic Package
 CYS Package Code : H8

DIM	Millimeters		Inches		DIM	Millimeters		Inches	
	Min.	Max.	Min.	Max.		Min.	Max.	Min.	Max.
A	0.900	1.000	0.035	0.039	E2	5.674	5.826	0.223	0.229
A3	0.254	REF	0.010	REF	k	1.190	1.390	0.047	0.055
D	4.944	5.096	0.195	0.201	b	0.350	0.450	0.014	0.018
E	5.974	6.126	0.235	0.241	e	1.270	TYP	0.050	TYP
D1	1.470	1.870	0.058	0.074	L	0.559	0.711	0.022	0.028
D2	0.470	0.870	0.019	0.034	L1	0.424	0.576	0.017	0.023
E1	3.375	3.575	0.133	0.141	H	0.574	0.726	0.023	0.029
D3	4.824	4.976	0.190	0.196	θ	10°	12°	10°	12°

Notes: 1.Controlling dimension: millimeters.
 2.Maximum lead thickness includes lead finish thickness, and minimum lead thickness is the minimum thickness of base material.
 3.If there is any question with packing specification or packing method, please contact your local CYStek sales office.

Material:

- Lead: Pure tin plated.
- Mold Compound: Epoxy resin family, flammability solid burning class: UL94V-0.

Important Notice:

- All rights are reserved. Reproduction in whole or in part is prohibited without the prior written approval of CYStek.
- CYStek reserves the right to make changes to its products without notice.
- CYStek **semiconductor products are not warranted to be suitable for use in Life-Support Applications, or systems.**
- CYStek assumes no liability for any consequence of customer product design, infringement of patents, or application assistance.