

## Product Summary

$BV_{DSS}$	100	V
$R_{DS(ON)}$ typ. @ $V_{GS}=10V, I_D=10A$	14.5	m $\Omega$
$I_D$ @ $V_{GS}=10V, T_C=25^\circ C$	45	A
$I_D$ @ $V_{GS}=10V, T_A=25^\circ C$	9	

## DFN5x6

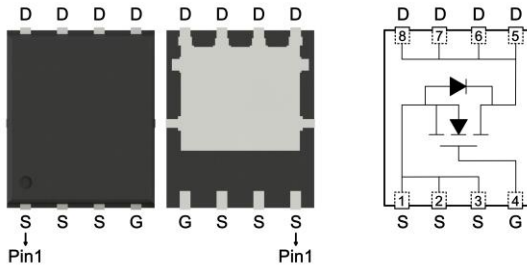

## Features

- Low Gate Charge
- Fast Switching Characteristic
- Pb-free lead plating and halogen-free

## Marking

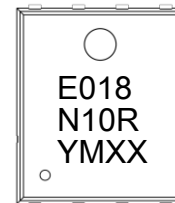

← Device Code

← Date Code

YMXX: Date Code Marking

Y: Year Code, the last digit of Christian year

M: Month Code

A: Jan	B: Feb	C: Mar	D: Apr	E: May	F: Jun
G: Jul	H: Aug	J: Sep	K: Oct	L: Nov	M: Dec

XX: Production Serial Number, 01~99

## Ordering Information

Device	Package	Shipping
MTE018N10RH8-0-T6-G	DFN5x6	3000pcs / Tape & Reel

0: Product rank, zero for no rank products.

T6: Packing spec, T6 : 3000pcs / tape & reel, 13" reel

G: Environment friendly grade: S for RoHS compliant products, G for RoHS compliant and green compound products.

## Absolute Maximum Ratings ( $T_A=25^\circ C$ )

Parameter	Symbol	Value	Unit	
Drain-Source Voltage	$V_{DS}$	100	V	
Gate-Source Voltage	$V_{GS}$	$\pm 20$		
Continuous Drain Current @ $V_{GS}=10V, T_C=25^\circ C$	$I_D$	45	A	
Continuous Drain Current @ $V_{GS}=10V, T_C=100^\circ C$		28		
Continuous Drain Current @ $V_{GS}=10V, T_A=25^\circ C$		9		
Continuous Drain Current @ $V_{GS}=10V, T_A=70^\circ C$		7.2		
Pulsed Drain Current	$I_{DM}$	120		
Continuous Body Diode Forward Current @ $T_C=25^\circ C$	$I_S$	45		
Pulsed Body Diode Forward Current @ $T_C=25^\circ C$	$I_{SM}$	120		
Avalanche Current @ $L=0.1mH$	$I_{AS}$	10		
Avalanche Energy @ $L=0.5mH$	$E_{AS}$	25	mJ	
Total Power Dissipation	$P_D$	$T_C=25^\circ C$	69	W
		$T_C=100^\circ C$	28	
		$T_A=25^\circ C$	2.8	
		$T_A=70^\circ C$	1.8	
Operating Junction and Storage Temperature Range	$T_J, T_{stg}$	-55~+150	$^\circ C$	
Steady State Thermal Resistance, Junction-to-Case	$R_{\theta JC}$	1.8	$^\circ C/W$	
Steady State Thermal Resistance, Junction-to-Ambient	$R_{\theta JA}$	45		



**Electrical Characteristics (T<sub>A</sub>=25°C, unless otherwise specified)**

Symbol	Min.	Typ.	Max.	Unit	Test Conditions
<b>Static</b>					
BV <sub>DSS</sub>	100	-	-	V	V <sub>GS</sub> =0V, I <sub>D</sub> =250μA
V <sub>GS(th)</sub>	2	-	4		V <sub>DS</sub> =V <sub>GS</sub> , I <sub>D</sub> =250μA
G <sub>FS</sub>	-	8.5	-	S	V <sub>DS</sub> =10V, I <sub>D</sub> =10A
I <sub>GSS</sub>	-	-	±100	nA	V <sub>GS</sub> =±20V, V <sub>DS</sub> =0V
I <sub>DSS</sub>	-	-	1	μA	V <sub>DS</sub> =80V, V <sub>GS</sub> =0V
R <sub>DS(ON)</sub>	-	14.5	18.5	mΩ	V <sub>GS</sub> =10V, I <sub>D</sub> =10A
<b>Dynamic</b>					
C <sub>iss</sub>	-	1289	-	pF	V <sub>DS</sub> =50V, V <sub>GS</sub> =0V, f=1MHz
C <sub>oss</sub>	-	171	-		
C <sub>rss</sub>	-	30	-		
R <sub>g</sub>	-	1.4	-	Ω	f=1MHz
Q <sub>g</sub> *d,e	-	21	-	nC	V <sub>DS</sub> =50V, I <sub>D</sub> =10A, V <sub>GS</sub> =10V
Q <sub>gs</sub> *d,e	-	8	-		
Q <sub>gd</sub> *d,e	-	4.5	-		
t <sub>d(ON)</sub> *d,e	-	18	-	ns	V <sub>DS</sub> =50V, I <sub>D</sub> =10A, V <sub>GS</sub> =10V, R <sub>GS</sub> =1Ω
tr *d,e	-	17	-		
t <sub>d(OFF)</sub> *d,e	-	27	-		
t <sub>f</sub> *d,e	-	8	-		
<b>Source-Drain Diode</b>					
V <sub>SD</sub> *d	-	0.84	1.2	V	I <sub>S</sub> =10A, V <sub>GS</sub> =0V
t <sub>rr</sub>	-	30	-	ns	I <sub>F</sub> =10A, di/dt=100A/μs
Q <sub>rr</sub>	-	37	-	nC	

**Note:**

- \*a. The power dissipation P<sub>D</sub> is based on T<sub>J(MAX)</sub>=150°C, using junction-to-case thermal resistance, and is more useful in setting the upper Dissipation.
- \*b. The value of R<sub>θJA</sub> is measured with the device mounted on 1in<sup>2</sup> FR-4 board with 2oz copper, in a still air environment with T<sub>A</sub>=25°C. The power dissipation P<sub>D</sub> is based on R<sub>θJA</sub> and the maximum allowed junction temperature of 150°C. The value in any given application depends on the user's specific board design.
- \*c. Repetitive rating, pulse width limited by junction temperature T<sub>J(MAX)</sub>=150°C. Ratings are based on low frequency and low duty cycles to keep initial T<sub>J</sub>=25°C.
- \*d. Pulse Test : Pulse Width≤300μs, Duty Cycle≤2%.
- \*e. Independent of operating temperature.

## Typical Characteristics

Typical Output Characteristics

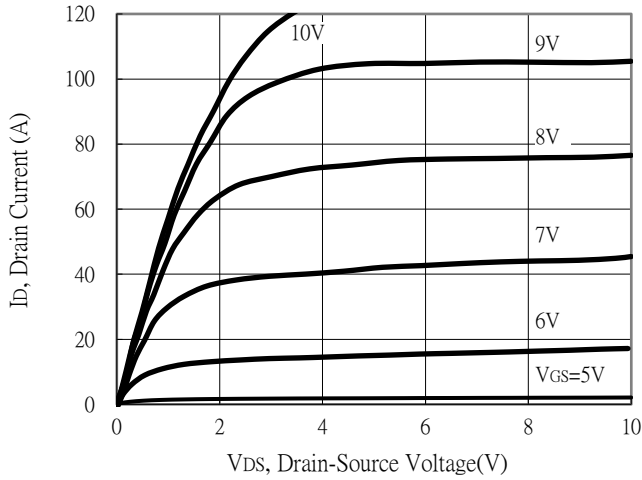

Breakdown Voltage vs Ambient Temperature

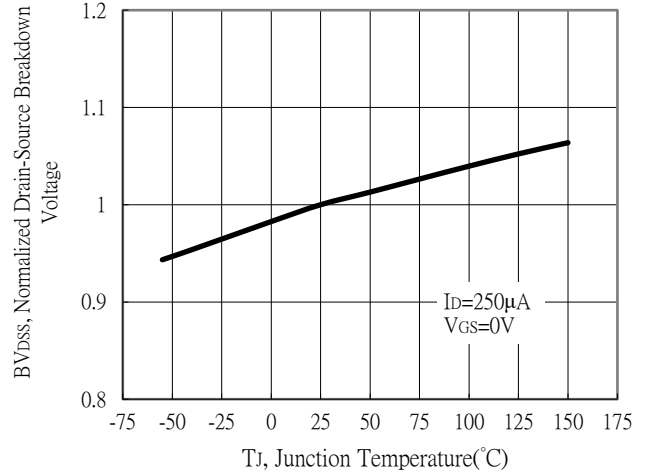

Static Drain-Source On-State resistance vs Drain Current

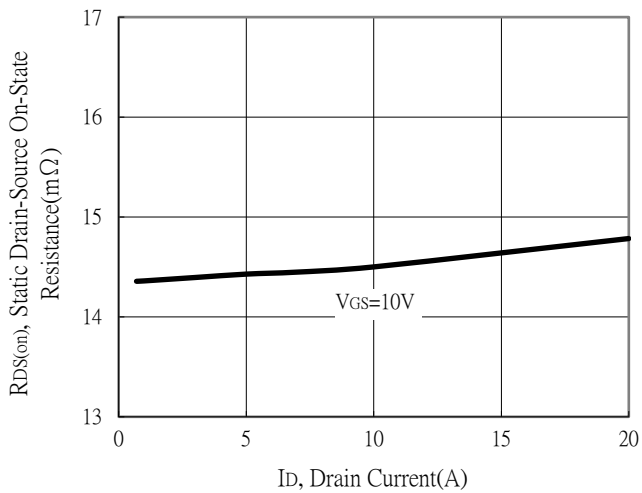

Body Diode Current vs Source-Drain Voltage

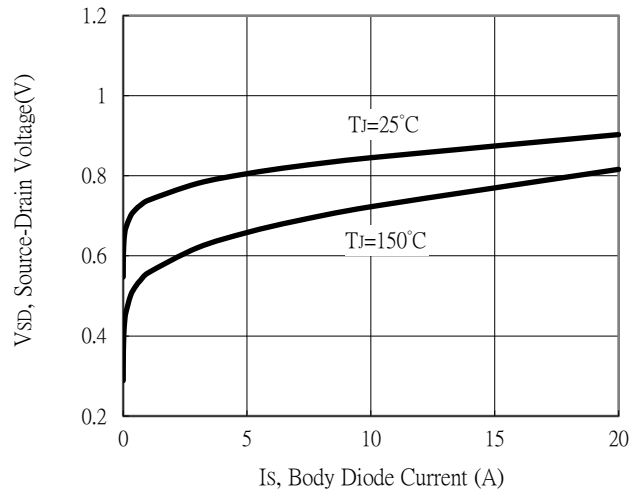

Static Drain-Source On-State Resistance vs Gate-Source Voltage

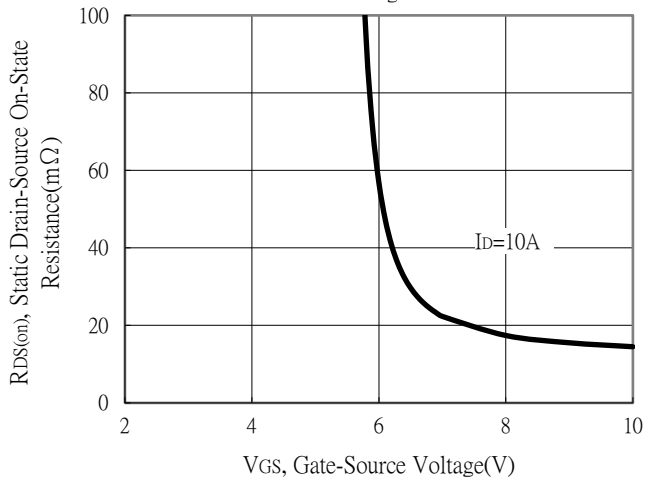

Drain-Source On-State Resistance vs Junction Temperature

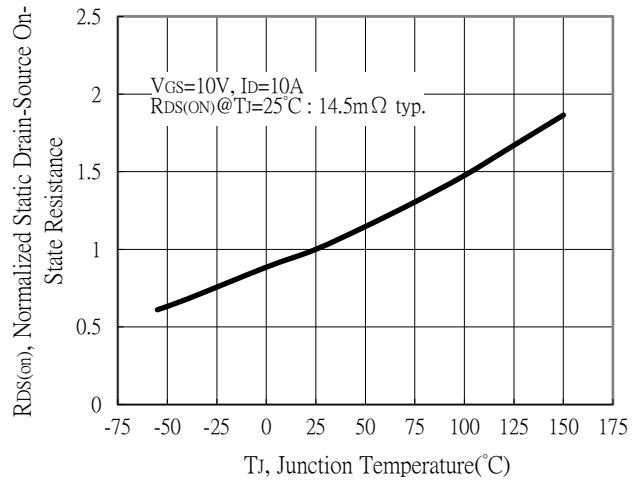

## Typical Characteristics

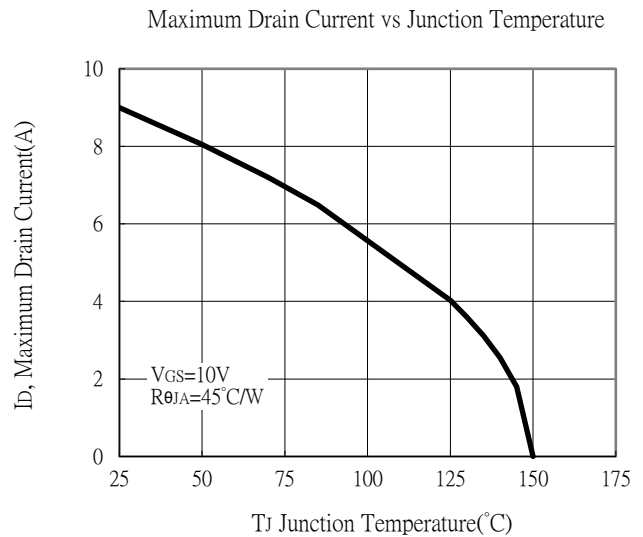
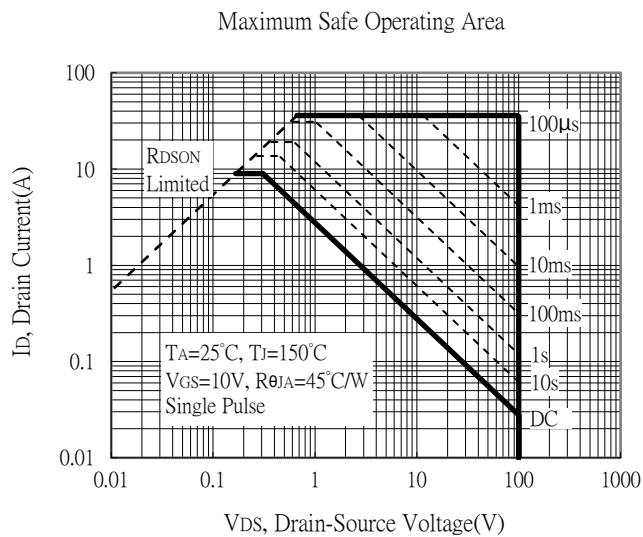
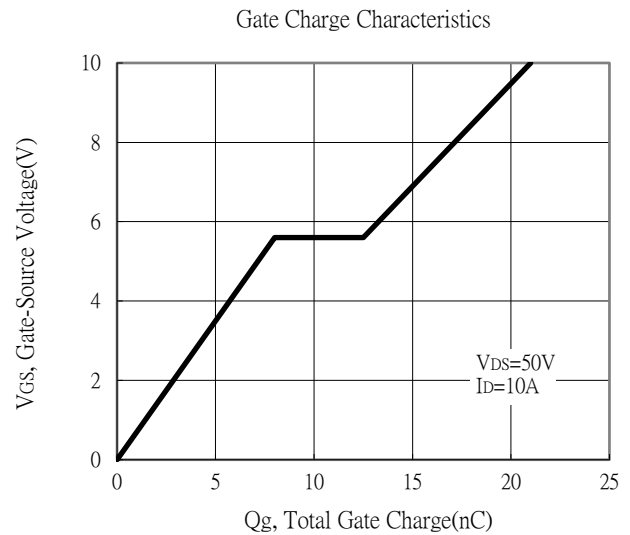
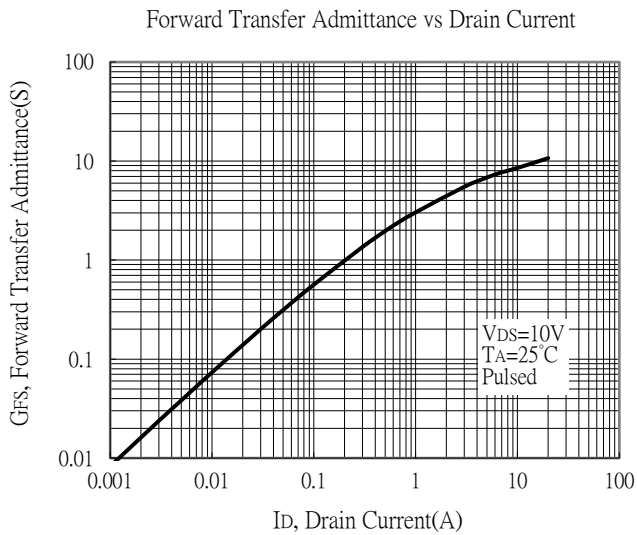
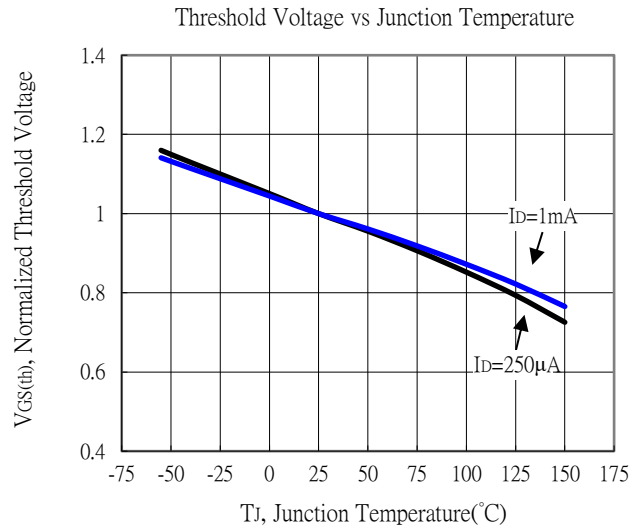
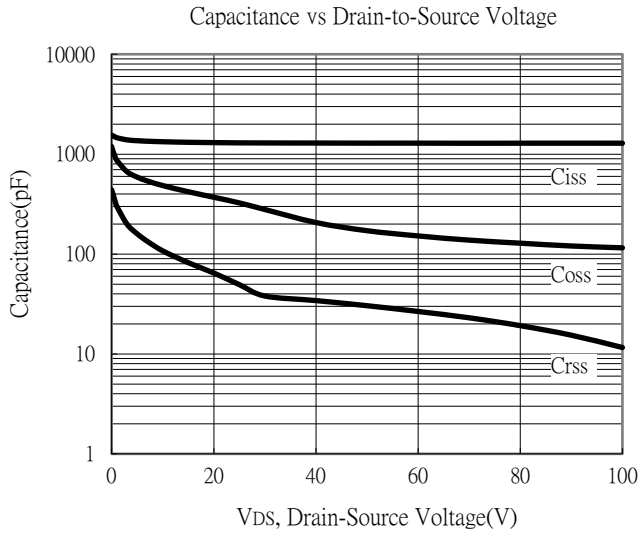

## Typical Characteristics

Single Pulse Power Rating, Junction to Ambient

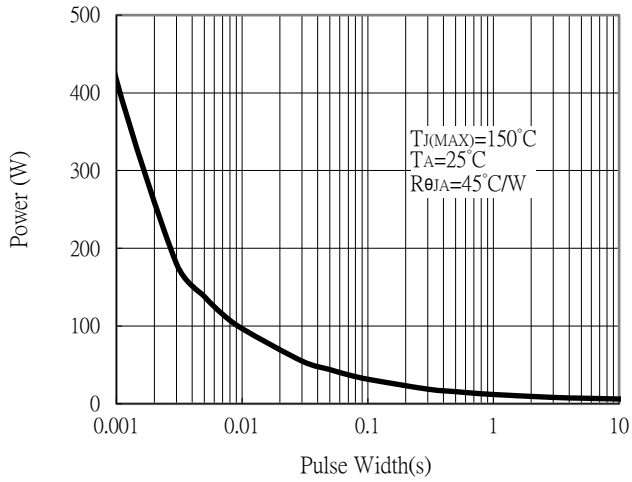

Transient Thermal Response Curves

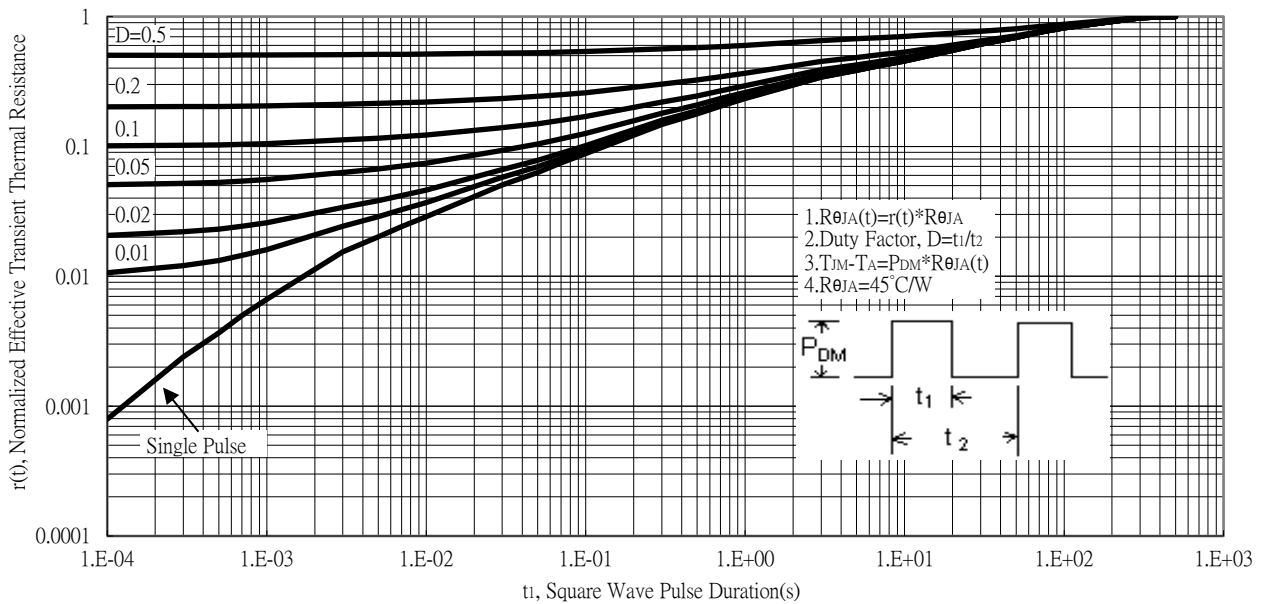

## DFN5×6 Dimension

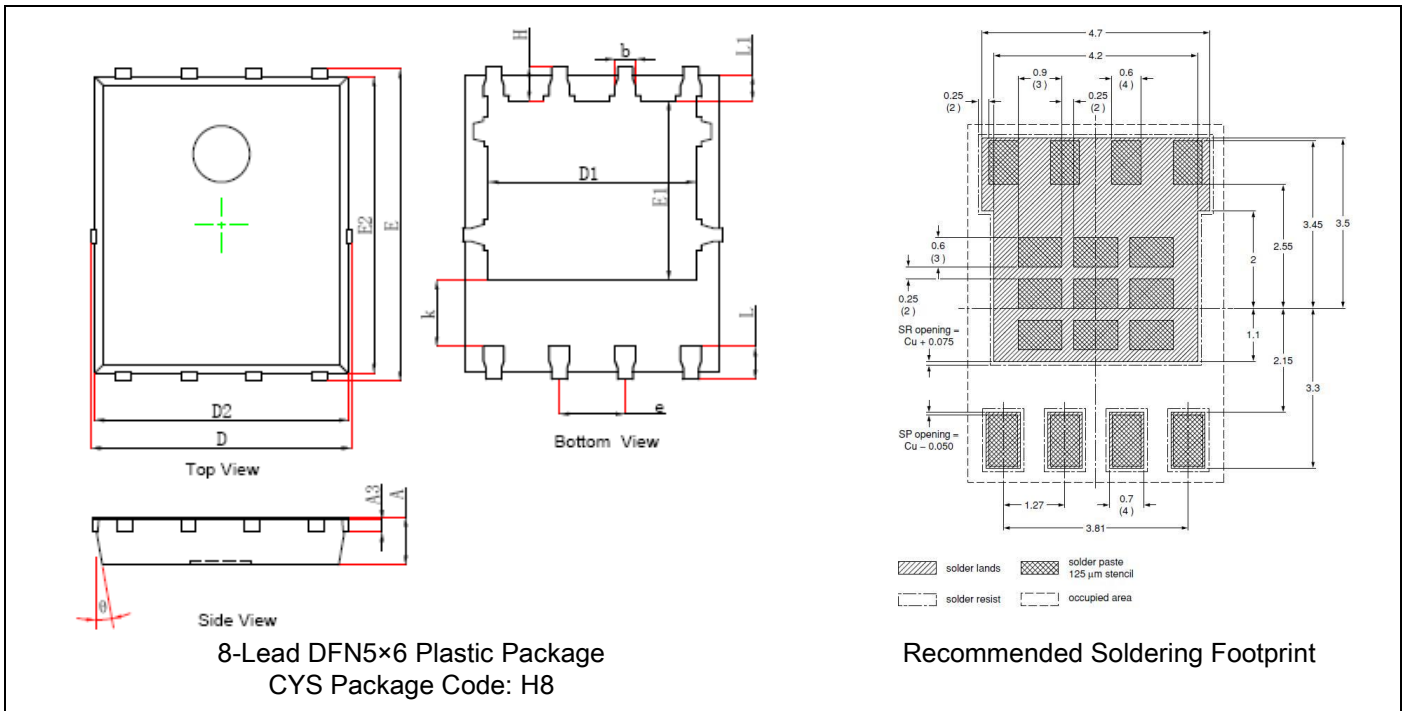

DIM	Inches		Millimeters		DIM	Inches		Millimeters	
	Min.	Max.	Min.	Max.		Min.	Max.	Min.	Max.
A	0.035	0.039	0.900	1.000	k	0.047	0.055	1.190	1.390
A3	0.010	REF.	0.254	REF.	b	0.014	0.018	0.350	0.450
D	0.195	0.201	4.944	5.096	e	0.050	TYP.	1.270	TYP.
E	0.235	0.241	5.974	6.126	L	0.020	0.028	0.559	0.711
D1	0.154	0.162	3.910	4.110	L1	0.017	0.023	0.424	0.576
E1	0.133	0.141	3.375	3.575	H	0.023	0.029	0.574	0.726
D2	0.190	0.196	4.824	4.976	θ	8°	12°	8°	12°
E2	0.223	0.229	5.674	5.826					

**Note:**

- Controlling dimension: millimeters.
- Maximum lead thickness includes lead finish thickness, and minimum lead thickness is the minimum thickness of base material.
- If there is any question with packing specification or packing method, please contact your local CYStek sales office.

**Material:**

- Lead: pure tin plated.
- Mold Compound: Epoxy resin family, flammability solid burning class: UL94V-0.

**Important Notice:**

- All rights are reserved. Reproduction in whole or in part is prohibited without the prior written approval of CYStek.
- CYStek reserves the right to make changes to its products without notice.
- CYStek semiconductor products are not warranted to be suitable for use in Life-Support Applications, or systems.
- CYStek assumes no liability for any consequence of customer product design, infringement of patents, or application assistance.

## Reel Dimension

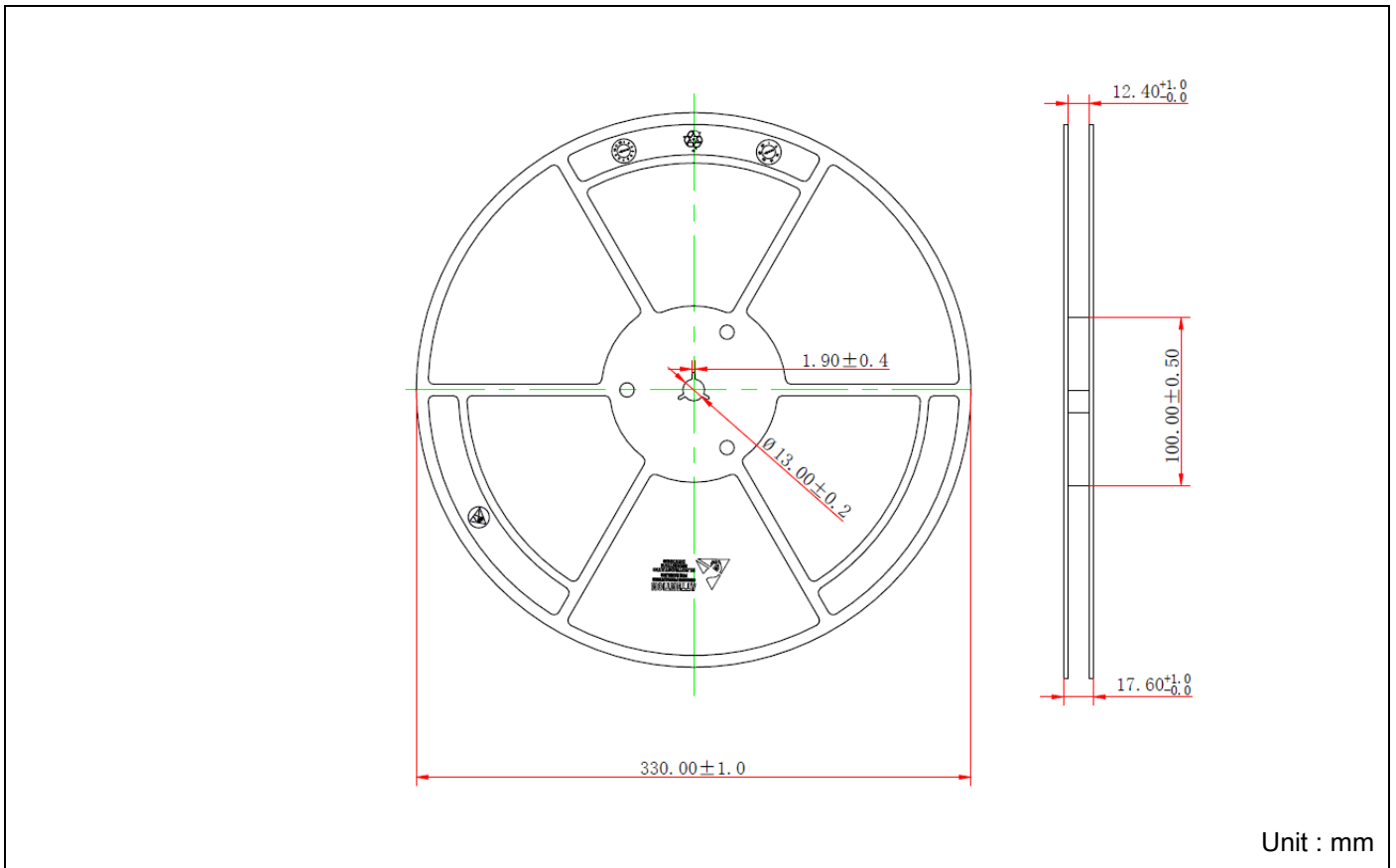

## Carrier Tape Dimension

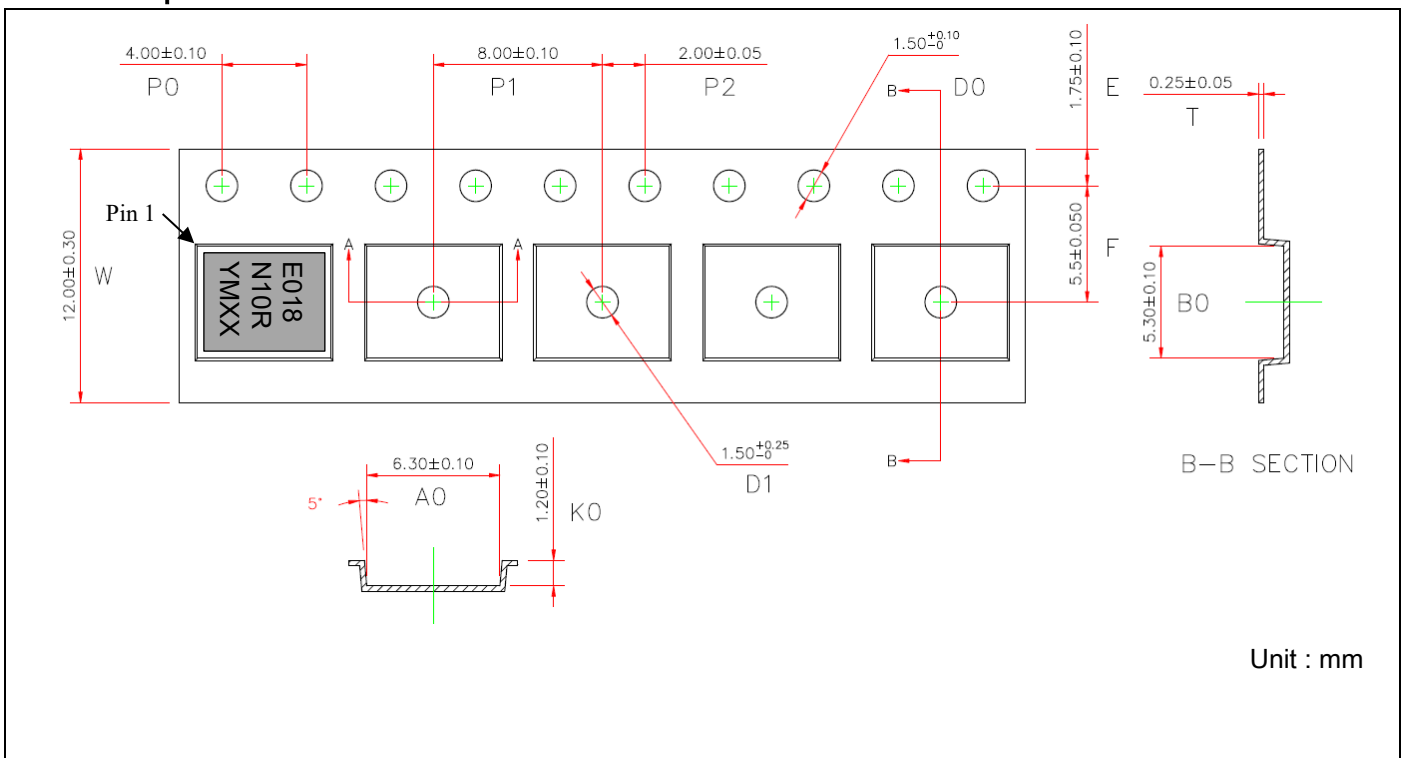

**Recommended wave soldering condition**

Product	Peak Temperature	Soldering Time
Pb-free devices	260 +0/-5 °C	5 +1/-1 seconds

**Recommended temperature profile for IR reflow**

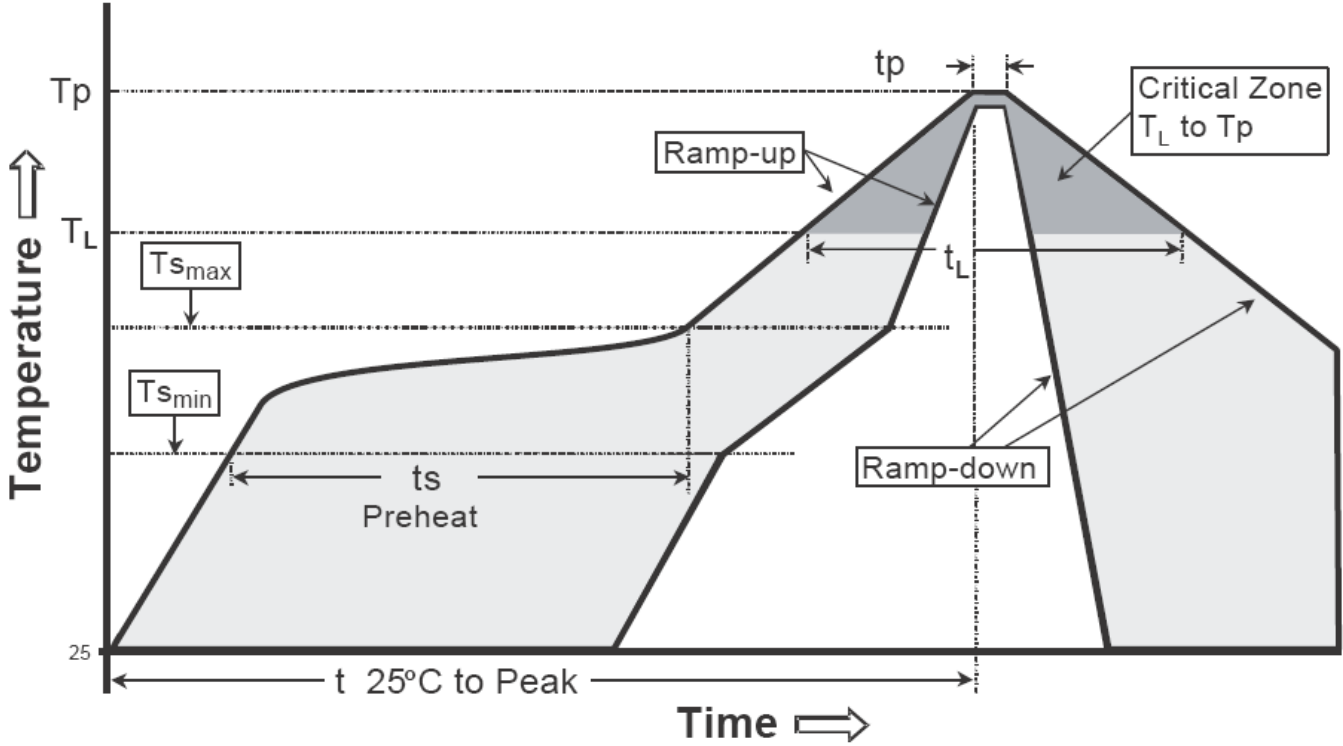

Profile feature	Sn-Pb eutectic Assembly	Pb-free Assembly
Average ramp-up rate (T <sub>S</sub> max to T <sub>P</sub> )	3°C/second max.	3°C/second max.
Preheat -Temperature Min (T <sub>S</sub> min) -Temperature Max (T <sub>S</sub> max) -Time (t <sub>s</sub> min to t <sub>s</sub> max)	100°C 150°C 60-120 seconds	150°C 200°C 60-180 seconds
Time maintained above: -Temperature (T <sub>L</sub> ) -Time (t <sub>L</sub> )	183°C 60-150 seconds	217°C 60-150 seconds
Peak Temperature (T <sub>P</sub> )	240 +0/-5 °C	260 +0/-5 °C
Time within 5°C of actual peak temperature (t <sub>P</sub> )	10-30 seconds	20-40 seconds
Ramp down rate	6°C/second max.	6°C/second max.
Time 25 °C to peak temperature	6 minutes max.	8 minutes max.

**Note:**

- All temperatures refer to topside of the package, measured on the package body surface.