

**N-Channel Enhancement Mode Power MOSFET**

# MTE013N08H8

<b>BV<sub>DSS</sub></b>	<b>80V</b>
<b>I<sub>D</sub>@V<sub>GS</sub>=10V, T<sub>C</sub>=25°C</b>	<b>40A</b>
<b>I<sub>D</sub>@V<sub>GS</sub>=10V, T<sub>A</sub>=25°C</b>	<b>10.5A</b>
<b>R<sub>DS(ON)</sub>@V<sub>GS</sub>=10V, I<sub>D</sub>=10A</b>	<b>9.1 mΩ (typ)</b>

**Features**

- Low On Resistance
- Simple Drive Requirement
- Low Gate Charge
- Fast Switching Characteristic
- Pb-free lead plating and halogen-free package

**Symbol**

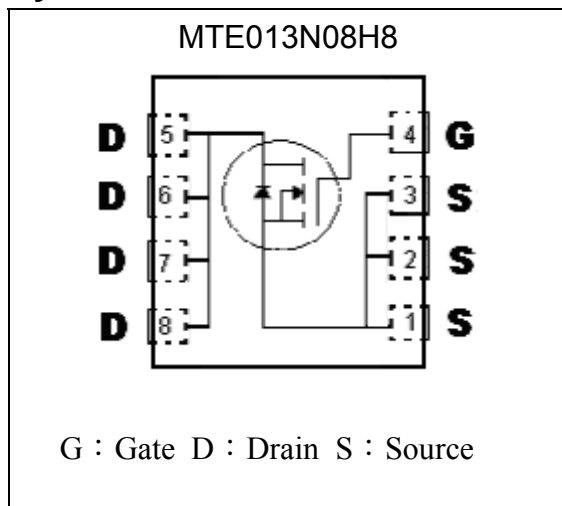

**Outline**

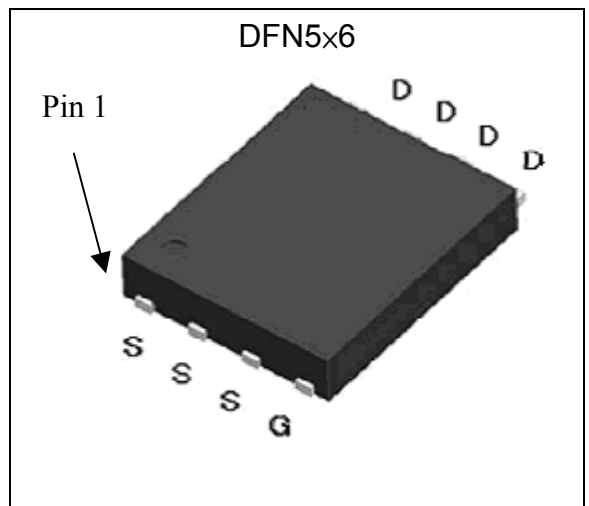

**Ordering Information**

Device	Package	Shipping
MTE013N08H8-0-T6-G	DFN5x6 (Pb-free lead plating and halogen-free package)	3000 pcs / Tape & Reel

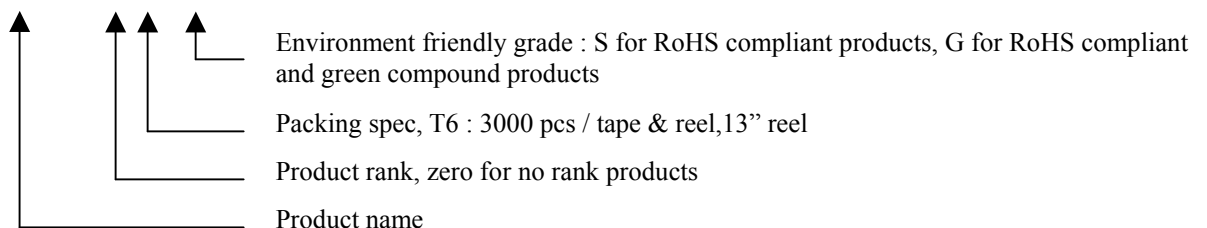

**Absolute Maximum Ratings** ( $T_C=25^\circ\text{C}$ )

Parameter	Symbol	Limits	Unit
Drain-Source Voltage (Note 1)	$V_{DS}$	80	V
Gate-Source Voltage	$V_{GS}$	$\pm 20$	
Continuous Drain Current @ $T_C=25^\circ\text{C}$ , $V_{GS}=10\text{V}$ (silicon limit) (Note 4)	$I_D$	57	A
Continuous Drain Current @ $T_C=25^\circ\text{C}$ , $V_{GS}=10\text{V}$ (package limit) (Note 4)		40	
Continuous Drain Current @ $T_C=100^\circ\text{C}$ , $V_{GS}=10\text{V}$		36	
Continuous Drain Current @ $T_A=25^\circ\text{C}$ , $V_{GS}=10\text{V}$ (Note 2)	$I_{DSM}$	10.5	
Continuous Drain Current @ $T_A=70^\circ\text{C}$ , $V_{GS}=10\text{V}$ (Note 2)		8.4	
Pulsed Drain Current (Note 1)	$I_{DM}$	160	
Single Pulse Avalanche Current @ $L=0.1\text{mH}$	$I_{AS}$	40	
Single Pulse Avalanche Energy @ $L=5\text{mH}$ , $I_D=20\text{Amps}$ , $V_{DD}=30\text{V}$ (Note 3)	$E_{AS}$	1000	mJ
Repetitive Avalanche Energy	$E_{AR}$	6.9	
Power Dissipation	$P_D$	$T_C=25^\circ\text{C}$	69
		$T_C=100^\circ\text{C}$	27
	$P_{DSM}$	$T_A=25^\circ\text{C}$ (Note 2)	2.5
		$T_A=70^\circ\text{C}$ (Note 2)	1.6
Operating Junction and Storage Temperature	$T_j, T_{stg}$	-55~+150	

\*Drain current limited by maximum junction temperature

**Thermal Data**

Parameter	Symbol	Value	Unit
Thermal Resistance, Junction-to-case, max	$R_{\theta JC}$	1.8	$^\circ\text{C/W}$
Thermal Resistance, Junction-to-ambient, max (Note 2)	$R_{\theta JA}$	50	

- Note :
1. Pulse width limited by junction temperature.
  2. Surface mounted on 1 in<sup>2</sup> copper pad of FR-4 board, 125 $^\circ\text{C/W}$  when mounted on minimum copper pad
  3. Ratings are based on low frequency and low duty cycles to keep initial  $T_j=25^\circ\text{C}$ . 100% tested by conditions of  $V_{DD}=30\text{V}$ ,  $I_D=20\text{A}$ ,  $L=0.1\text{mH}$ ,  $V_{GS}=10\text{V}$ .
  4. Calculated continuous drain current based on maximum allowable junction temperature.
  5. The static characteristics are obtained using <300 $\mu\text{s}$  pulses, duty cycle 0.5% maximum.
  6. The  $R_{\theta JA}$  is the sum of thermal resistance from junction to case  $R_{\theta JC}$  and case to ambient.



**Characteristics (Tj=25°C, unless otherwise specified)**

Symbol	Min.	Typ.	Max.	Unit	Test Conditions
<b>Static</b>					
BV <sub>DSS</sub>	80	-	-	V	V <sub>GS</sub> =0V, I <sub>D</sub> =250μA
ΔBV <sub>DSS</sub> /ΔT <sub>j</sub>	-	68	-	mV/°C	Reference to 25°C, I <sub>D</sub> =250μA
V <sub>GS(th)</sub>	2	-	4	V	V <sub>DS</sub> = V <sub>GS</sub> , I <sub>D</sub> =250μA
*G <sub>FS</sub>	-	19	-	S	V <sub>DS</sub> =10V, I <sub>D</sub> =20A
I <sub>GSS</sub>	-	-	±100	nA	V <sub>GS</sub> =±20V
I <sub>DSS</sub>	-	-	1	μA	V <sub>DS</sub> =64V, V <sub>GS</sub> =0V
	-	-	5		V <sub>DS</sub> =64V, V <sub>GS</sub> =0V, T <sub>j</sub> =55°C
*R <sub>DS(ON)</sub>	-	9.1	11.5	mΩ	V <sub>GS</sub> =10V, I <sub>D</sub> =10A
<b>Dynamic</b>					
*Q <sub>g</sub> (V <sub>GS</sub> =10V)	-	31.4	-	nC	V <sub>DS</sub> =40V, V <sub>GS</sub> =10V, I <sub>D</sub> =10.5A
*Q <sub>g</sub> (V <sub>GS</sub> =8V)	-	26	-		
*Q <sub>gs</sub>	-	7.3	-		
*Q <sub>gd</sub>	-	10.1	-		
*t <sub>d(ON)</sub>	-	18.6	-	ns	V <sub>DS</sub> =40V, I <sub>D</sub> =10.5A, V <sub>GS</sub> =10V, R <sub>GS</sub> =6Ω
*tr	-	26.2	-		
*t <sub>d(OFF)</sub>	-	46	-		
*tr	-	15.8	-		
C <sub>iss</sub>	-	1472	-	pF	V <sub>GS</sub> =0V, V <sub>DS</sub> =30V, f=1MHz
C <sub>oss</sub>	-	200	-		
C <sub>rss</sub>	-	105	-		
R <sub>g</sub>	-	3.8	-		
<b>Source-Drain Diode</b>					
*I <sub>S</sub>	-	-	40	A	
*I <sub>SM</sub>	-	-	160		
*V <sub>SD</sub>	-	0.74	1.1	V	I <sub>S</sub> =2.8A, V <sub>GS</sub> =0V
*trr	-	24.4	-	ns	V <sub>GS</sub> =0V, I <sub>F</sub> =10.5A, dI <sub>F</sub> /dt=100A/μs
*Q <sub>rr</sub>	-	26.9	-	nC	

\*Pulse Test : Pulse Width ≤300μs, Duty Cycle≤2%

### Recommended Soldering Footprint

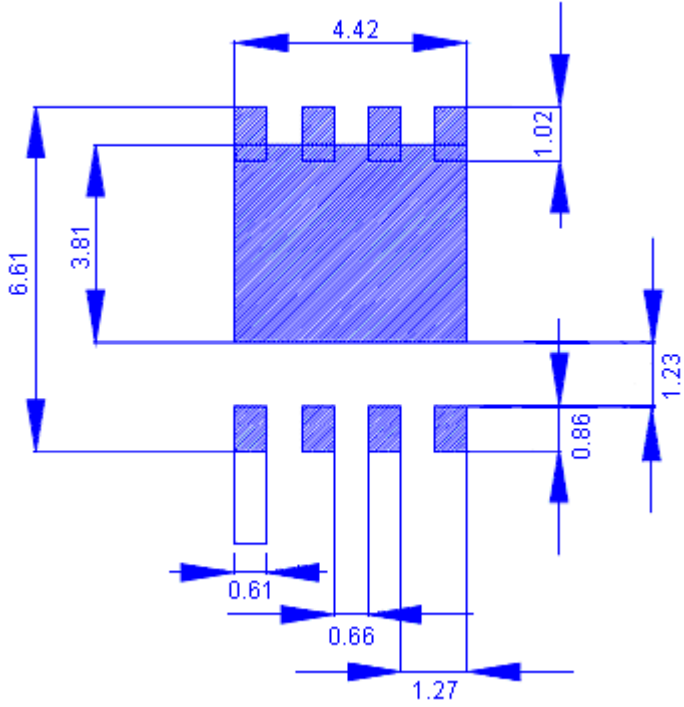

unit : mm



**Typical Characteristics**

Typical Output Characteristics

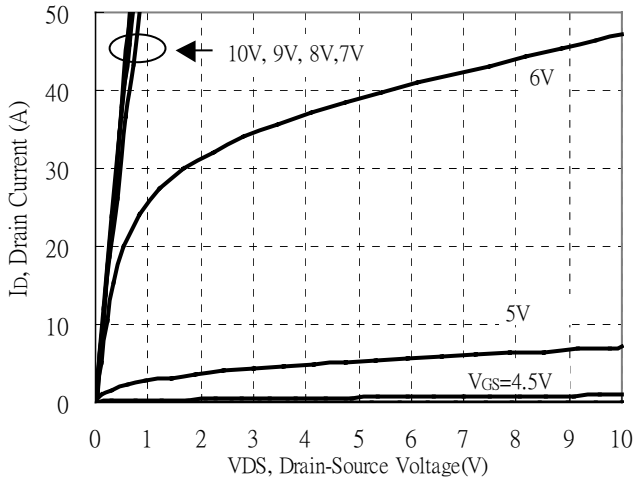

Brekdown Voltage vs Junction Temperature

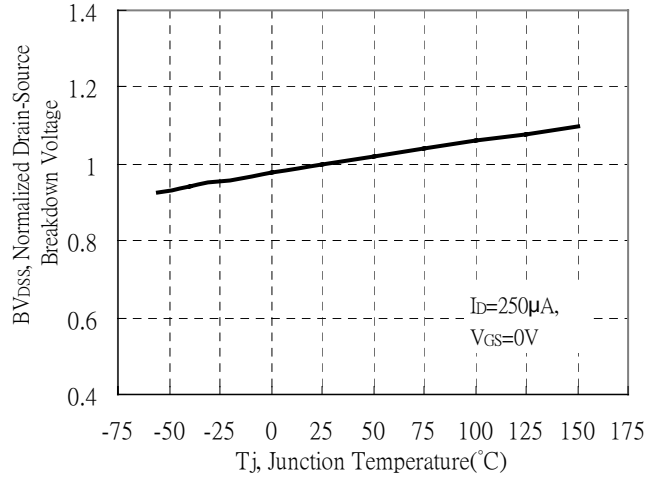

Static Drain-Source On-State resistance vs Drain Current

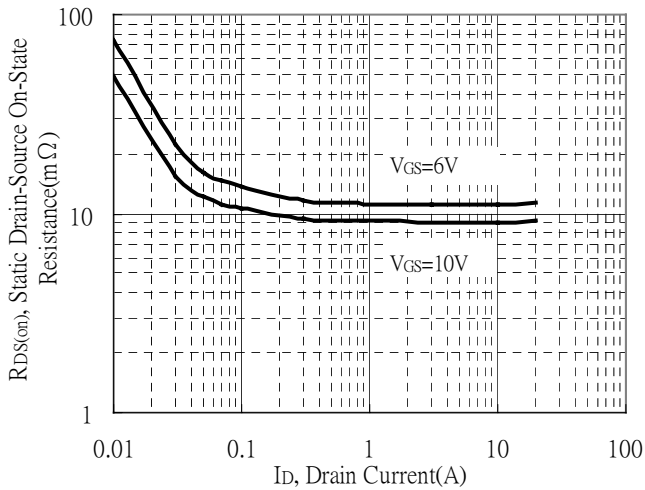

Reverse Drain Current vs Source-Drain Voltage

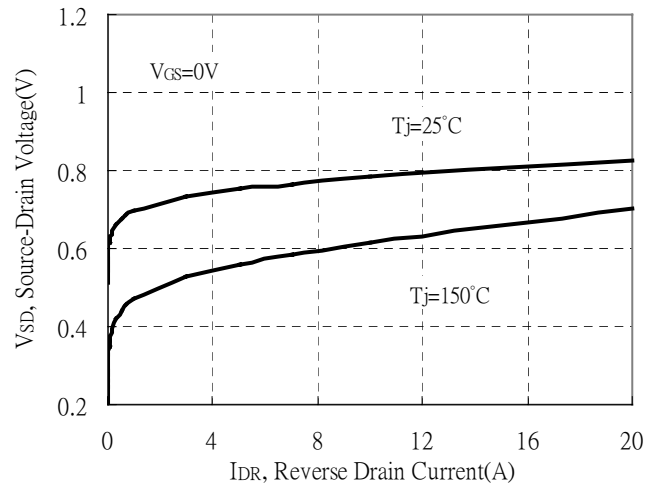

Static Drain-Source On-State Resistance vs Gate-Source Voltage

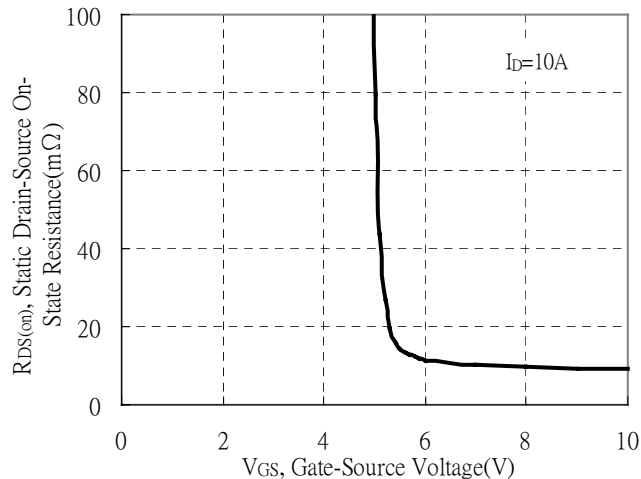

Drain-Source On-State Resistance vs Junction Temperature

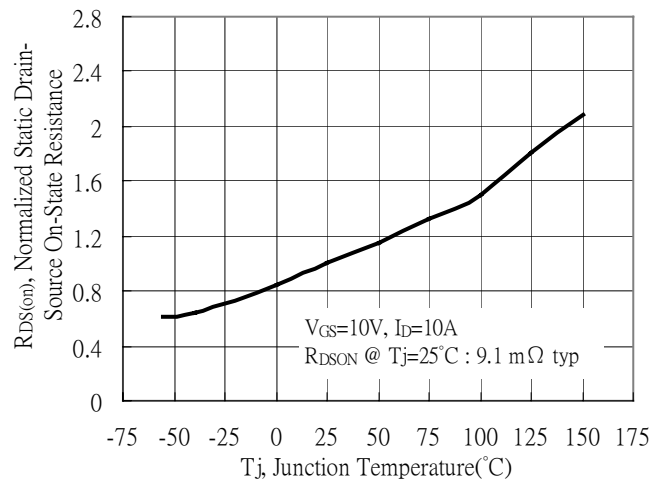



**Typical Characteristics(Cont.)**

Capacitance vs Drain-to-Source Voltage

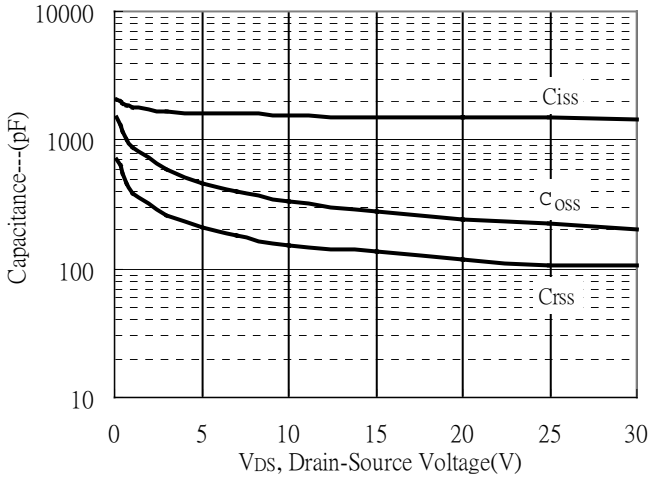

Threshold Voltage vs Junction Temperature

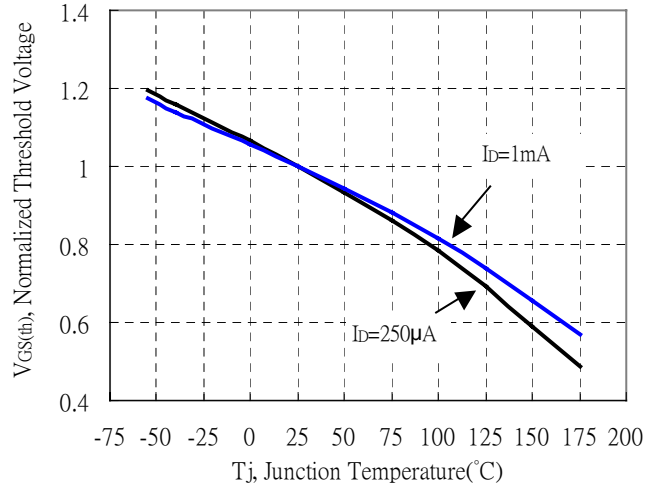

Forward Transfer Admittance vs Drain Current

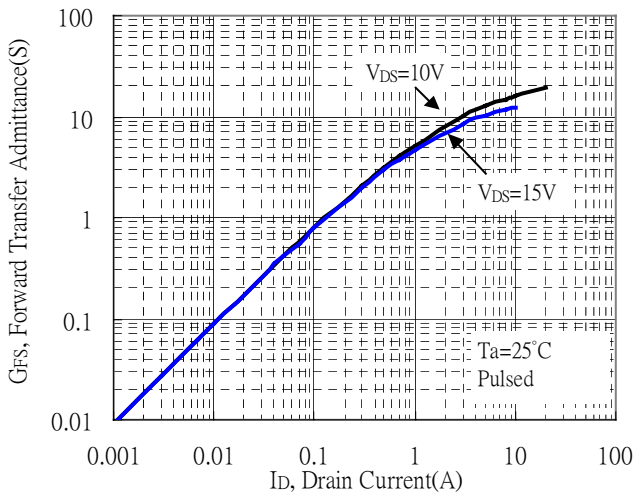

Gate Charge Characteristics

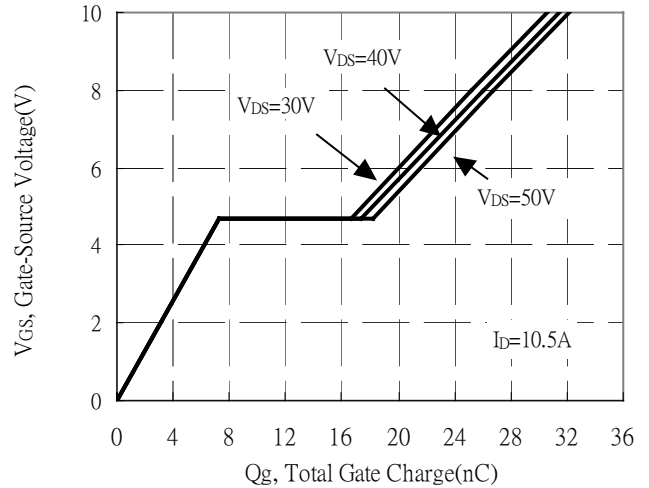

Maximum Safe Operating Area

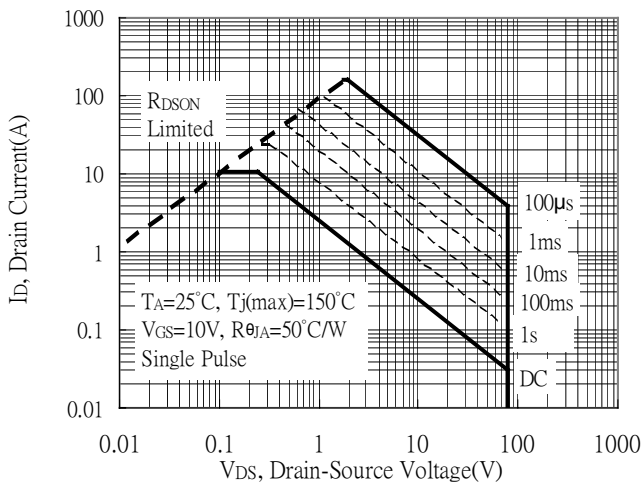

Maximum Drain Current vs Case Temperature

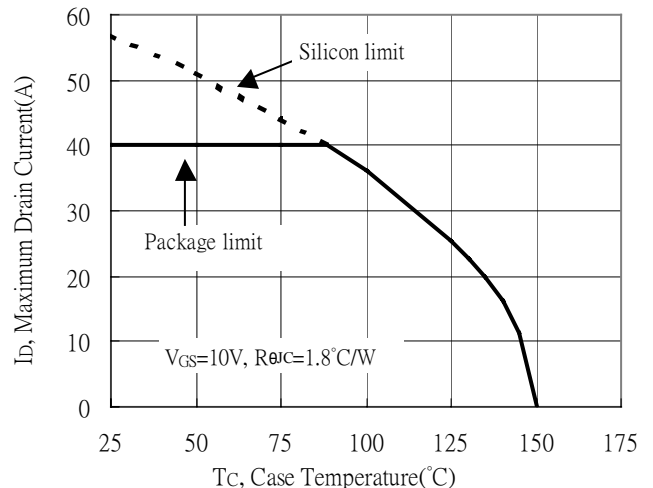



**Typical Characteristics(Cont.)**

Typical Transfer Characteristics

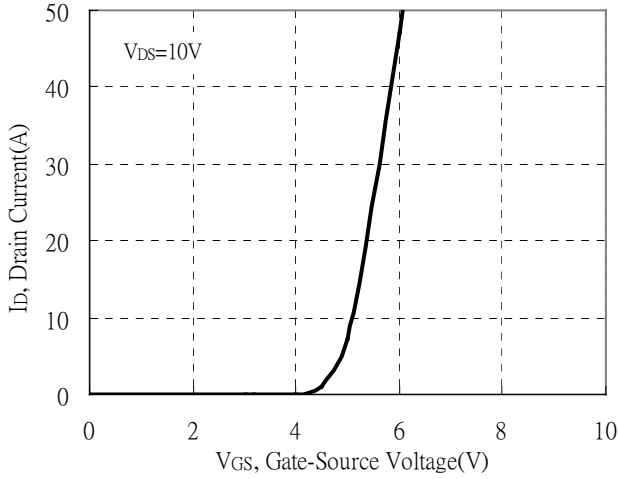

Single Pulse Power Rating, Junction to Case

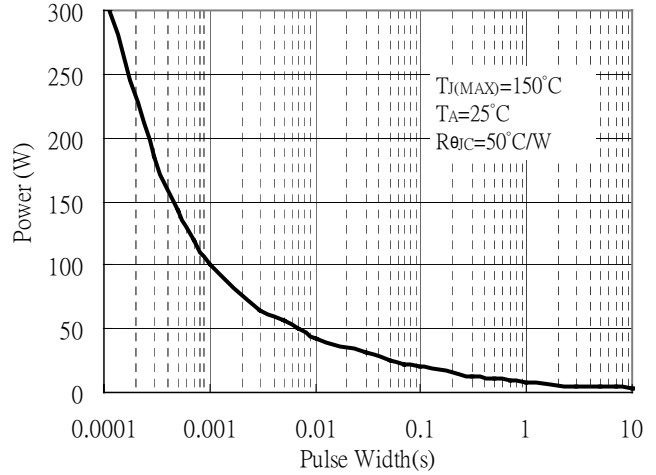

Transient Thermal Response Curves

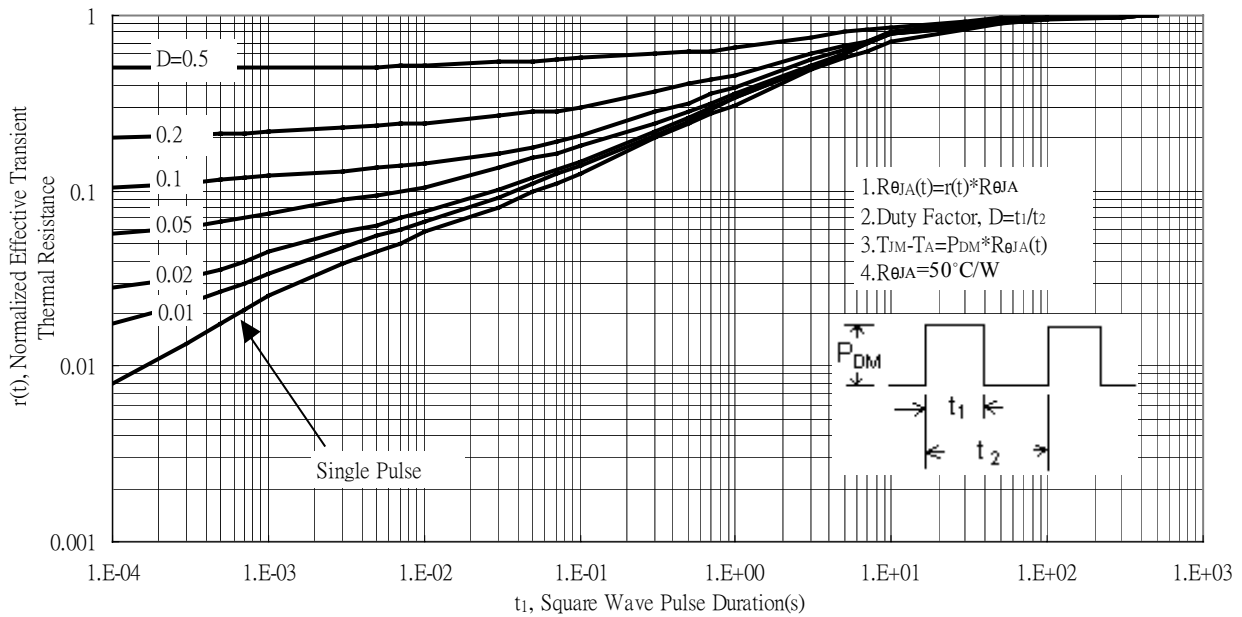

**Reel Dimension**

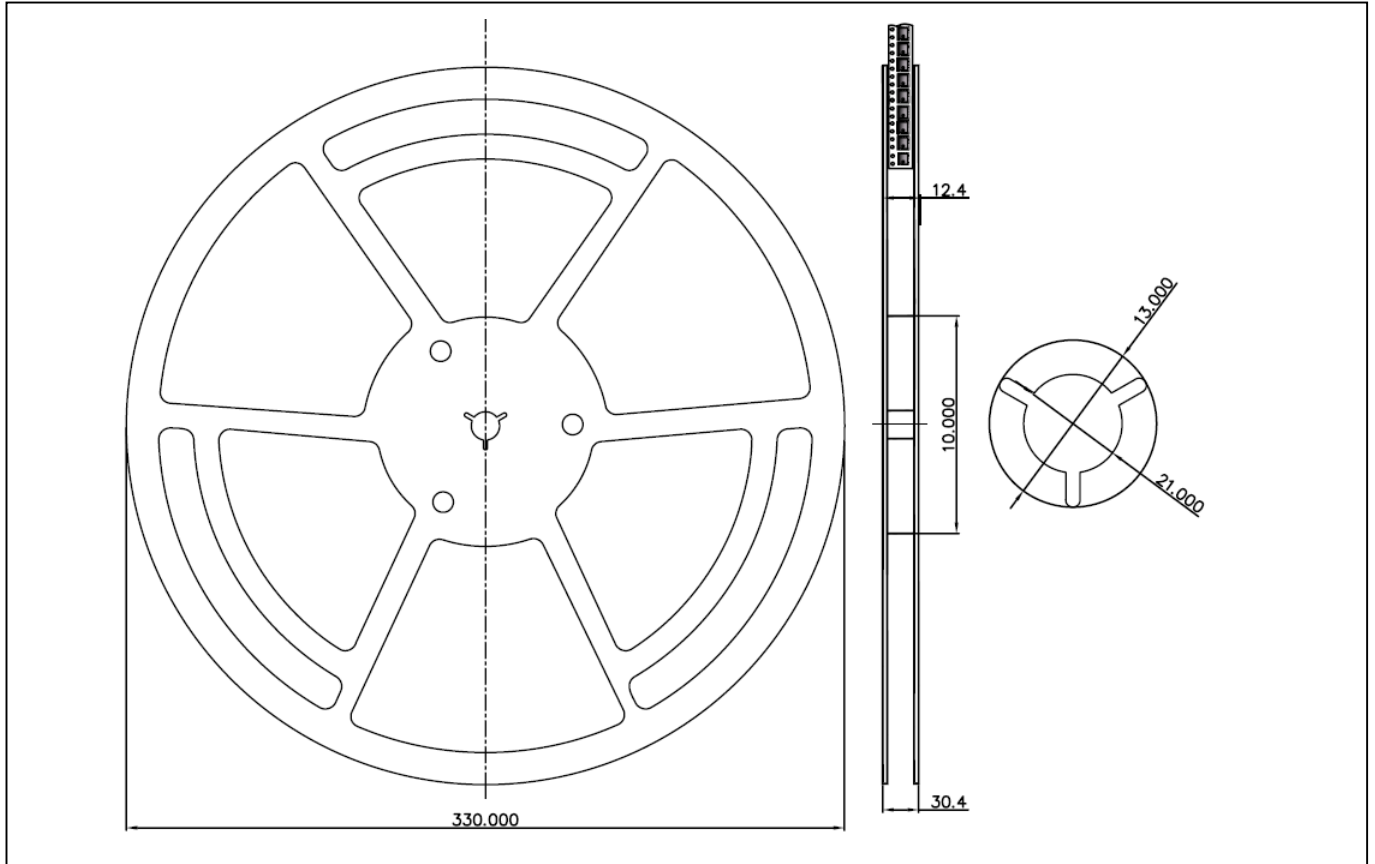

**Carrier Tape Dimension**

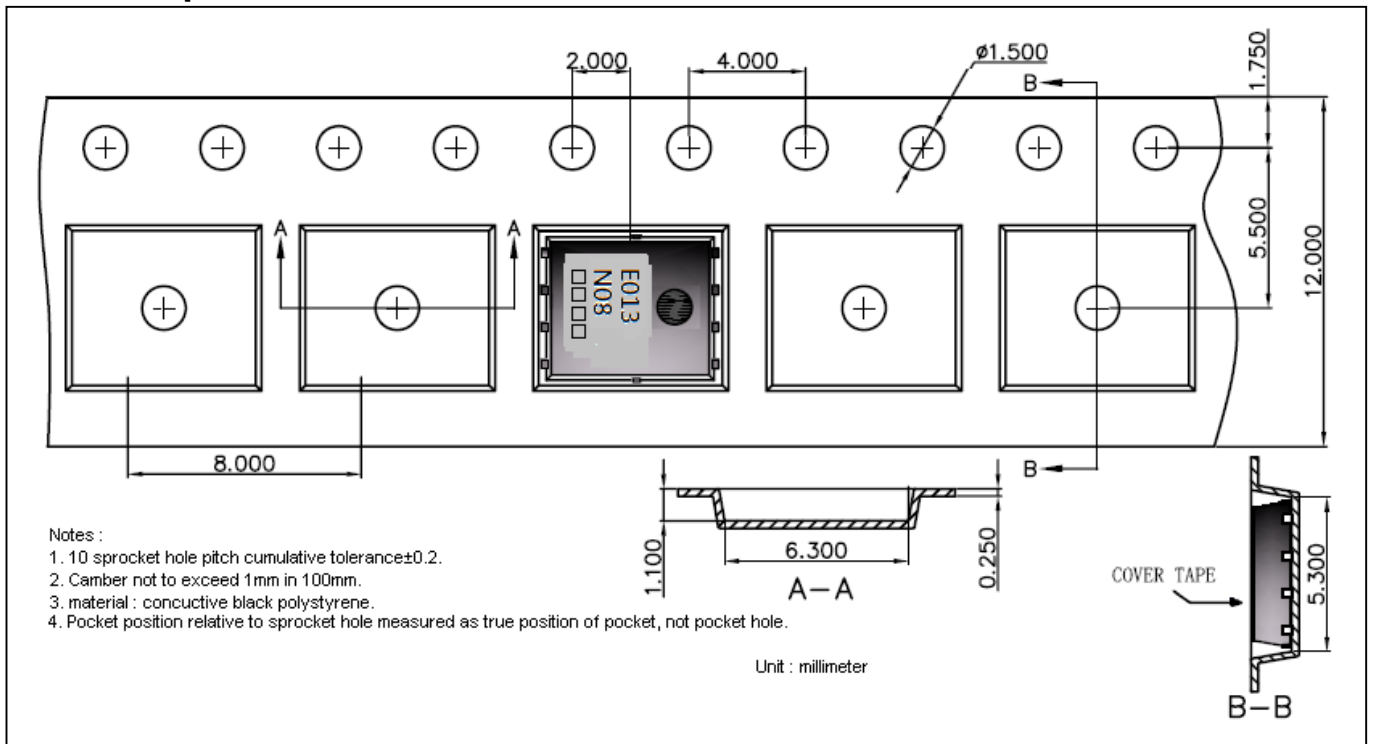



**Recommended wave soldering condition**

Product	Peak Temperature	Soldering Time
Pb-free devices	260 +0/-5 °C	5 +1/-1 seconds

**Recommended temperature profile for IR reflow**

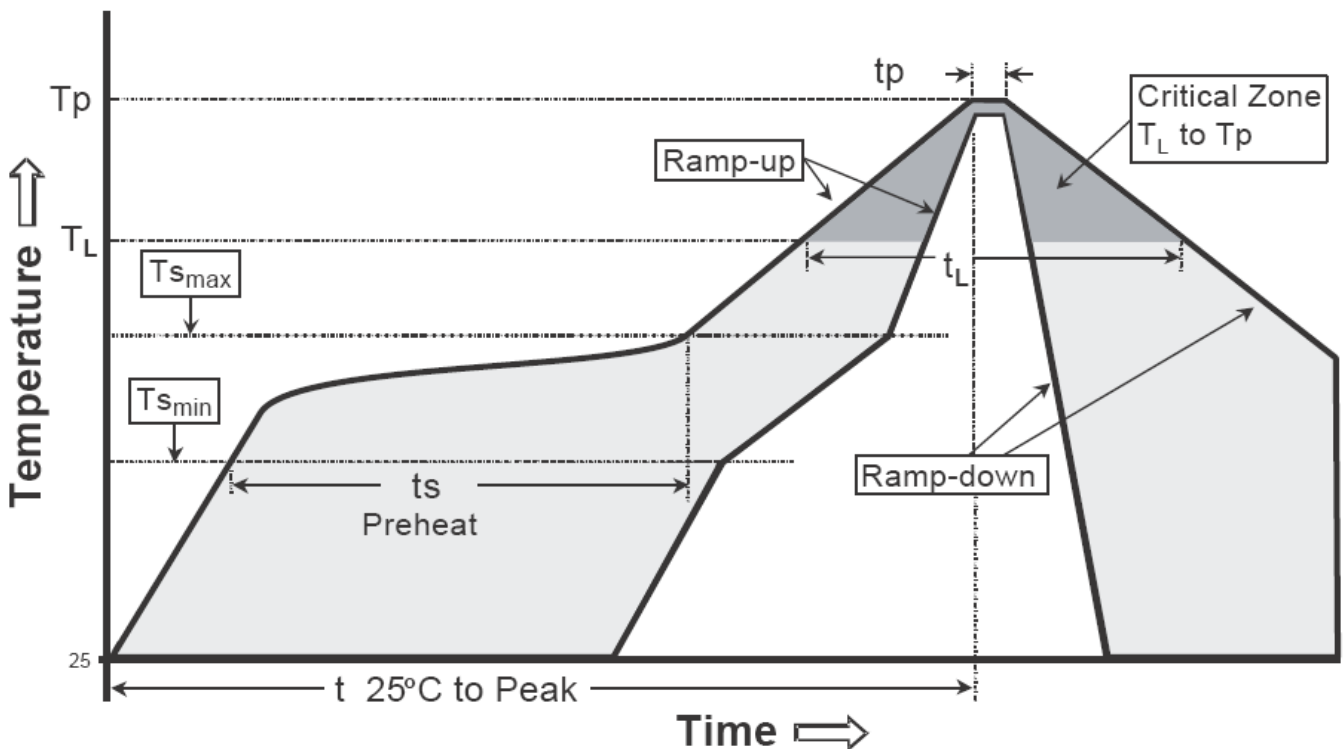

Profile feature	Sn-Pb eutectic Assembly	Pb-free Assembly
Average ramp-up rate (T <sub>smax</sub> to T <sub>p</sub> )	3°C/second max.	3°C/second max.
Preheat		
-Temperature Min(T <sub>s min</sub> )	100°C	150°C
-Temperature Max(T <sub>s max</sub> )	150°C	200°C
-Time(t <sub>s min</sub> to t <sub>s max</sub> )	60-120 seconds	60-180 seconds
Time maintained above:		
-Temperature (T <sub>L</sub> )	183°C	217°C
- Time (t <sub>L</sub> )	60-150 seconds	60-150 seconds
Peak Temperature(T <sub>p</sub> )	240 +0/-5 °C	260 +0/-5 °C
Time within 5°C of actual peak temperature(t <sub>p</sub> )	10-30 seconds	20-40 seconds
Ramp down rate	6°C/second max.	6°C/second max.
Time 25 °C to peak temperature	6 minutes max.	8 minutes max.

Note : All temperatures refer to topside of the package, measured on the package body surface.

**DFN5x6 Dimension**

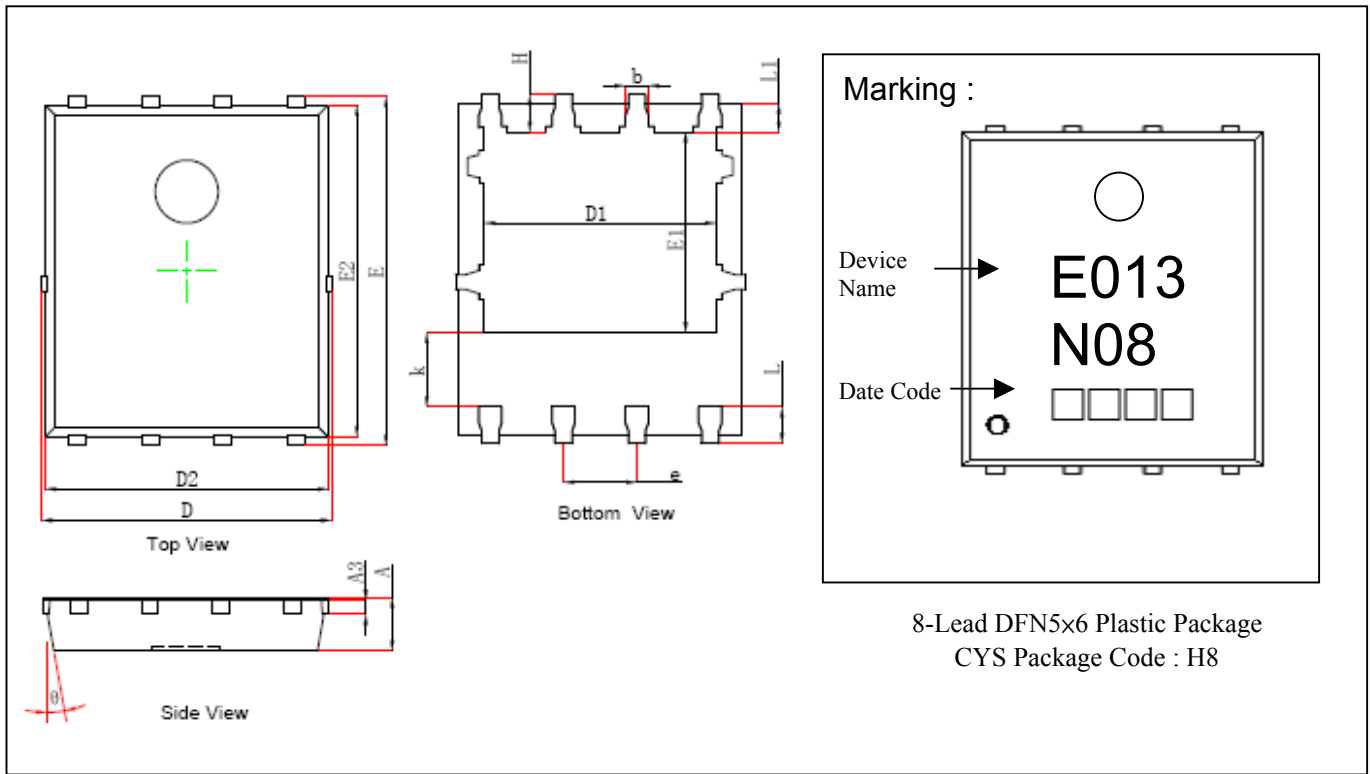

DIM	Millimeters		Inches		DIM	Millimeters		Inches	
	Min.	Max.	Min.	Max.		Min.	Max.	Min.	Max.
A	0.900	1.000	0.035	0.039	k	1.190	1.390	0.047	0.055
A3	0.254	REF	0.010	REF	b	0.350	0.450	0.014	0.018
D	4.944	5.096	0.195	0.201	e	1.270	TYP.	0.050	TYP.
E	5.974	6.126	0.235	0.241	L	0.559	0.711	0.022	0.028
D1	3.910	4.110	0.154	0.162	L1	0.424	0.576	0.017	0.023
E1	3.375	3.575	0.133	0.141	H	0.574	0.726	0.023	0.029
D2	4.824	4.976	0.190	0.196	θ	10°	12°	10°	12°
E2	5.674	5.826	0.223	0.229					

**Notes:** 1.Controlling dimension: millimeters.  
 2.Maximum lead thickness includes lead finish thickness, and minimum lead thickness is the minimum thickness of base material.  
 3.If there is any question with packing specification or packing method, please contact your local CYStek sales office.

**Material:**

- Lead: Pure tin plated.
- Mold Compound: Epoxy resin family, flammability solid burning class: UL94V-0.

**Important Notice:**

- All rights are reserved. Reproduction in whole or in part is prohibited without the prior written approval of CYStek.
- CYStek reserves the right to make changes to its products without notice.
- CYStek **semiconductor products are not warranted for use in Life-Support Applications, or systems.**
- CYStek assumes no liability for any consequence of customer product design, infringement of patents, or application assistance.