

Dual N-Channel Enhancement Mode MOSFET

MTDK9S6R

Features

- ESD protected gate, typical 3kV (HBM)
- High speed switching
- Easily designed drive circuits
- Low-voltage drive
- Easy to use in parallel
- RoHS compliant package

BV_{DSS}	20V
$I_D @ V_{GS}=4.5V, T_A=25^\circ C$	0.63A
$R_{DS(ON) \text{ typ.}} @ V_{GS}=4.5V, I_D=0.2A$	0.32Ω
$R_{DS(ON) \text{ typ.}} @ V_{GS}=2.5V, I_D=0.2A$	0.4Ω
$R_{DS(ON) \text{ typ.}} @ V_{GS}=1.8V, I_D=0.2A$	0.8Ω

Equivalent Circuit

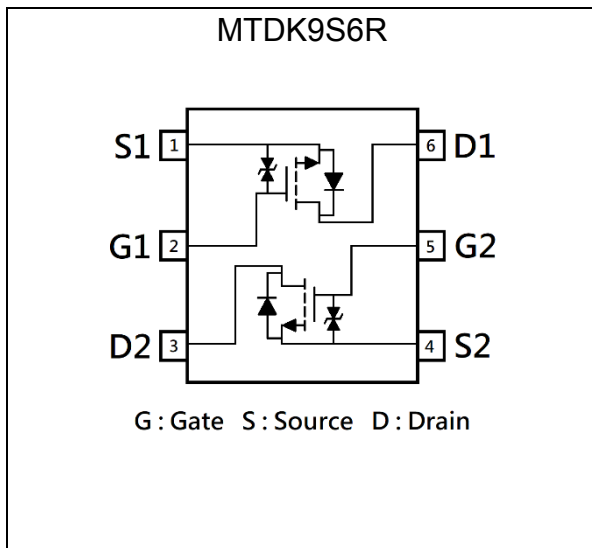

Outline

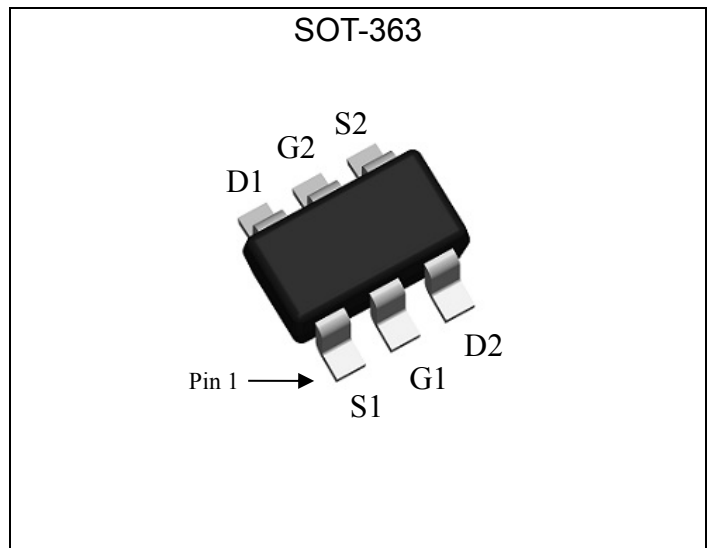

Ordering Information

Device	Package	Shipping
MTDK9S6R-0-T1-G	SOT-363 (Pb-free lead plating and halogen-free package)	3000 pcs / Tape & Reel

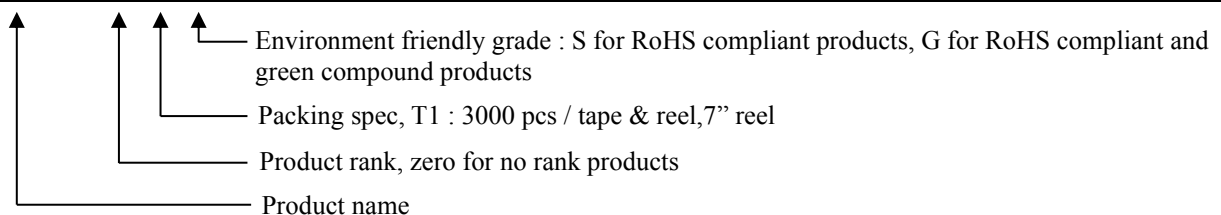

**Absolute Maximum Ratings (T_A=25°C)**

Parameter	Symbol	Limits	Unit
Drain-Source Voltage	V _{DS}	20	V
Gate-Source Voltage	V _{GS}	±8	
Continuous Drain Current @ V _{GS} =4.5V, T _A =25°C	I _D	0.63	A
Continuous Drain Current @ V _{GS} =4.5V, T _A =70°C		0.50	
Pulsed Drain Current *a	I _{DM}	2.5	
Continuous Body Diode Forward Current @ T _A =25°C	I _S	0.2	
ESD susceptibility *b	V _{ESD}	3000	V
Total Power Dissipation @ T _A =25°C	P _D	0.3	W
Operating Junction and Storage Temperature Range	T _J , T _{stg}	-55~+150	°C

Thermal Data

Parameter	Symbol	Steady State	Unit
Thermal Resistance, Junction-to-ambient	R _{θJA}	417	°C/W

Note:

*a. Repetitive rating, pulse width limited by junction temperature T_{J(MAX)}=150°C. Ratings are based on low frequency and low duty cycles to keep initial T_J=25°C.

*b. Human body model, 1.5kΩ in series with 100pF.



Electrical Characteristics (T_A=25°C, unless otherwise specified)

Symbol	Min.	Typ.	Max.	Unit	Test Conditions
Static					
BV _{DSS}	20	-	-	V	V _{GS} =0V, I _D =250μA
V _{GS(th)}	0.3	-	1.2		V _{DS} =V _{GS} , I _D =250μA
G _{FS}	-	1	-	S	V _{DS} =5V, I _D =0.2A
I _{GSS}	-	-	±10	μA	V _{GS} =±8V, V _{DS} =0V
I _{DSS}	-	-	1		V _{DS} =16V, V _{GS} =0V
R _{DS(ON)}	-	0.32	0.45	Ω	V _{GS} =4.5V, I _D =0.2A
	-	0.4	0.6		V _{GS} =2.5V, I _D =0.2A
	-	0.8	1.2		V _{GS} =1.8V, I _D =0.2A
Dynamic					
C _{iss}	-	32	-	pF	V _{DS} =10V, V _{GS} =0V, f=1MHz
C _{oss}	-	19	-		
C _{rss}	-	17	-		
Q _g *1, 2	-	0.8	-	nC	V _{DS} =10V, I _D =0.2A, V _{GS} =4.5V
Q _{gs} *1, 2	-	0.2	-		
Q _{gd} *1, 2	-	0.15	-		
t _{d(ON)} *1, 2	-	4.8	-	ns	V _{DS} =10V, I _D =0.2A, V _{GS} =4.5V, R _{GS} =10Ω
t _r *1, 2	-	16	-		
t _{d(OFF)} *1, 2	-	20	-		
t _f *1, 2	-	15.6	-		
Source-Drain Diode					
V _{SD} *1	-	0.8	1.2	V	I _S =0.2A, V _{GS} =0V
t _{rr}	-	7	-	ns	I _F =0.2A, dI _F /dt=100A/μs
Q _{rr}	-	1	-	nC	

Note:

*1. Pulse Test : Pulse Width ≤300μs, Duty Cycle≤2%

*2. Independent of operating temperature

Typical Characteristics

Typical Output Characteristics

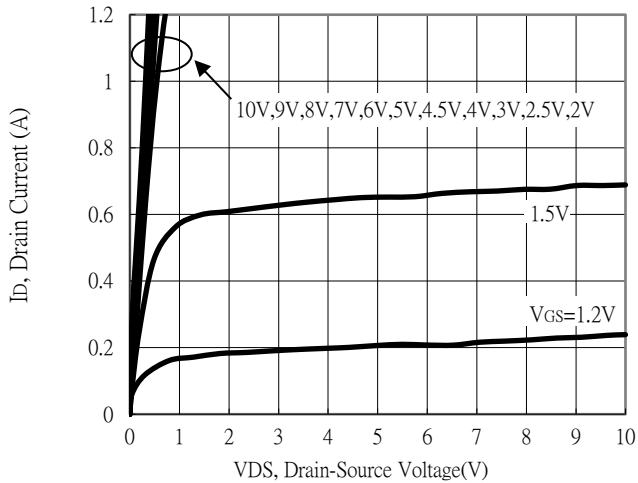

Breakdown Voltage vs Junction Temperature

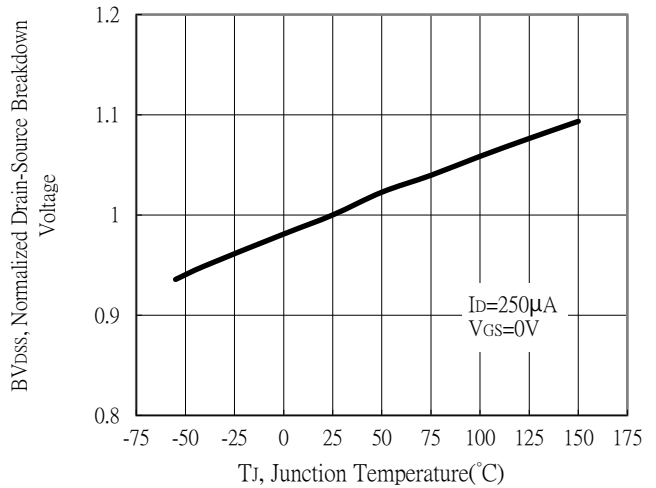

Static Drain-Source On-State resistance vs Drain Current

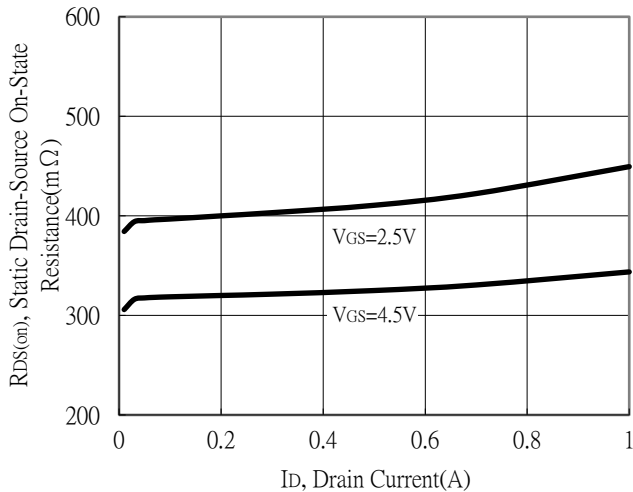

Body Diode Current vs Source-Drain Voltage

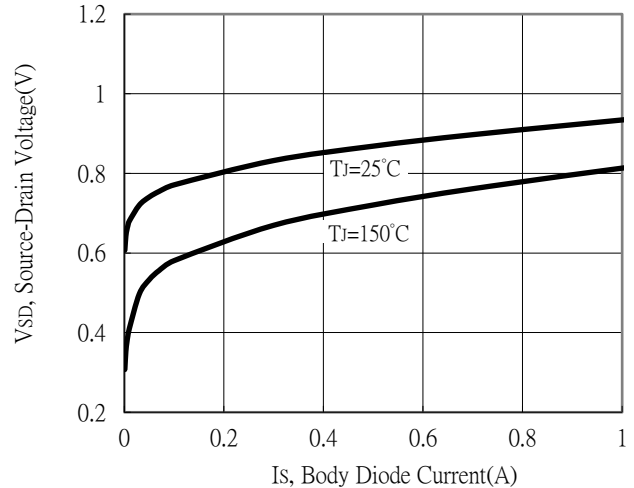

Static Drain-Source On-State Resistance vs Gate-Source Voltage

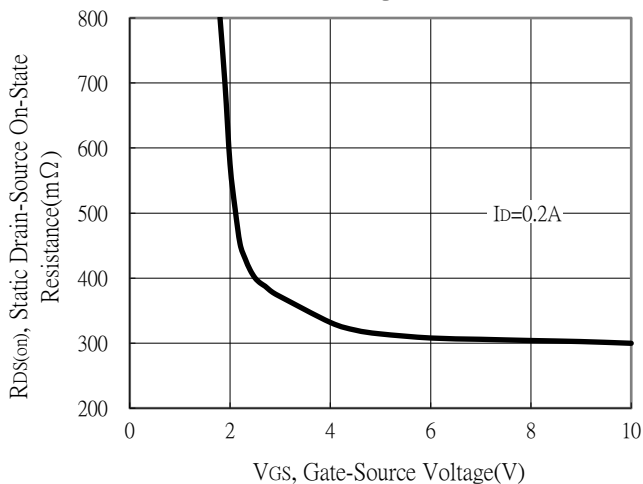

Drain-Source On-State Resistance vs Junction Temperature

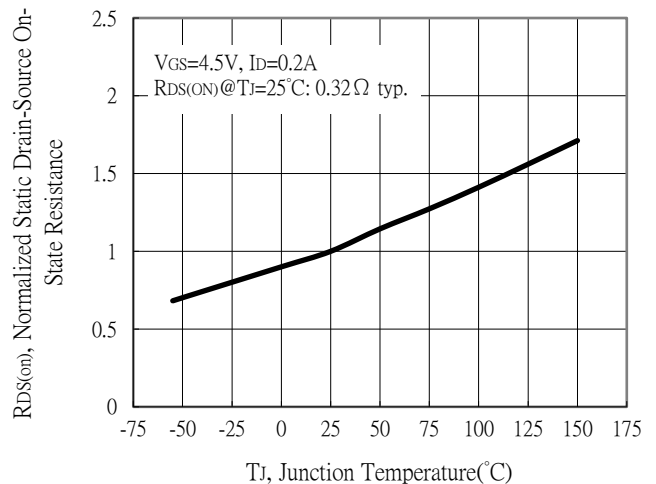



Typical Characteristics (Cont.)

Capacitance vs Drain-to-Source Voltage

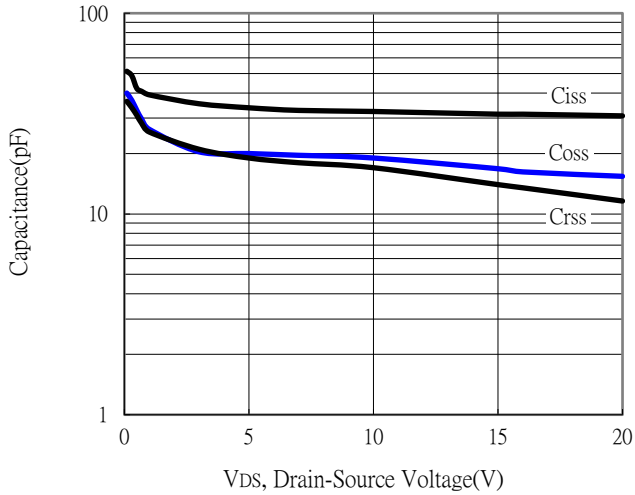

Threshold Voltage vs Junction Temperature

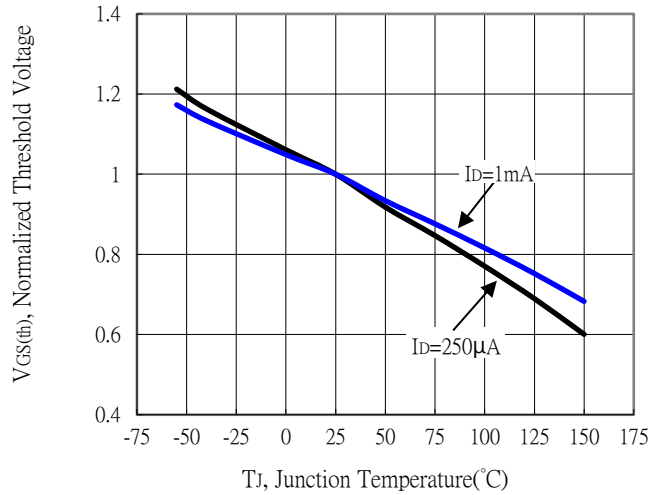

Forward Transfer Admittance vs Drain Current

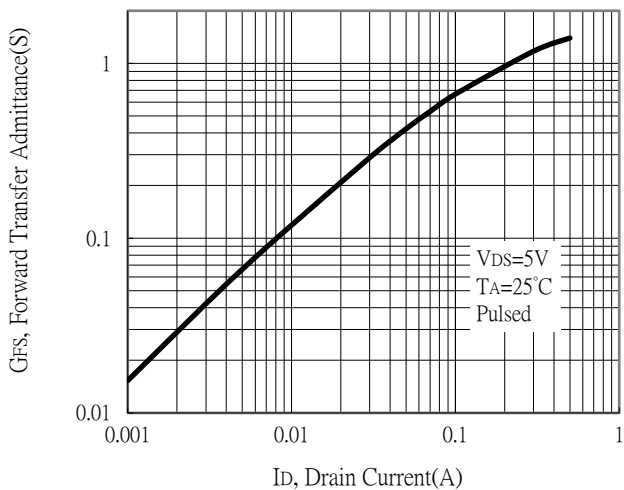

Gate Charge Characteristics

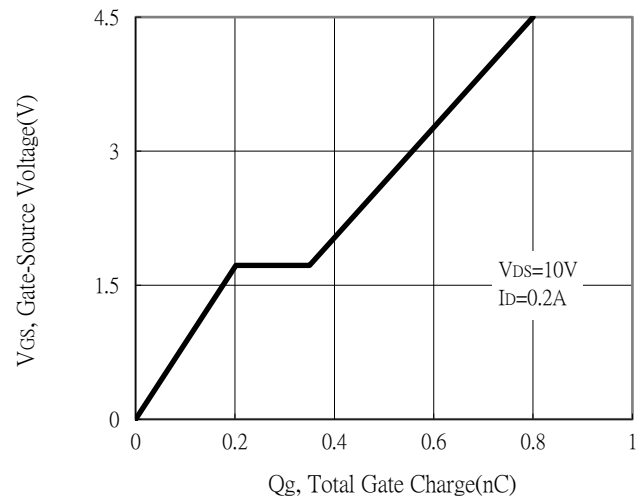

Maximum Safe Operating Area

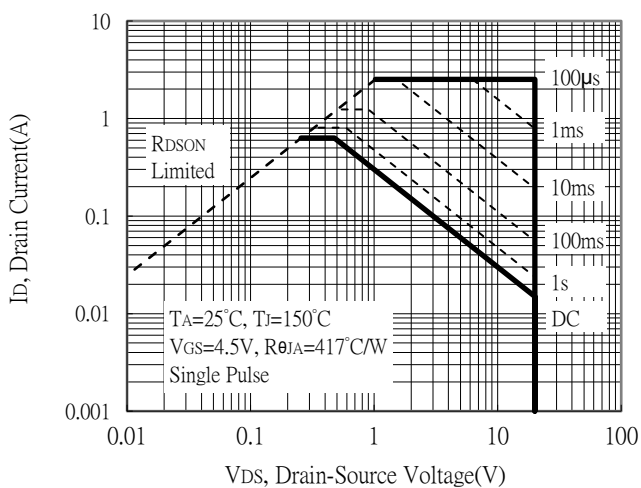

Maximum Drain Current vs Junction Temperature

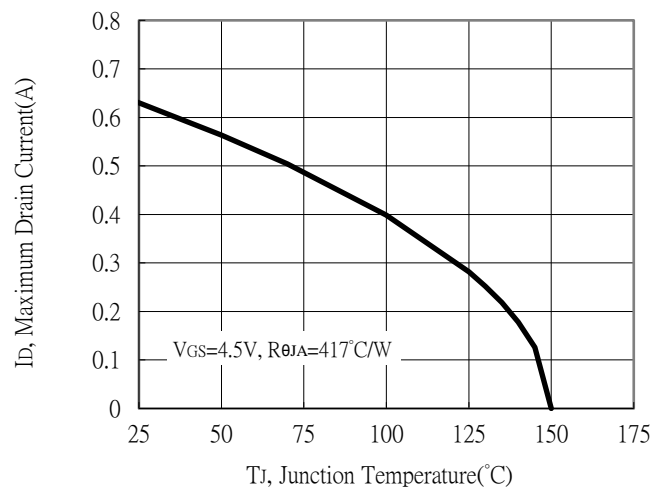

Typical Characteristics (Cont.)

Single Pulse Power Rating, Junction to Ambient

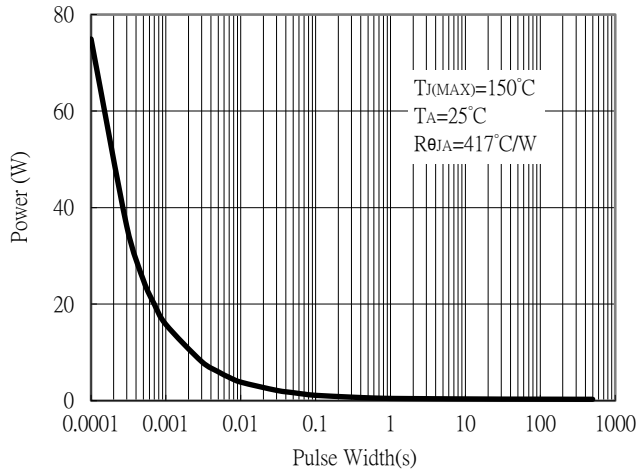

Transient Thermal Response Curves

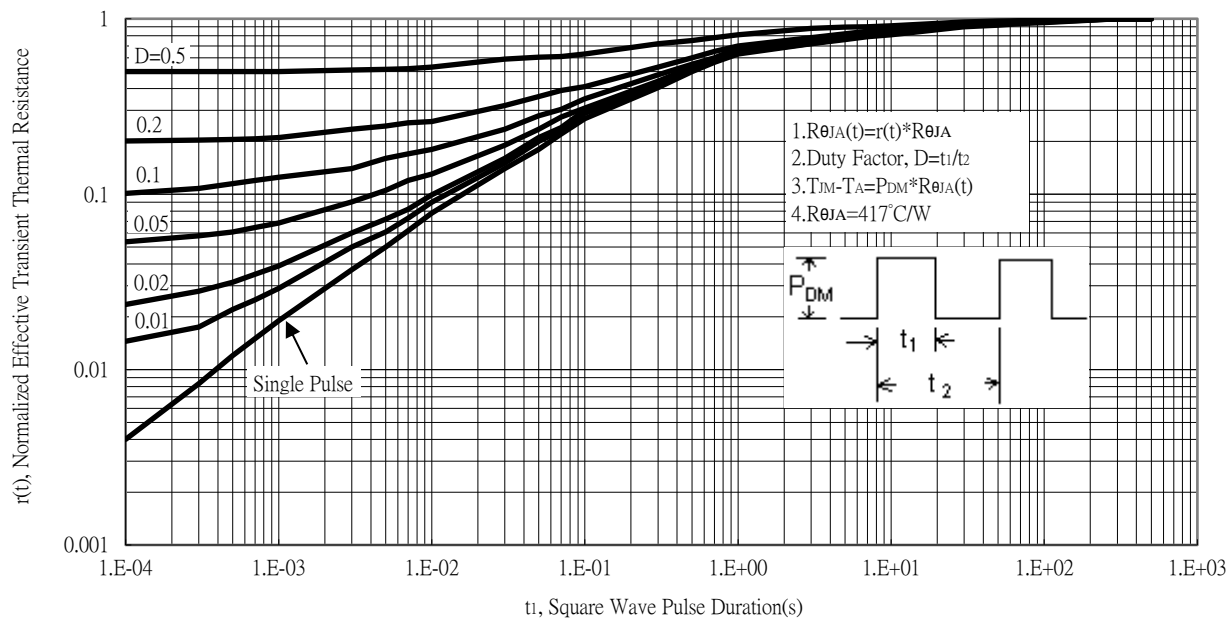

Recommended Soldering Footprint

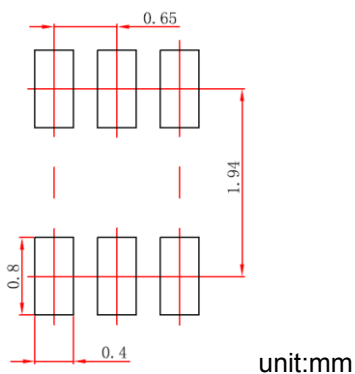

Reel Dimension

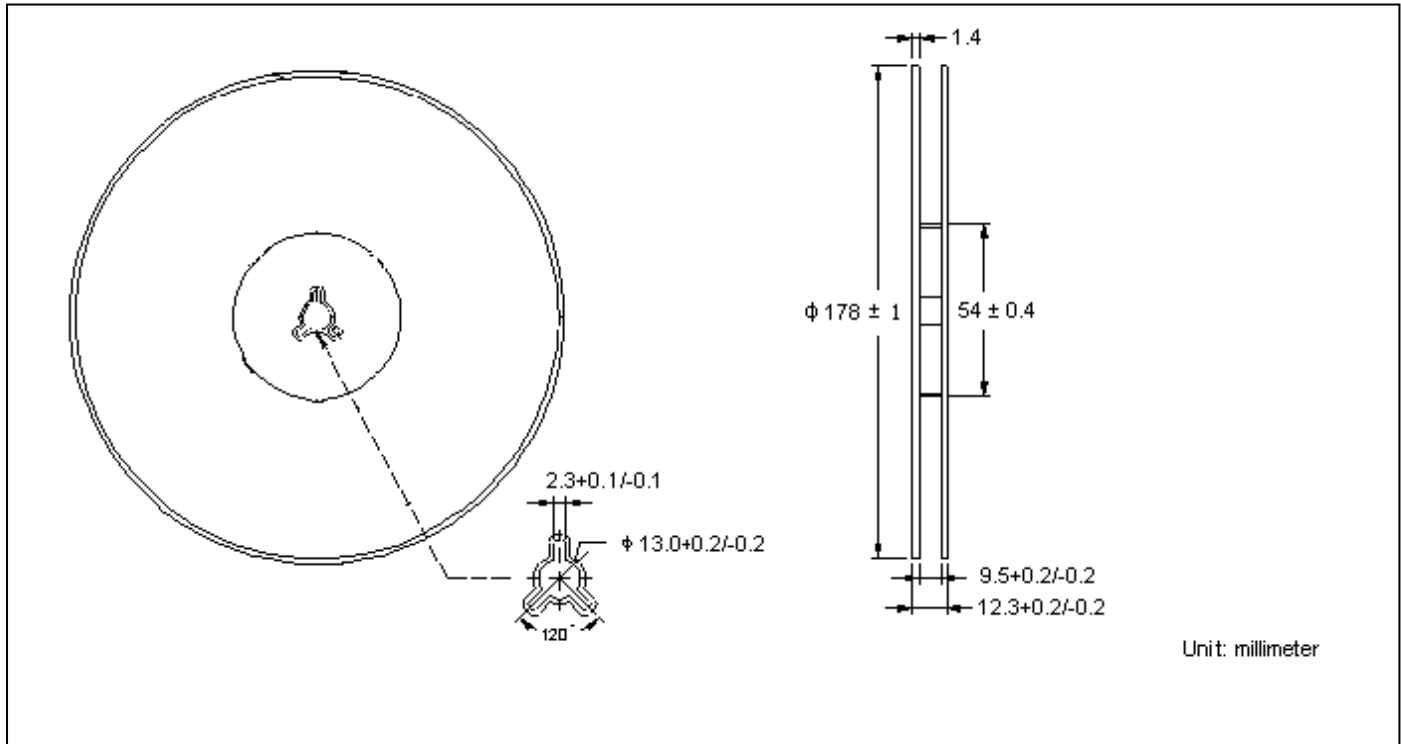

Carrier Tape Dimension

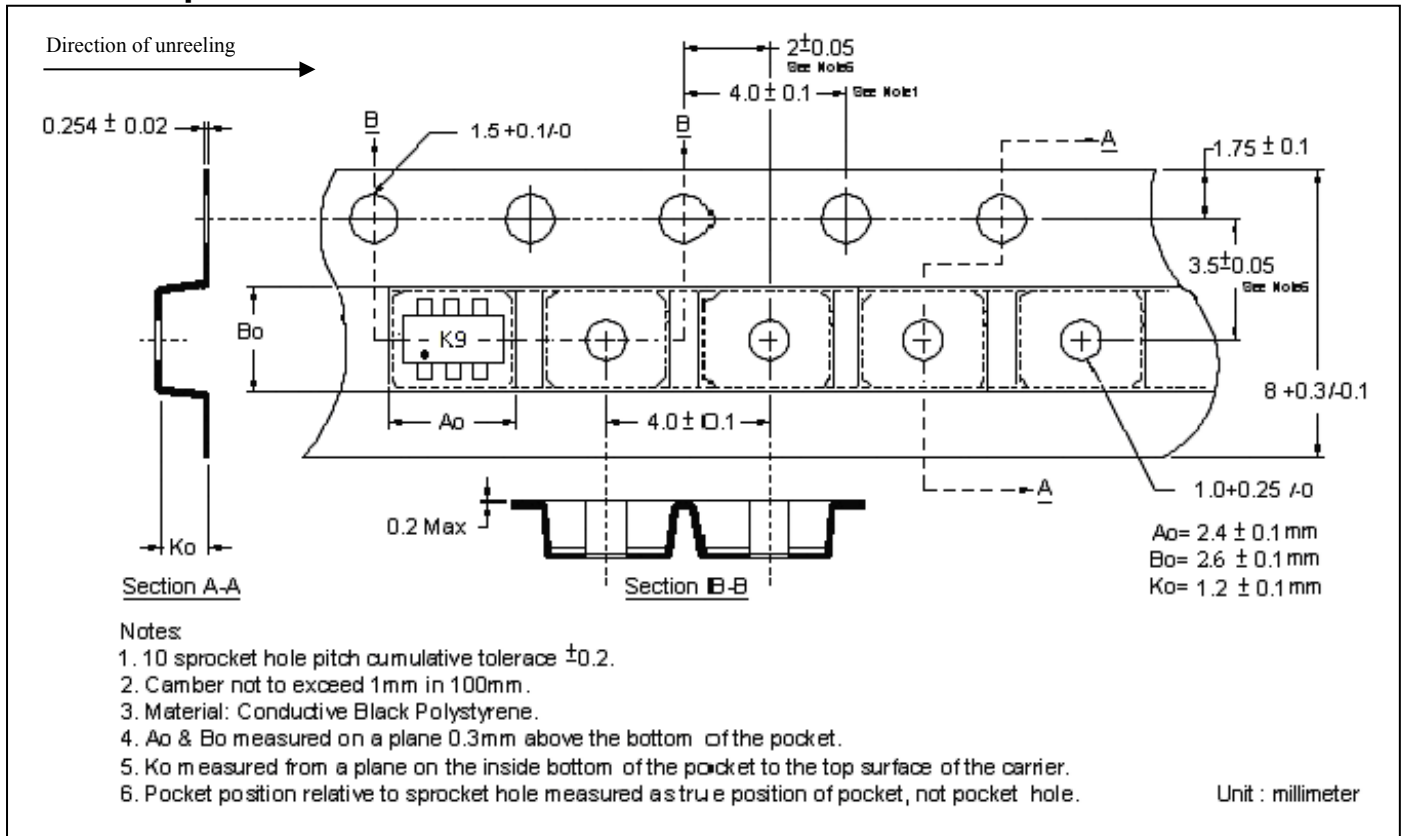

Recommended wave soldering condition

Product	Peak Temperature	Soldering Time
Pb-free devices	260 +0/-5 °C	5 +1/-1 seconds

Recommended temperature profile for IR reflow



Profile feature	Sn-Pb eutectic Assembly	Pb-free Assembly
Average ramp-up rate (Ts max to Tp)	3°C/second max.	3°C/second max.
Preheat		
-Temperature Min(Ts min)	100°C	150°C
-Temperature Max(Ts max)	150°C	200°C
-Time(ts min to ts max)	60-120 seconds	60-180 seconds
Time maintained above:		
-Temperature (Tl)	183°C	217°C
- Time (tL)	60-150 seconds	60-150 seconds
Peak Temperature(TP)	240 +0/-5 °C	260 +0/-5 °C
Time within 5°C of actual peak temperature(tp)	10-30 seconds	20-40 seconds
Ramp down rate	6°C/second max.	6°C/second max.
Time 25 °C to peak temperature	6 minutes max.	8 minutes max.

Note : All temperatures refer to topside of the package, measured on the package body surface.

SOT-363 Dimension

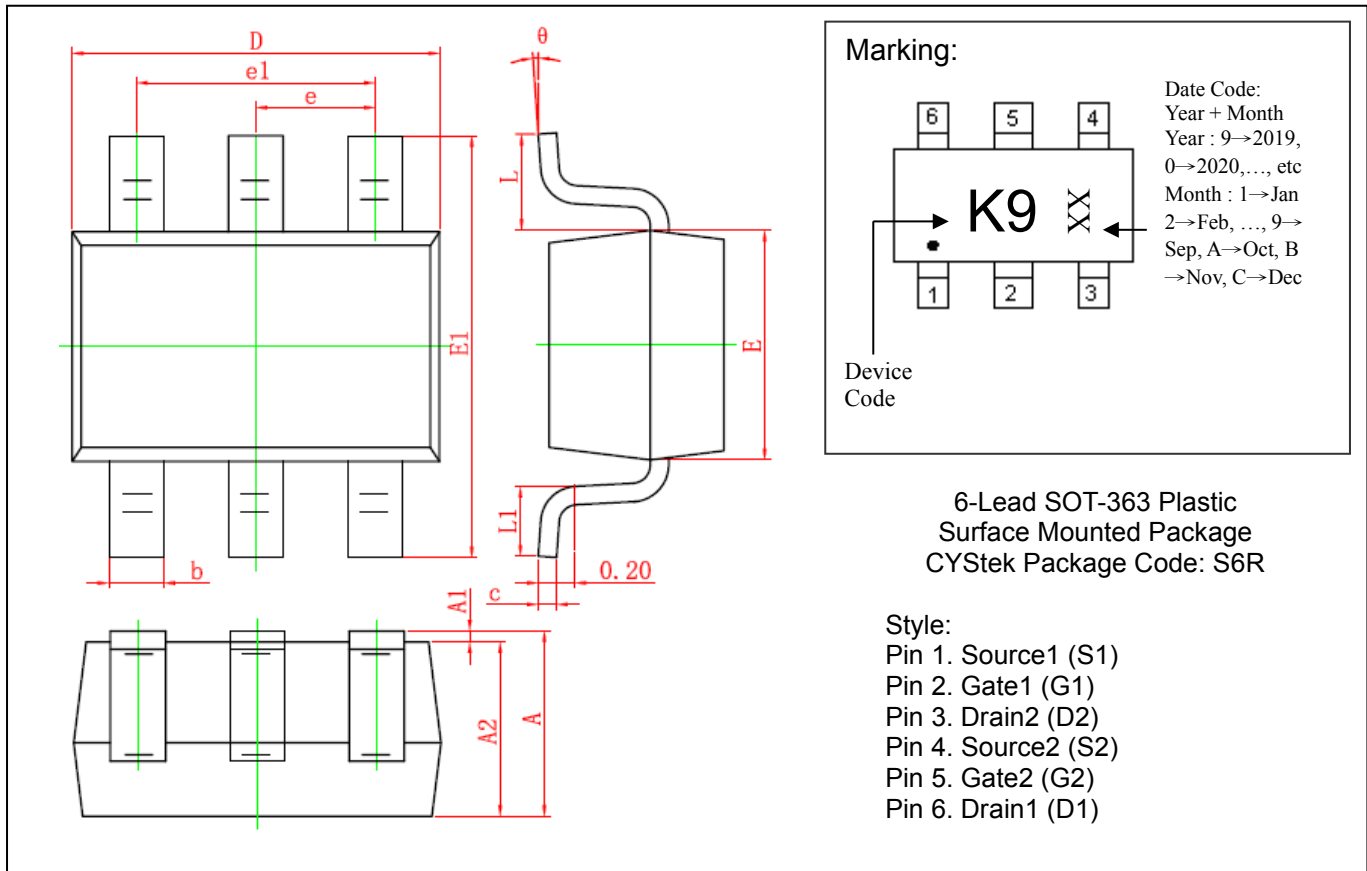

DIM	Millimeters		Inches		DIM	Millimeters		Inches	
	Min.	Max.	Min.	Max.		Min.	Max.	Min.	Max.
A	0.900	1.100	0.035	0.043	E1	2.150	2.450	0.085	0.096
A1	0.000	0.100	0.000	0.004	e	0.650	TYP	0.026	TYP
A2	0.900	1.000	0.035	0.039	e1	1.200	1.400	0.047	0.055
b	0.150	0.350	0.006	0.014	L	0.525	REF	0.021	REF
c	0.080	0.150	0.003	0.006	L1	0.260	0.460	0.010	0.018
D	2.000	2.200	0.079	0.087	θ	0°	8°	0°	8°
E	1.150	1.350	0.045	0.053					

Notes : 1.Controlling dimension : millimeters.
 2.Maximum lead thickness includes lead finish thickness, and minimum lead thickness is the minimum thickness of base material.
 3.If there is any question with packing specification or packing method, please contact your local CYStek sales office.

Material :

- Lead : Pure tin plated.
- Mold Compound : Epoxy resin family, flammability solid burning class:UL94V-0.

Important Notice:

- All rights are reserved. Reproduction in whole or in part is prohibited without the prior written approval of CYStek.
- CYStek reserves the right to make changes to its products without notice.
- CYStek **semiconductor products are not warranted to be suitable for use in Life-Support Applications, or systems.**
- CYStek assumes no liability for any consequence of customer product design, infringement of patents, or application assistance.