

ESD protected N-CHANNEL MOSFET

MTDK3S6R

BV_{DSS}	20V
$I_D @ V_{GS}=4.5V, T_A=25^\circ C$	100mA
$R_{DS(on)} @ V_{GS}=4.5V, I_D=100mA$	3Ω (max)

Description

- Low voltage drive, 1.8V
- Easy to use in parallel
- High speed switching
- ESD protected device
- Pb-free lead plating and halogen-free package

Symbol

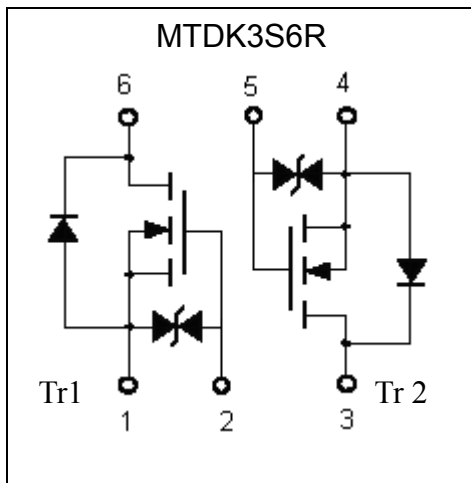

Outline

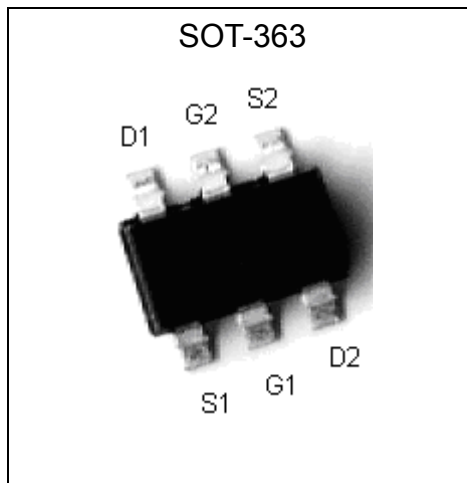

Ordering Information

Device	Package	Shipping
MTDK3S6R-0-T1-G	SOT-363 (Pb-free lead plating and halogen-free package)	3000 pcs / Tape & Reel

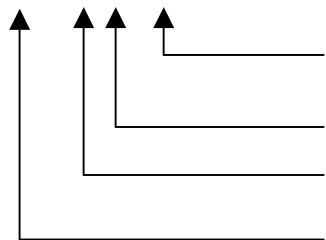

Environment friendly grade : S for RoHS compliant products, G for RoHS compliant and green compound products
 Packing spec, T1 : 3000 pcs / tape & reel, 7" reel
 Product rank, zero for no rank products
 Product name



The following characteristics apply to both Tr1 and Tr2
Absolute Maximum Ratings (Ta=25°C)

Parameter	Symbol	Limits	Unit
Drain-Source Voltage	BV _{DSS}	20	V
Gate-Source Voltage	V _{GS}	±8	
Continuous Drain Current @V _{GS} =4.5V, T _A =25°C	I _D	100	mA
Pulsed Drain Current (Ta=25°C)	I _{DM}	400 *1	
Total Power Dissipation	P _D	300 *2	mW
ESD susceptibility	V _{ESD}	350 *3	V
Operating Junction and Storage Temperature Range	T _j ; T _{stg}	-55~+150	°C
Thermal Resistance, Junction-to-Ambient	R _{th,ja}	415	°C/W

Note : *1. Pulse Width ≤ 300μs, Duty cycle ≤2%
 *2. 200mW per element must not be exceeded
 *3. Human body model, 1.5kΩ in series with 100pF

Electrical Characteristics (Ta=25°C)

Symbol	Min.	Typ.	Max.	Unit	Test Conditions
Static					
BV _{DSS}	20	-	-	V	V _{GS} =0V, I _D =100μA
V _{GS(th)}	0.5	-	1.0		V _{DS} =V _{GS} , I _D =250μA
I _{GSS}	-	-	±1	μA	V _{GS} =±8V, V _{DS} =0V
I _{DSS}	-	-	500	nA	V _{DS} =20V, V _{GS} =0V
R _{DS(ON)}	-	1.7	3	Ω	V _{GS} =4.5V, I _D =100mA
	-	3.5	6		V _{GS} =1.8V, I _D =20mA
G _{FS}	100	-	-	mS	V _{DS} =5V, I _D =100mA
Dynamic					
C _{iss}	-	23	50	pF	V _{DS} =10V, V _{GS} =0V, f=1MHz
C _{oss}	-	7.7	25		
C _{rss}	-	5.8	12		
Source-Drain Diode					
*V _{SD}	-	-	1	V	V _{GS} =0V, I _S =10mA

*Pulse Test : Pulse Width ≤300μs, Duty Cycle ≤2%



Typical Characteristics

Typical Output Characteristics

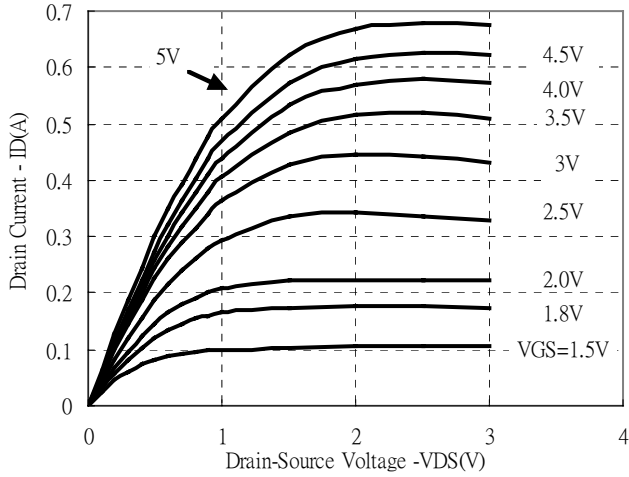

Typical Transfer Characteristics

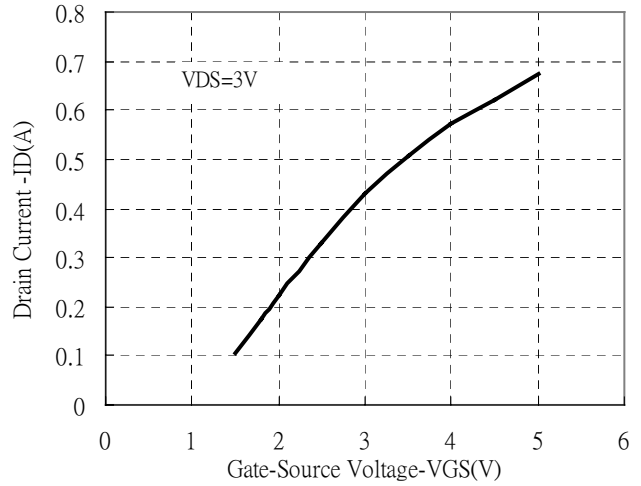

Static Drain-Source On-State resistance vs Drain Current

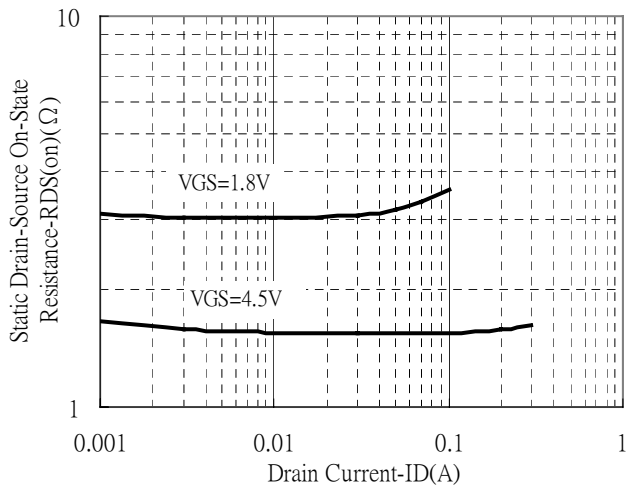

Static Drain-Source On-State Resistance vs Gate-Source Voltage

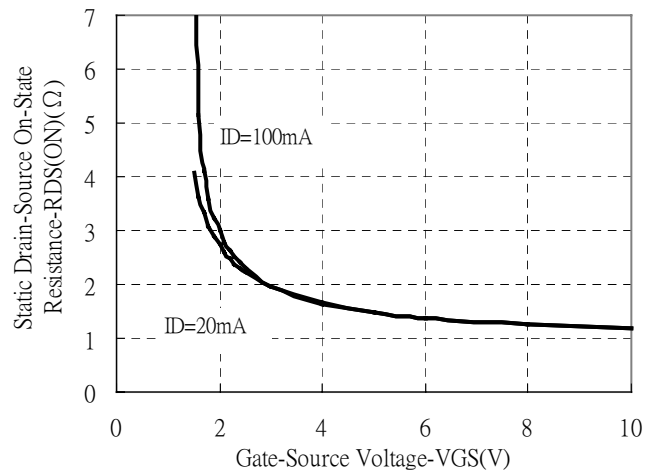

Reverse Drain Current vs Source-Drain Voltage

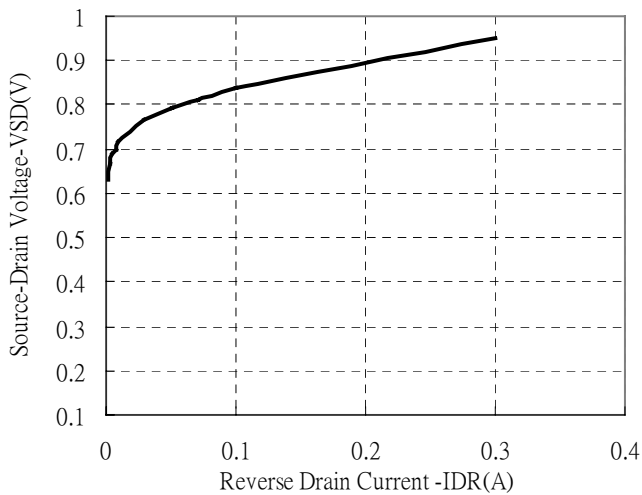

Capacitance vs Drain-to-Source Voltage

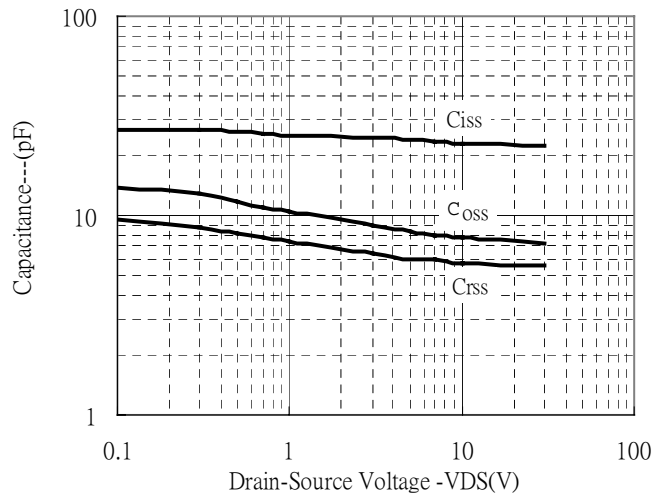



Typical Characteristics(Cont.)

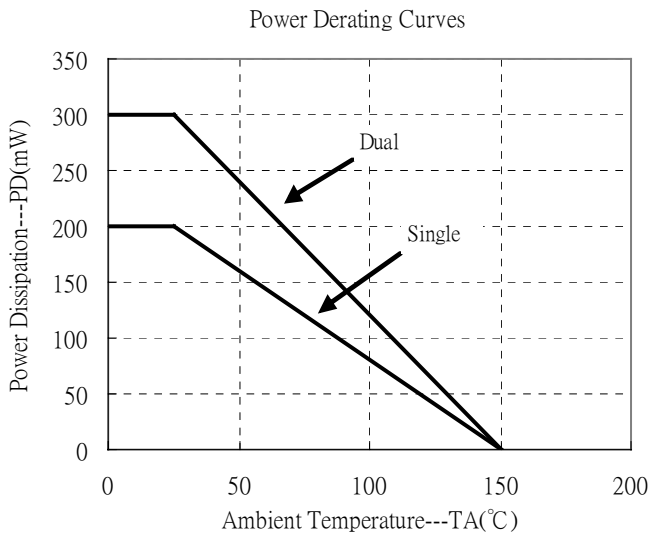

Reel Dimension

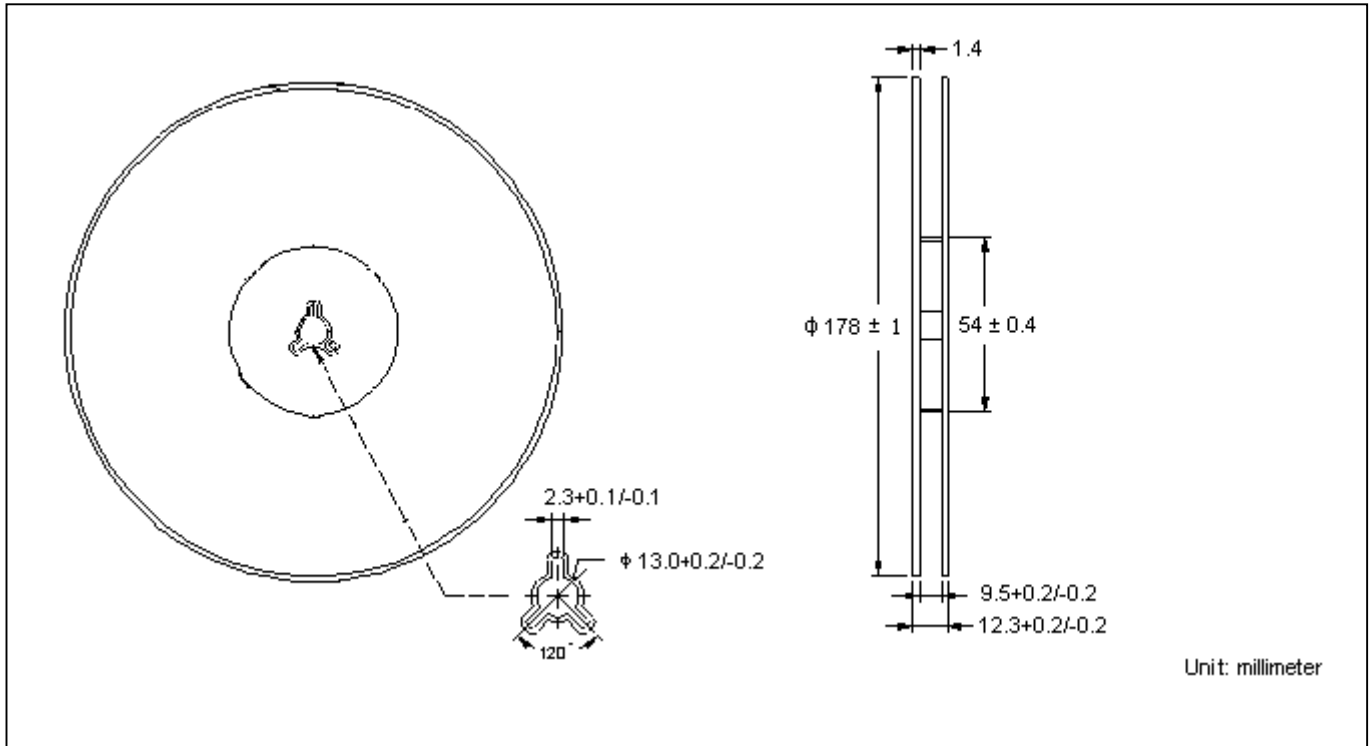

Carrier Tape Dimension

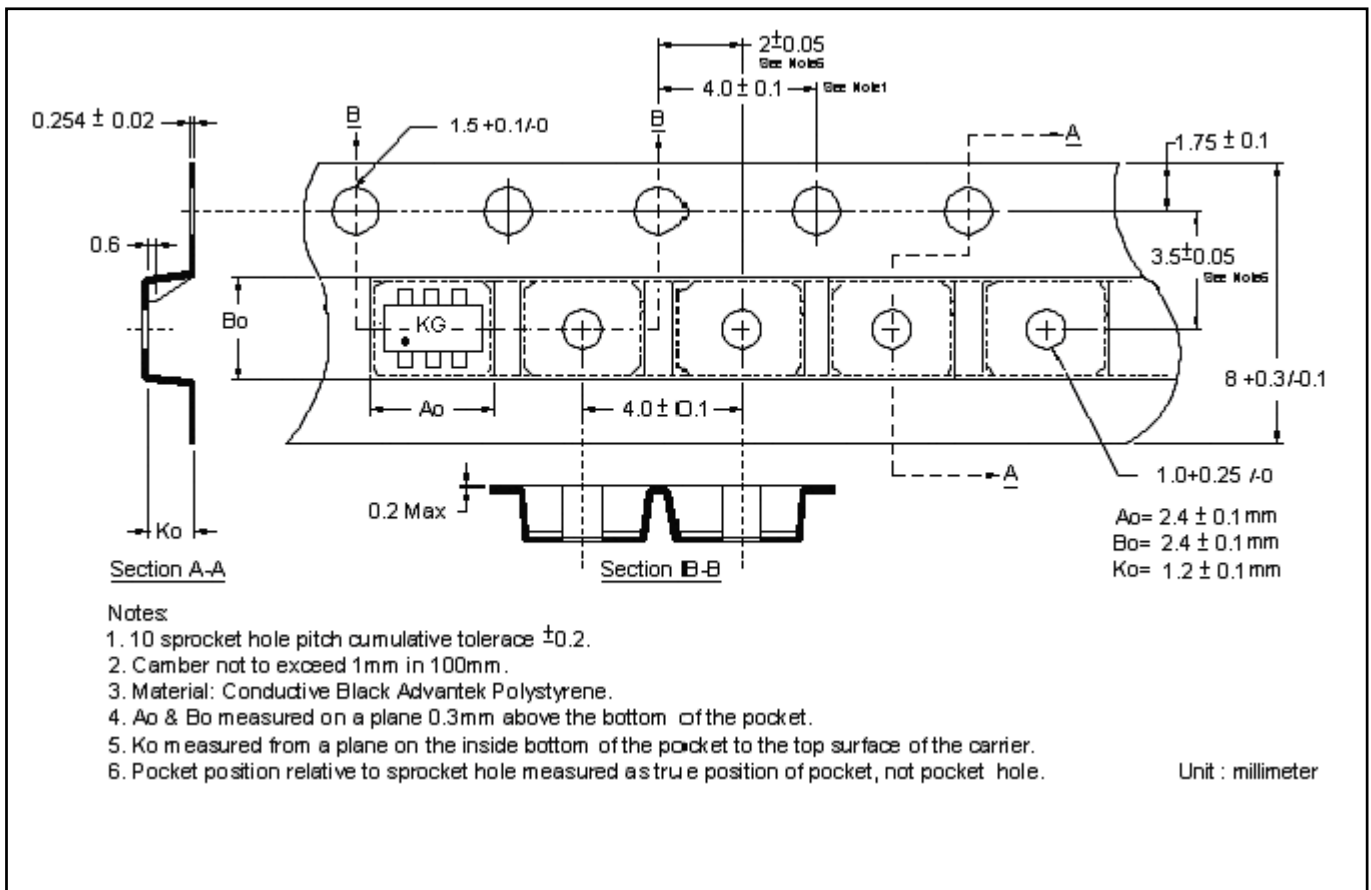

Recommended wave soldering condition

Product	Peak Temperature	Soldering Time
Pb-free devices	260 +0/-5 °C	5 +1/-1 seconds

Recommended temperature profile for IR reflow

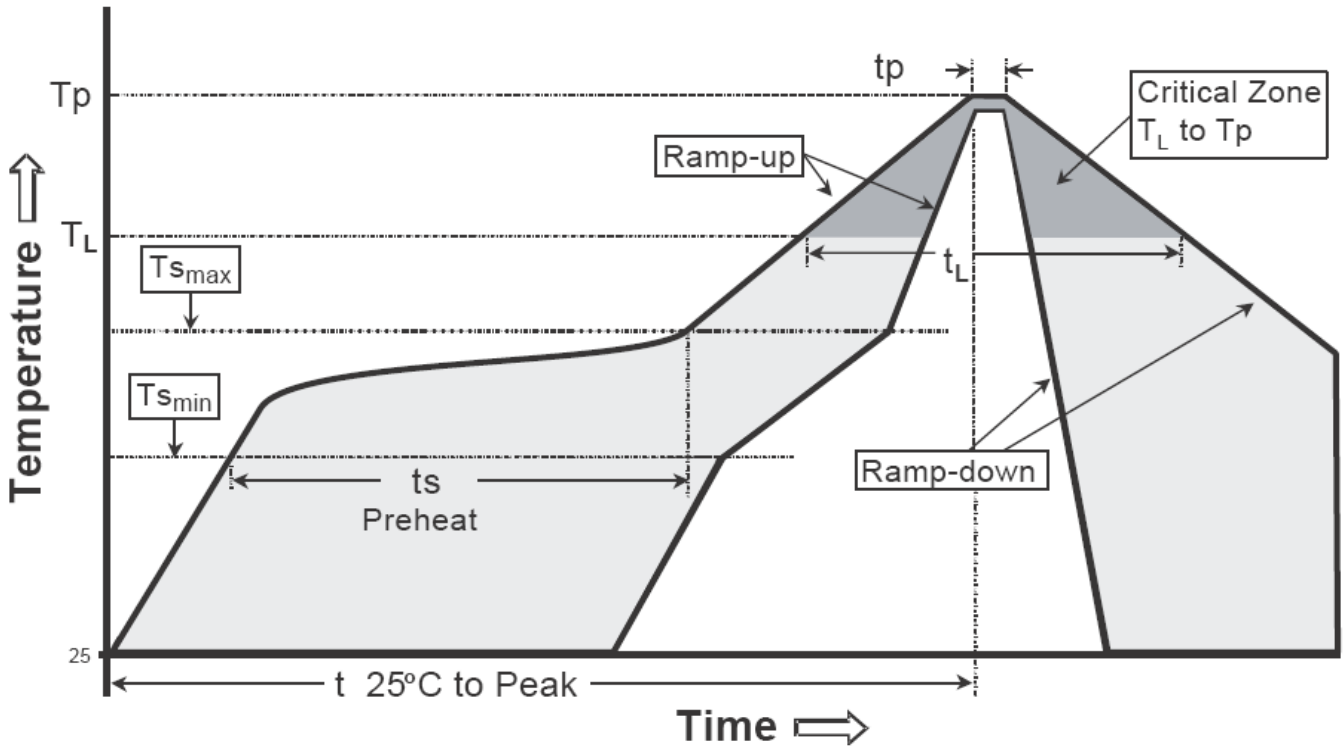

Profile feature	Sn-Pb eutectic Assembly	Pb-free Assembly
Average ramp-up rate (Tsmax to Tp)	3°C/second max.	3°C/second max.
Preheat		
-Temperature Min(Ts min)	100°C	150°C
-Temperature Max(Ts max)	150°C	200°C
-Time(ts min to ts max)	60-120 seconds	60-180 seconds
Time maintained above:		
-Temperature (TL)	183°C	217°C
- Time (tL)	60-150 seconds	60-150 seconds
Peak Temperature(TP)	240 +0/-5 °C	260 +0/-5 °C
Time within 5°C of actual peak temperature(tp)	10-30 seconds	20-40 seconds
Ramp down rate	6°C/second max.	6°C/second max.
Time 25 °C to peak temperature	6 minutes max.	8 minutes max.

Note : All temperatures refer to topside of the package, measured on the package body surface.

SOT-363 Dimension

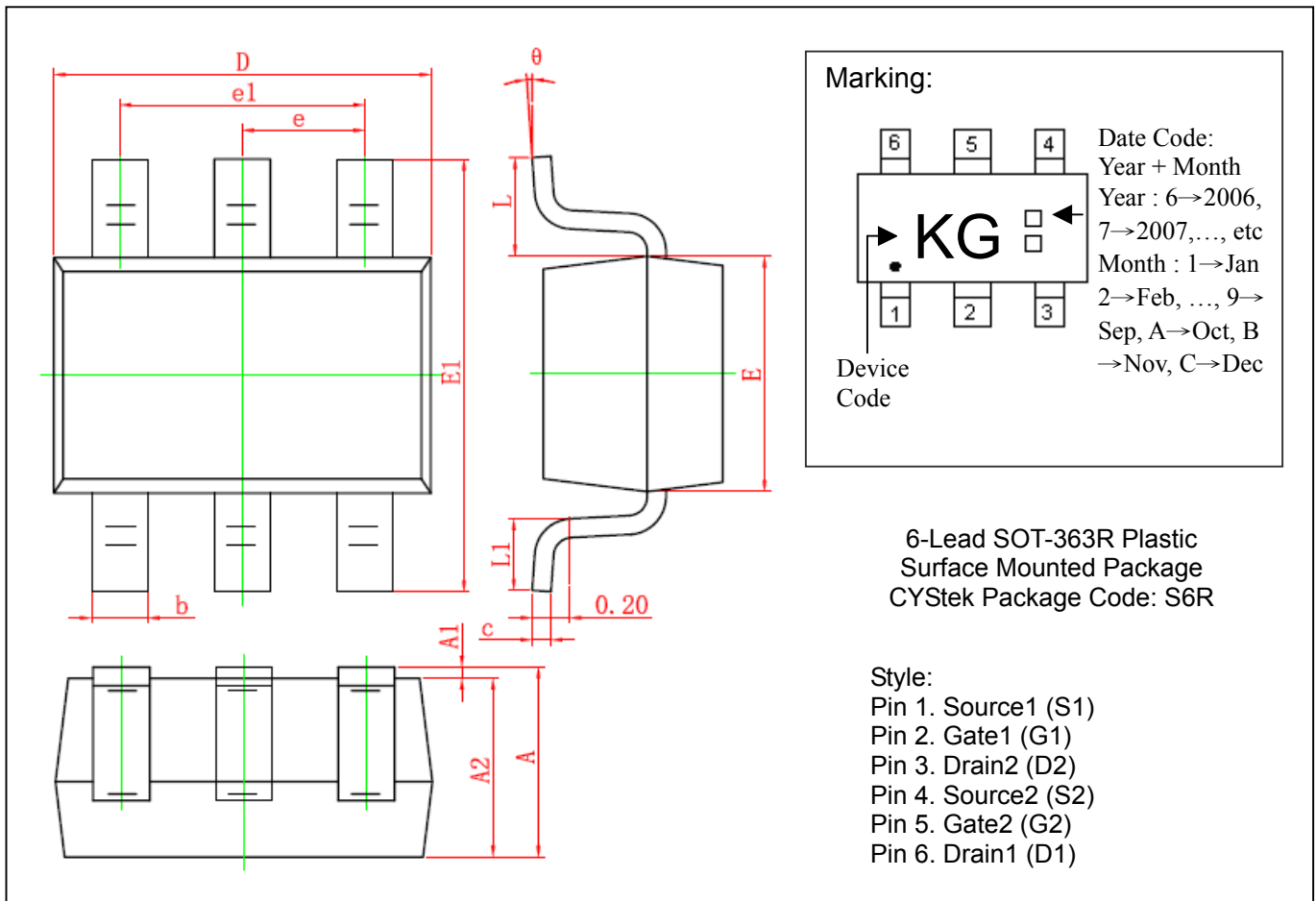

DIM	Millimeters		Inches		DIM	Millimeters		Inches	
	Min.	Max.	Min.	Max.		Min.	Max.	Min.	Max.
A	0.900	1.100	0.035	0.043	E1	2.150	2.450	0.085	0.096
A1	0.000	0.100	0.000	0.004	e	0.650	TYP	0.026	TYP
A2	0.900	1.000	0.035	0.039	e1	1.200	1.400	0.047	0.055
b	0.150	0.350	0.006	0.014	L	0.525	REF	0.021	REF
c	0.080	0.150	0.003	0.006	L1	0.260	0.460	0.010	0.018
D	2.000	2.200	0.079	0.087	θ	0°	8°	0°	8°
E	1.150	1.350	0.045	0.053					

Notes : 1.Controlling dimension : millimeters.
 2.Maximum lead thickness includes lead finish thickness, and minimum lead thickness is the minimum thickness of base material.
 3.If there is any question with packing specification or packing method, please contact your local CYStek sales office.

Material :

- Lead : Pure tin plated.
- Mold Compound : Epoxy resin family, flammability solid burning class:UL94V-0.

Important Notice:

- All rights are reserved. Reproduction in whole or in part is prohibited without the prior written approval of CYStek.
- CYStek reserves the right to make changes to its products without notice.
- CYStek **semiconductor products are not warranted to be suitable for use in Life-Support Applications, or systems.**
- CYStek assumes no liability for any consequence of customer product design, infringement of patents, or application assistance.