

**N-Channel Enhancement Mode Power MOSFET**

# MTD3D5N04E3

|   |       |
|---|-------|
| BV <sub>DSS</sub>   | 40V   |
| I <sub>D</sub> @ V <sub>GS</sub> =10V, T <sub>C</sub> =25°C           | 140A  |
| R <sub>DS(on)(TYP)</sub> @ V <sub>GS</sub> =10V, I <sub>D</sub> =75A  | 3.1mΩ |
| R <sub>DS(on)(TYP)</sub> @ V <sub>GS</sub> =4.5V, I <sub>D</sub> =20A | 5.0mΩ |

**Features**

- Low Gate Charge
- Simple Drive Requirement
- Repetitive Avalanche Rated
- Fast Switching Characteristic
- RoHS compliant package

**Symbol**

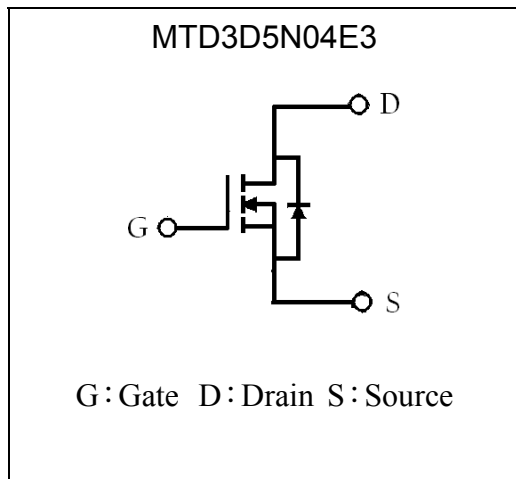

**Outline**

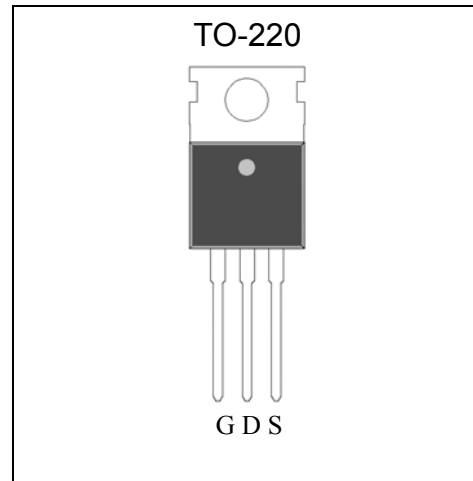

**Ordering Information**

| Device             | Package                                  | Shipping                                    |
|--------------------|--|---|
| MTD3D5N04E3-0-UB-S | TO-220<br>(Pb-free lead plating package) | 50 pcs/tube, 20 tubes/box, 4 boxes / carton |

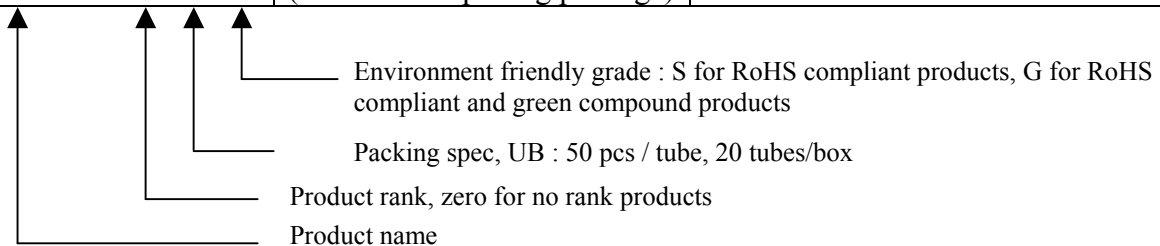

**Absolute Maximum Ratings** ( $T_C=25^{\circ}\text{C}$ , unless otherwise noted)

| Parameter   |                                    | Symbol         | Limits   | Unit               |
|---|------------------------------------|----------------|----------|--------------------|
| Drain-Source Voltage  |                                    | $V_{DS}$       | 40       | V                  |
| Gate-Source Voltage   |                                    | $V_{GS}$       | $\pm 20$ |                    |
| Continuous Drain Current @ $T_C=25^{\circ}\text{C}$ , $V_{GS}=10\text{V}$ (silicon limit) (Note 4)  |                                    | ID             | 140      | A                  |
| Continuous Drain Current @ $T_C=100^{\circ}\text{C}$ , $V_{GS}=10\text{V}$ (silicon limit) (Note 4) |                                    |                | 99       |                    |
| Continuous Drain Current @ $T_C=25^{\circ}\text{C}$ , $V_{GS}=10\text{V}$ (package limit) (Note 1)  |                                    |                | 75       |                    |
| Pulsed Drain Current (Note 3)   |                                    | $I_{DM}$       | 560      |                    |
| Continuous Drain Current @ $T_A=25^{\circ}\text{C}$ (Note 2)  |                                    | $I_{DSM}$      | 14.9     |                    |
| Continuous Drain Current @ $T_A=70^{\circ}\text{C}$ (Note 2)  |                                    |                | 11.9     |                    |
| Avalanche Current (Note 3)  |                                    | $I_{AS}$       | 32       |                    |
| Avalanche Energy @ $L=1\text{mH}$ , $I_D=32\text{A}$ , $R_G=25\Omega$ (Note 2)                      |                                    | $E_{AS}$       | 512      | mJ                 |
| Repetitive Avalanche Energy @ $L=0.1\text{mH}$ (Note 3)   |                                    | $E_{AR}$       | 20       |                    |
| Power Dissipation   | $T_C=25^{\circ}\text{C}$ (Note 1)  | PD             | 200      | W                  |
|   | $T_C=100^{\circ}\text{C}$ (Note 1) |                | 100      |                    |
| Power Dissipation   | $T_A=25^{\circ}\text{C}$ (Note 2)  | PDSM           | 2        | W                  |
|   | $T_A=70^{\circ}\text{C}$ (Note 2)  |                | 1.3      |                    |
| Operating Junction and Storage Temperature  |                                    | $T_j, T_{stg}$ | -55~+175 | $^{\circ}\text{C}$ |

**Thermal Data**

| Parameter  | Symbol       | Value | Unit                        |
|--|--------------|-------|-----------------------------|
| Thermal Resistance, Junction-to-case, max                                  | $R_{th,j-c}$ | 0.75  | $^{\circ}\text{C}/\text{W}$ |
| Thermal Resistance, Junction-to-ambient, max, $t \leq 10\text{s}$ (Note 1) | $R_{th,j-a}$ | 15    | $^{\circ}\text{C}/\text{W}$ |
| Thermal Resistance, Junction-to-ambient, max (Note 1)                      |              | 62.5  | $^{\circ}\text{C}/\text{W}$ |

- Note : 1. The power dissipation  $P_D$  is based on  $T_{J(MAX)}=175^{\circ}\text{C}$ , using junction-to-case thermal resistance, and is more useful in setting the upper dissipation limit for cases where additional heatsinking is used.
2. The value of  $R_{\theta JA}$  is measured with the device mounted on 1 in<sup>2</sup> FR-4 board with 2 oz. copper, in a still air environment with  $T_A=25^{\circ}\text{C}$ . The power dissipation  $P_{DSM}$  is based on  $R_{\theta JA}$  and the maximum allowed junction temperature of  $150^{\circ}\text{C}$ . The value in any given application depends on the user's specific board design, and the maximum temperature of  $175^{\circ}\text{C}$  may be used if the PCB allows it.
3. Repetitive rating, pulse width limited by junction temperature  $T_{J(MAX)}=175^{\circ}\text{C}$ . Ratings are based on low frequency and low duty cycles to keep initial  $T_J=25^{\circ}\text{C}$ .
4. Calculated continuous drain current based on maximum allowable junction temperature.
5. The maximum current limited by package is 75A.
6. The static characteristics are obtained using  $<300\mu\text{s}$  pulses, duty cycle 0.5% maximum.
7. The  $R_{\theta JA}$  is the sum of thermal resistance from junction to case  $R_{\theta JC}$  and case to ambient.



**Characteristics (Tc=25°C, unless otherwise specified)**

| Symbol                    | Min. | Typ. | Max. | Unit | Test Conditions  |
|---------------------------|------|------|------|------|--|
| <b>Static</b>             |      |      |      |      |  |
| BV <sub>DSS</sub>         | 40   | -    | -    | V    | V <sub>GS</sub> =0V, I <sub>D</sub> =250μA   |
| V <sub>GS(th)</sub>       | 1.5  | -    | 2.5  |      | V <sub>DS</sub> = V <sub>GS</sub> , I <sub>D</sub> =250μA                                |
| G <sub>FS</sub>           | -    | 46   | -    | S    | V <sub>DS</sub> =5V, I <sub>D</sub> =20A   |
| I <sub>GSS</sub>          | -    | -    | ±100 | nA   | V <sub>GS</sub> =±20V  |
| I <sub>DSS</sub>          | -    | -    | 1    | μA   | V <sub>DS</sub> =40V, V <sub>GS</sub> =0V  |
|                           | -    | -    | 10   |      | V <sub>DS</sub> =40V, V <sub>GS</sub> =0V, T <sub>j</sub> =55°C                          |
| *R <sub>DS(ON)</sub>      | -    | 3.1  | 4.0  | mΩ   | V <sub>GS</sub> =10V, I <sub>D</sub> =75A  |
|                           | -    | 5.0  | 6.5  |      | V <sub>GS</sub> =4.5V, I <sub>D</sub> =20A   |
| <b>Dynamic</b>            |      |      |      |      |  |
| *Q <sub>g</sub>           | -    | 68.3 | -    | nC   | I <sub>D</sub> =95A, V <sub>DS</sub> =32V, V <sub>GS</sub> =10V                          |
| *Q <sub>gs</sub>          | -    | 13.2 | -    |      |  |
| *Q <sub>gd</sub>          | -    | 23.1 | -    |      |  |
| *t <sub>d(ON)</sub>       | -    | 22.2 | -    | ns   | V <sub>DS</sub> =20V, I <sub>D</sub> =95A, V <sub>GS</sub> =10V,<br>R <sub>G</sub> =2.5Ω |
| *t <sub>r</sub>           | -    | 20.2 | -    |      |  |
| *t <sub>d(OFF)</sub>      | -    | 55.6 | -    |      |  |
| *t <sub>f</sub>           | -    | 11.8 | -    |      |  |
| C <sub>iss</sub>          | -    | 2992 | -    | pF   | V <sub>GS</sub> =0V, V <sub>DS</sub> =25V, f=1MHz  |
| C <sub>oss</sub>          | -    | 375  | -    |      |  |
| C <sub>rss</sub>          | -    | 228  | -    |      |  |
| <b>Source-Drain Diode</b> |      |      |      |      |  |
| *I <sub>S</sub>           | -    | -    | 140  | A    | (Silicon limit)  |
| *I <sub>S</sub>           | -    | -    | 560  |      |  |
| *V <sub>SD</sub>          | -    | 0.91 | 1.2  | V    | I <sub>S</sub> =75A, V <sub>GS</sub> =0V   |
| *t <sub>rr</sub>          | -    | 19   | -    | ns   | I <sub>F</sub> =95A, V <sub>GS</sub> =0, dI <sub>F</sub> /dt=100A/μs                     |
| *Q <sub>rr</sub>          | -    | 11   | -    | nC   |  |

\*Pulse Test : Pulse Width ≤300μs, Duty Cycle≤2%



**Typical Characteristics**

Typical Output Characteristics

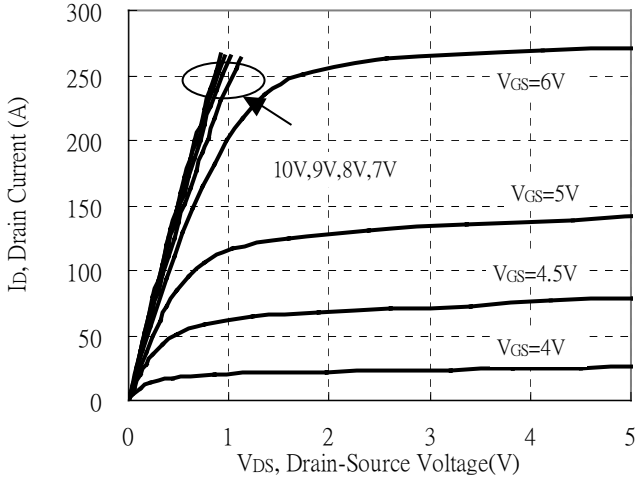

Brekdown Voltage vs Ambient Temperature

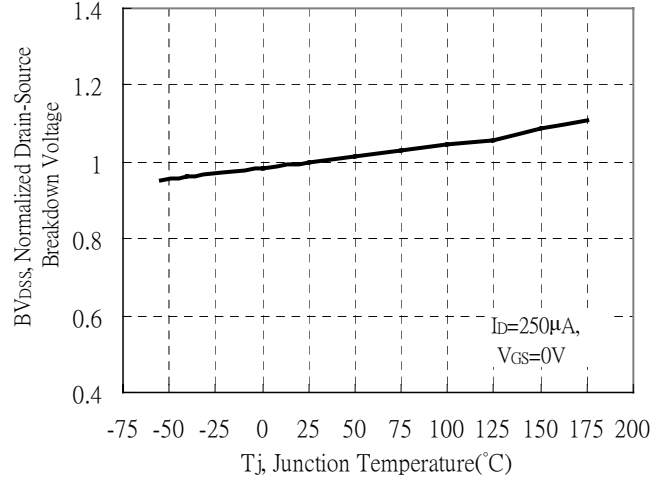

Static Drain-Source On-State resistance vs Drain Current

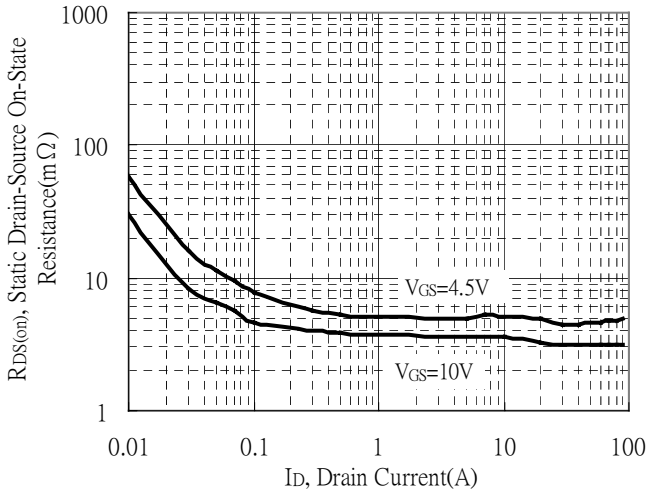

Reverse Drain Current vs Source-Drain Voltage

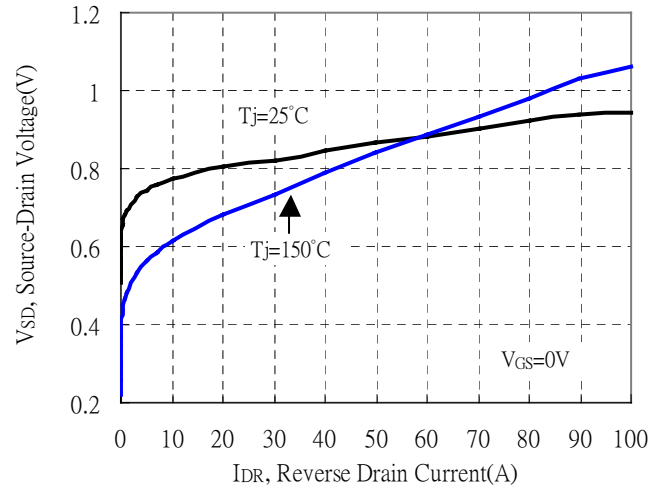

Static Drain-Source On-State Resistance vs Gate-Source Voltage

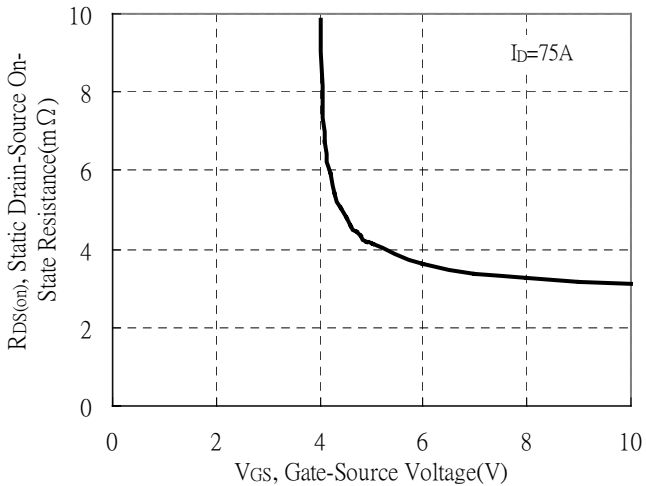

Drain-Source On-State Resistance vs Junction Temperature

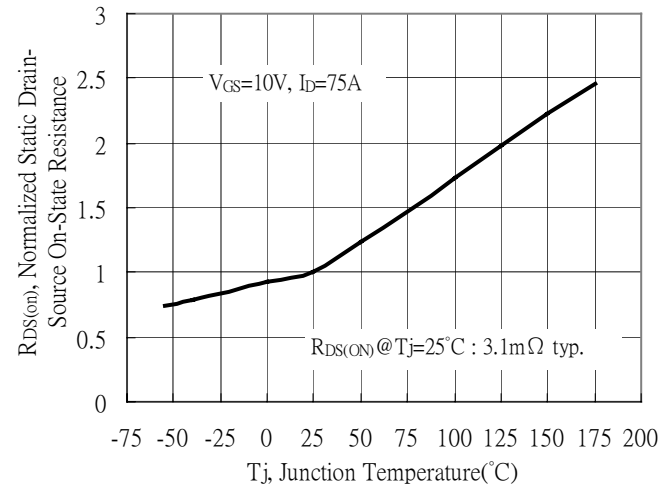



**Typical Characteristics(Cont.)**

Capacitance vs Drain-to-Source Voltage

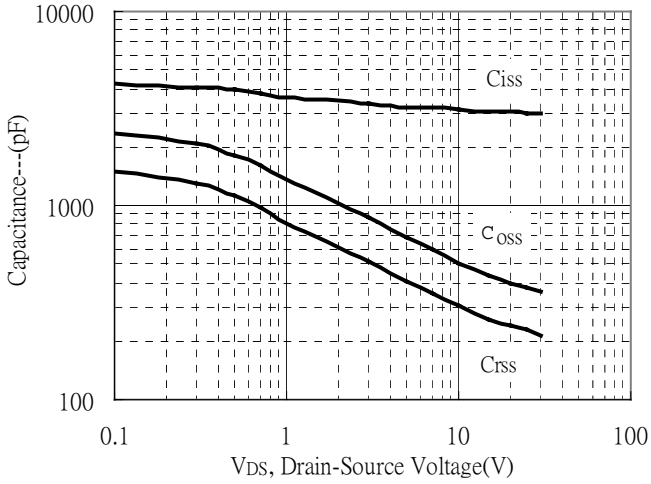

Threshold Voltage vs Junction Temperature

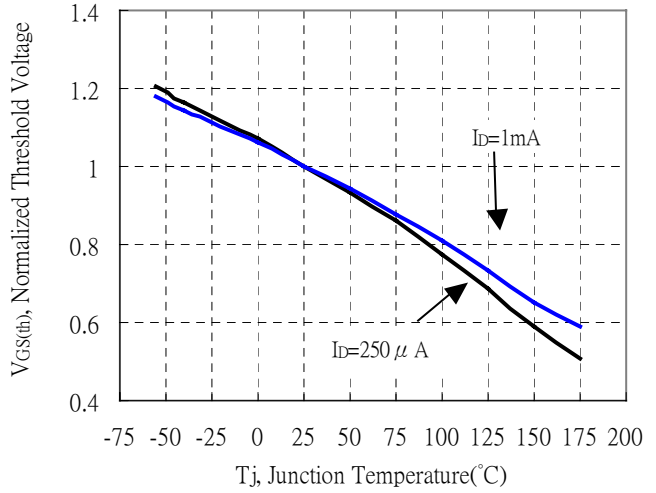

Forward Transfer Admittance vs Drain Current

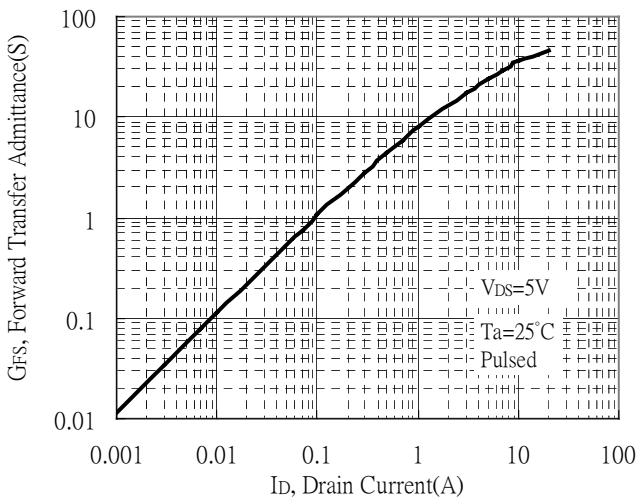

Gate Charge Characteristics

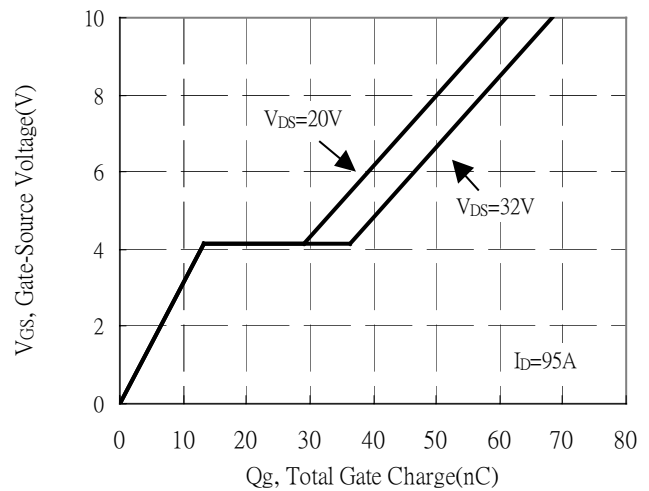

Maximum Safe Operating Area

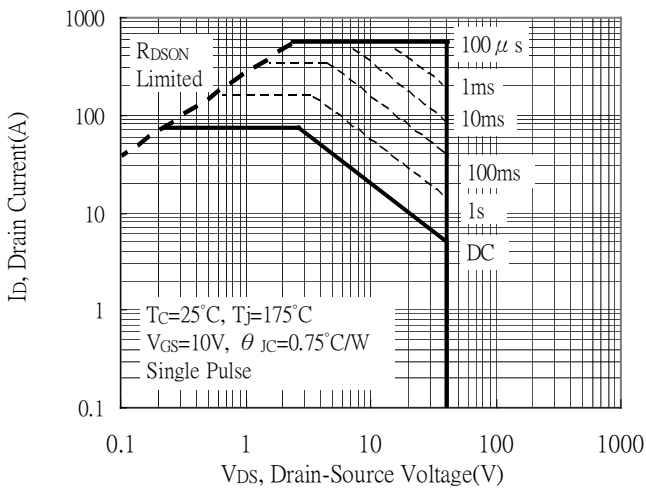

Maximum Drain Current vs Case Temperature

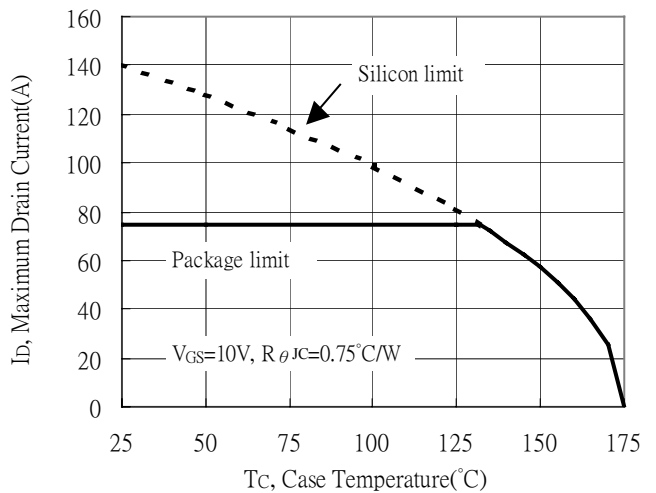

**Typical Characteristics(Cont.)**

Typical Transfer Characteristics

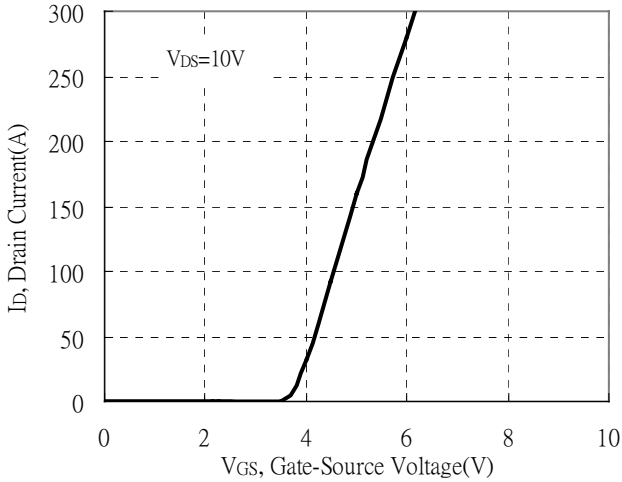

Single Pulse Power Rating, Junction to Case

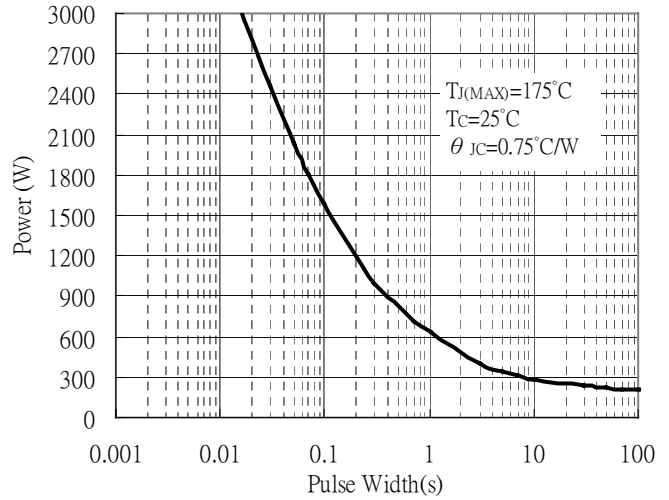

Transient Thermal Response Curves

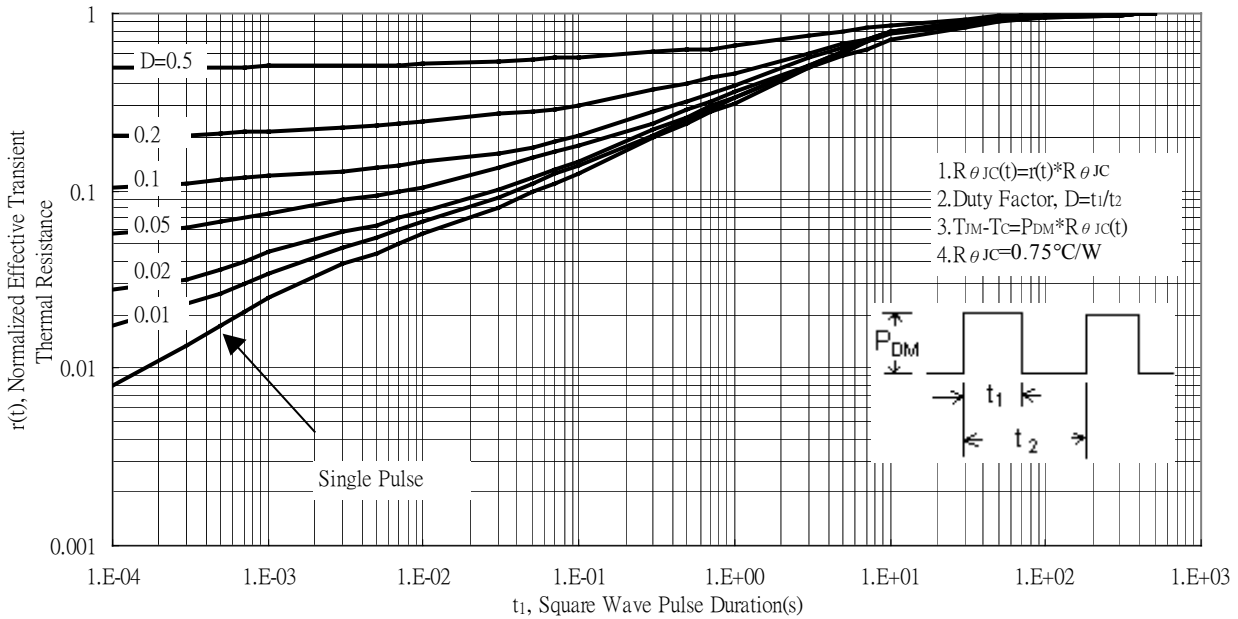

**Recommended wave soldering condition**

|                 |                  |                 |
|-----------------|------------------|-----------------|
| Product         | Peak Temperature | Soldering Time  |
| Pb-free devices | 260 +0/-5 °C     | 5 +1/-1 seconds |

**Recommended temperature profile for IR reflow**

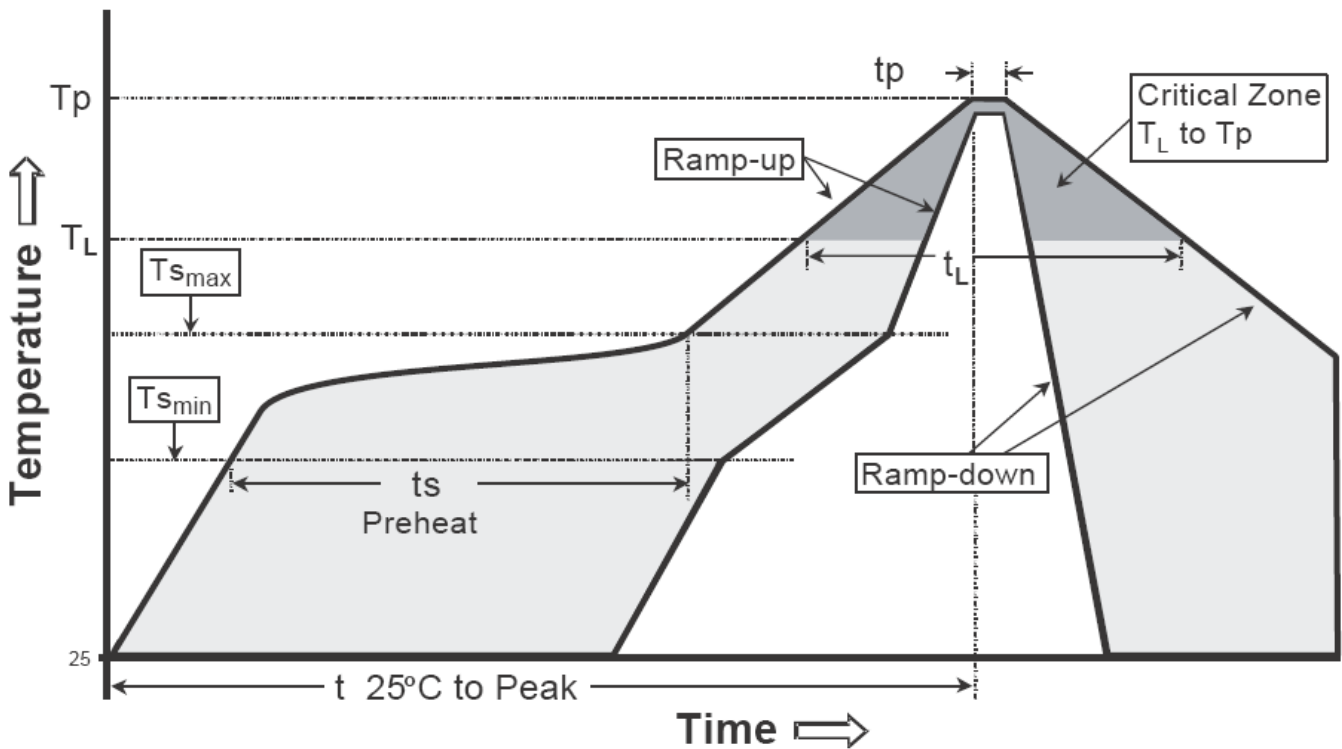

| Profile feature                                     | Sn-Pb eutectic Assembly | Pb-free Assembly |
|---|-------------------------|------------------|
| Average ramp-up rate ( $T_{s_{max}}$ to $T_p$ )     | 3°C/second max.         | 3°C/second max.  |
| Preheat   |                         |                  |
| -Temperature Min( $T_{s_{min}}$ )                   | 100°C                   | 150°C            |
| -Temperature Max( $T_{s_{max}}$ )                   | 150°C                   | 200°C            |
| -Time( $t_{s_{min}}$ to $t_{s_{max}}$ )             | 60-120 seconds          | 60-180 seconds   |
| Time maintained above:                              |                         |                  |
| -Temperature ( $T_L$ )                              | 183°C                   | 217°C            |
| - Time ( $t_L$ )                                    | 60-150 seconds          | 60-150 seconds   |
| Peak Temperature( $T_P$ )                           | 240 +0/-5 °C            | 260 +0/-5 °C     |
| Time within 5°C of actual peak temperature( $t_p$ ) | 10-30 seconds           | 20-40 seconds    |
| Ramp down rate                                      | 6°C/second max.         | 6°C/second max.  |
| Time 25 °C to peak temperature                      | 6 minutes max.          | 8 minutes max.   |

Note : All temperatures refer to topside of the package, measured on the package body surface.

**TO-220 Dimension**

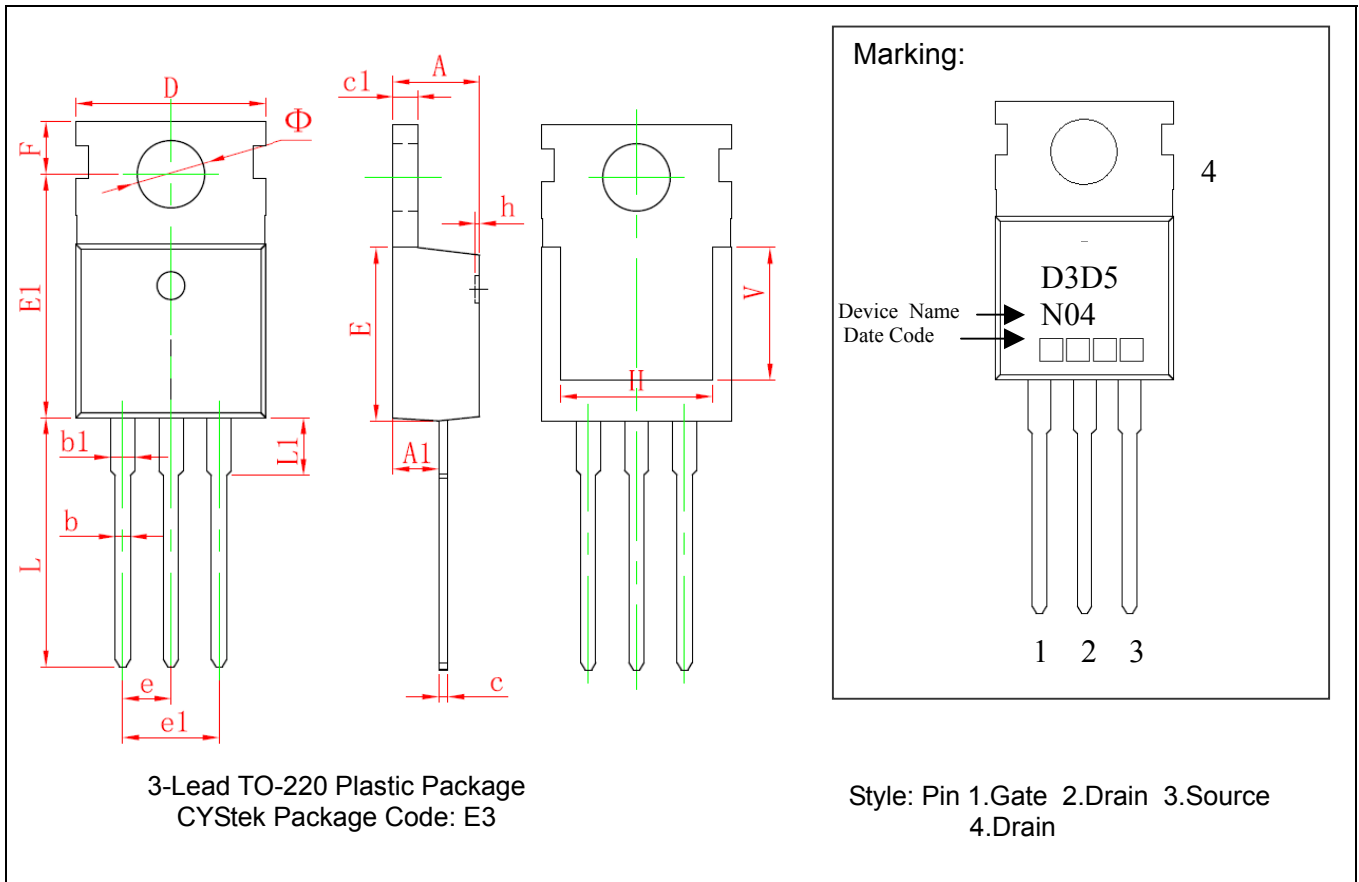

\*: Typical

| DIM | Millimeters |        | Inches |       | DIM | Millimeters |        | Inches |       |
|-----|-------------|--------|--------|-------|-----|-------------|--------|--------|-------|
|     | Min.        | Max.   | Min.   | Max.  |     | Min.        | Max.   | Min.   | Max.  |
| A   | 4.400       | 4.600  | 0.173  | 0.181 | e   | 2.540*      |        | 0.100* |       |
| A1  | 2.250       | 2.550  | 0.089  | 0.100 | e1  | 4.980       | 5.180  | 0.196  | 0.204 |
| b   | 0.710       | 0.910  | 0.028  | 0.036 | F   | 2.650       | 2.950  | 0.104  | 0.116 |
| b1  | 1.170       | 1.370  | 0.046  | 0.054 | H   | 7.900       | 8.100  | 0.311  | 0.319 |
| c   | 0.330       | 0.650  | 0.013  | 0.026 | h   | 0.000       | 0.300  | 0.000  | 0.012 |
| c1  | 1.200       | 1.400  | 0.047  | 0.055 | L   | 12.900      | 13.400 | 0.508  | 0.528 |
| D   | 9.910       | 10.250 | 0.390  | 0.404 | L1  | 2.850       | 3.250  | 0.112  | 0.128 |
| E   | 8.950       | 9.750  | 0.352  | 0.384 | V   | 7/500       | REF    | 0.295  | REF   |
| E1  | 12.650      | 12.950 | 0.498  | 0.510 | Φ   | 3.400       | 3.800  | 0.134  | 0.150 |

Notes: 1.Controlling dimension: millimeters.  
 2.Maximum lead thickness includes lead finish thickness, and minimum lead thickness is the minimum thickness of base material.  
 3.If there is any question with packing specification or packing method, please contact your local CYStek sales office.

**Material:**

- Lead: Pure tin plated.
- Mold Compound: Epoxy resin family, flammability solid burning class: UL94V-0.

**Important Notice:**

- All rights are reserved. Reproduction in whole or in part is prohibited without the prior written approval of CYStek.
- CYStek reserves the right to make changes to its products without notice.
- CYStek **semiconductor products are not warranted to be suitable for use in Life-Support Applications, or systems.**
- CYStek assumes no liability for any consequence of customer product design, infringement of patents, or application assistance.