

P-Channel Enhancement Mode Power MOSFET

MTD190P10L3

BV_{DSS}	-100V
$I_D @ T_A=25^{\circ}C, V_{GS}=-10V$	-2.2A
$R_{DSON}@V_{GS}=-10V, I_D=-2A$	190mΩ (typ)
$R_{DSON}@V_{GS}=-4.5V, I_D=-1A$	217mΩ (typ)

Features

- Low Gate Charge
- Simple Drive Requirement
- Pb-free lead plating & Halogen-free package

Equivalent Circuit

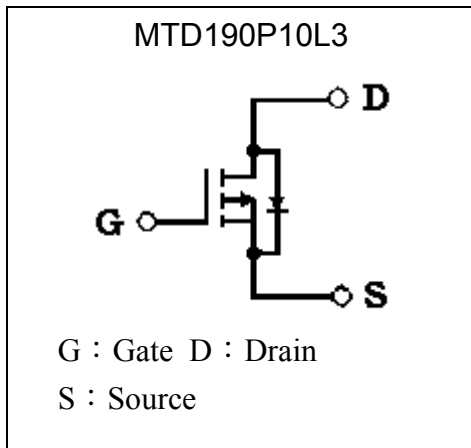

Outline

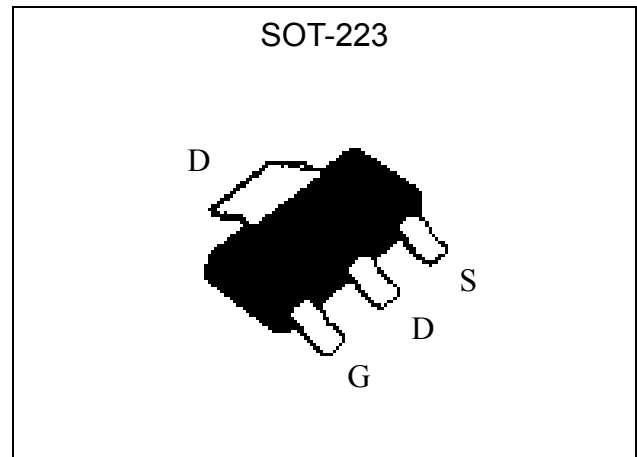

Ordering Information

Device	Package	Shipping
MTD190P10L3-0-T3-G	SOT-223 (Pb-free lead plating & Halogen-free package)	2500 pcs / Tape & Reel

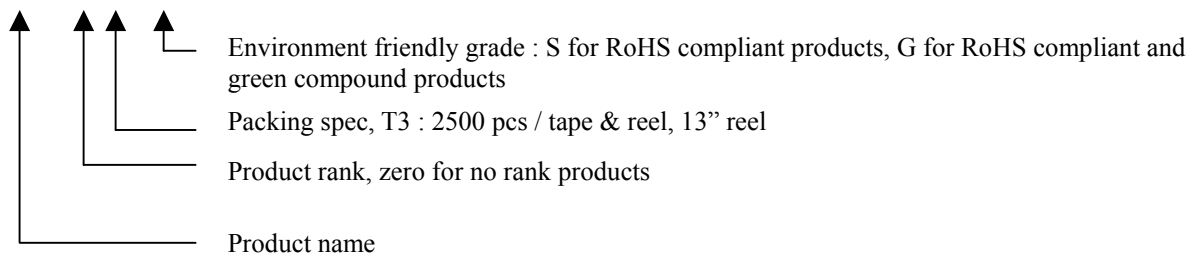



Absolute Maximum Ratings (T_C=25°C, unless otherwise noted)

Parameter	Symbol	Limits	Unit
Drain-Source Voltage	V _{DS}	-100	V
Gate-Source Voltage	V _{GS}	±20	
Continuous Drain Current @ V _{GS} =-10V, T _A =25°C	I _D	-2.2	A
Continuous Drain Current @ V _{GS} =-10V, T _A =70°C		-1.8	
Pulsed Drain Current *1	I _{DM}	-10	
Single Pulse Avalanche Current	I _{AS}	-2	
Avalanche Energy @ L=6mH, I _D =-2A, R _G =25Ω	E _{AS}	12	mJ
Repetitive Avalanche Energy @ L=0.05mH *2	E _{AR}	0.5	
Total Power Dissipation @T _A =25°C	P _D	2.5	W
Total Power Dissipation @T _A =70°C		1.6	
Operating Junction and Storage Temperature Range	T _J , T _{stg}	-55~+150	°C

Note : *1. Pulse width limited by maximum junction temperature
 *2. Duty cycle ≤ 1%

Thermal Data

Parameter	Symbol	Value	Unit
Thermal Resistance, Junction-to-case, max	R _{θJC}	15	°C/W
Thermal Resistance, Junction-to-ambient, max	R _{θJA}	50 (Note)	

Note : Surface mounted on a 1 in² pad of 2 oz. copper, t≤10s; 120° C/W when mounted on minimum copper pad.

Characteristics (T_C=25°C, unless otherwise specified)

Symbol	Min.	Typ.	Max.	Unit	Test Conditions
Static					
BV _{DSS}	-100	-	-	V	V _{GS} =0V, I _D =-250μA
V _{GS(th)}	-1	-	-2.5		V _{DS} =V _{GS} , I _D =-250μA
I _{GSS}	-	-	±100	nA	V _{GS} =±20V, V _{DS} =0V
I _{DSS}	-	-	-1	μA	V _{DS} =-80V, V _{GS} =0V
	-	-	-25		V _{DS} =-70V, V _{GS} =0V, T _J =125°C
R _{DS(ON)} *1	-	190	240	mΩ	V _{GS} =-10V, I _D =-2A
	-	217	285		V _{GS} =-4.5V, I _D =-1A
G _{FS} *1	-	5	-	S	V _{DS} =-15V, I _D =-2A
Dynamic					
Q _g *1, 2	-	16.5	-	nC	I _D =-2A, V _{DS} =-80V, V _{GS} =-10V
Q _{gs} *1, 2	-	2.6	-		
Q _{gd} *1, 2	-	4.3	-		
t _{d(ON)} *1, 2	-	9	-	ns	V _{DS} =-50V, I _D =-1A, V _{GS} =-10V, R _G =6Ω
t _r *1, 2	-	16.8	-		
t _{d(OFF)} *1, 2	-	40.4	-		
t _f *1, 2	-	27.2	-		
C _{iss}	-	729	-	pF	V _{GS} =0V, V _{DS} =-25V, f=1MHz
C _{oss}	-	45	-		
C _{rss}	-	35	-		

Source-Drain Diode					
I_S *1	-	-	-2.2	A	
I_{SM} *3	-	-	-10		
V_{SD} *1	-	-0.82	-1.2	V	$I_S=-2A, V_{GS}=0V$
trr	-	21	-	ns	$I_F=-2A, dI_F/dt=100A/\mu s$
Qrr	-	20	-	nC	

Note : *1.Pulse Test : Pulse Width $\leq 300\mu s$, Duty Cycle $\leq 2\%$
 *2.Independent of operating temperature
 *3.Pulse width limited by maximum junction temperature.

Recommended soldering footprint

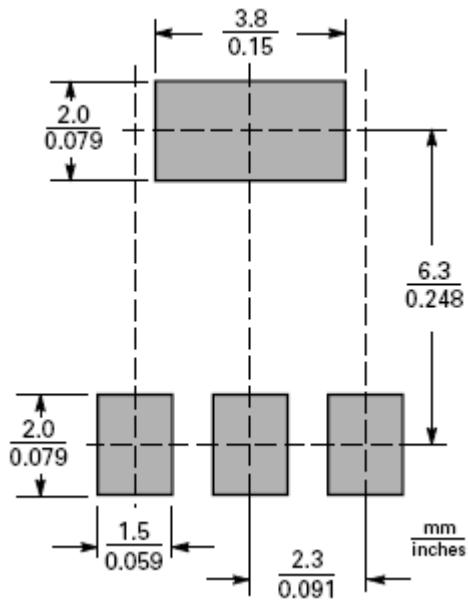

Typical Characteristics

Typical Output Characteristics

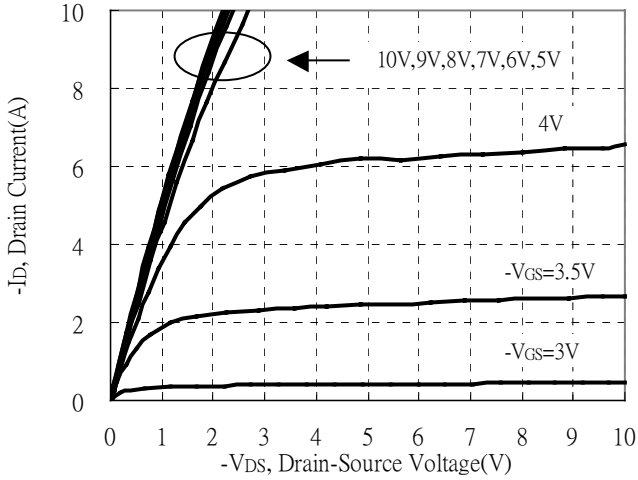

Brekdown Voltage vs Ambient Temperature

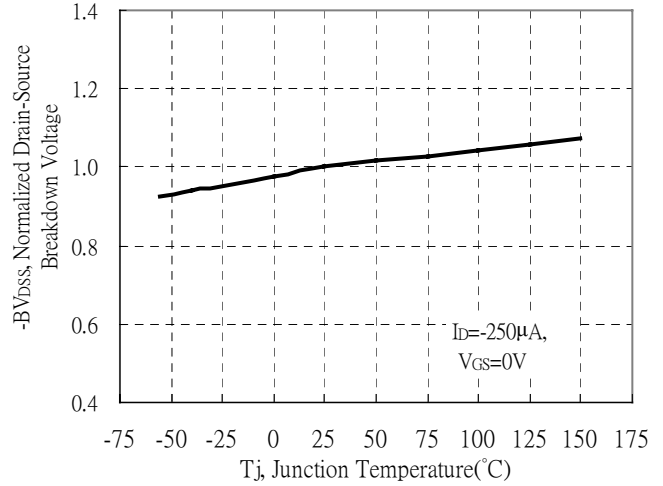

Static Drain-Source On-State resistance vs Drain Current

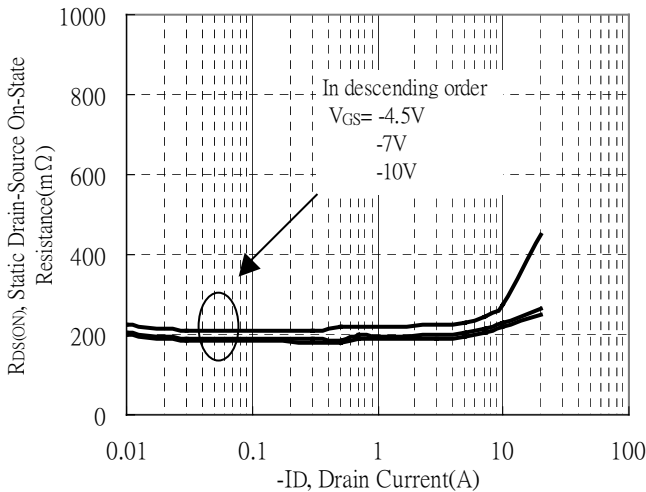

Reverse Drain Current vs Source-Drain Voltage

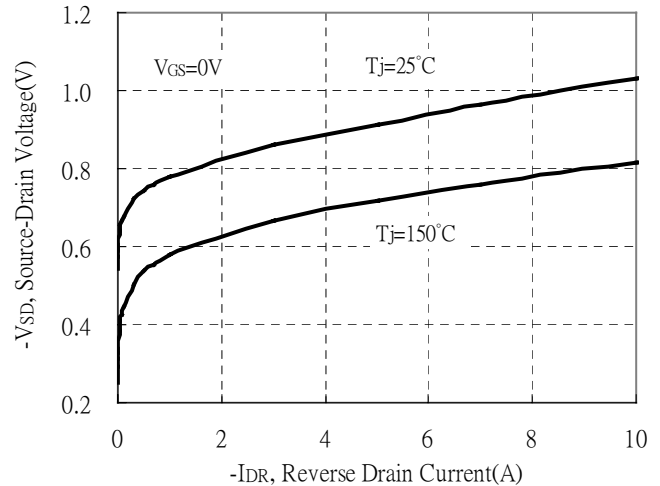

Static Drain-Source On-State Resistance vs Gate-Source Voltage

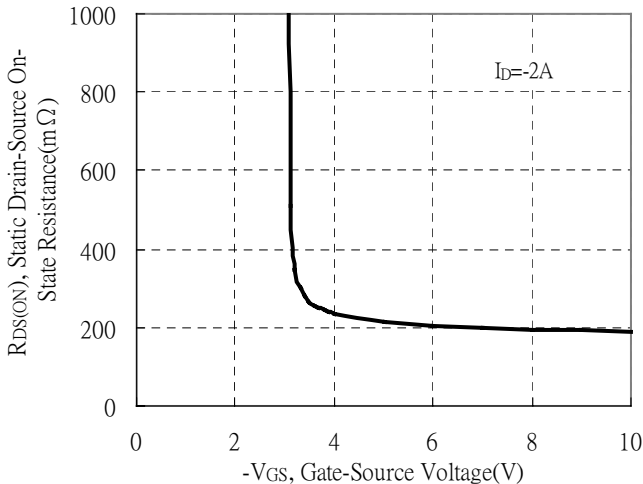

Drain-Source On-State Resistance vs Junction Temperature

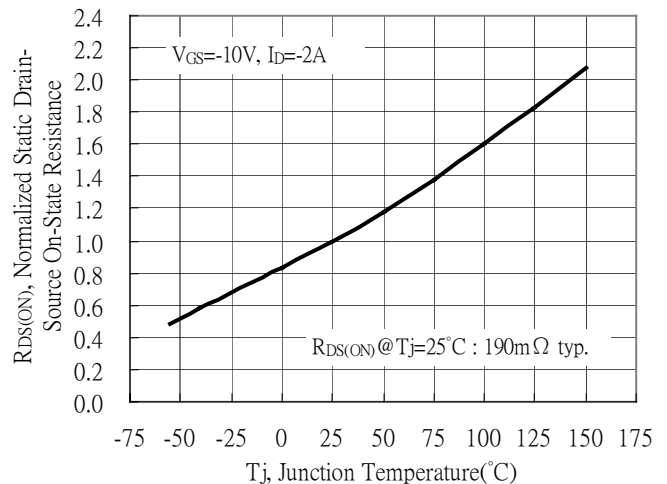

Typical Characteristics(Cont.)

Capacitance vs Drain-to-Source Voltage

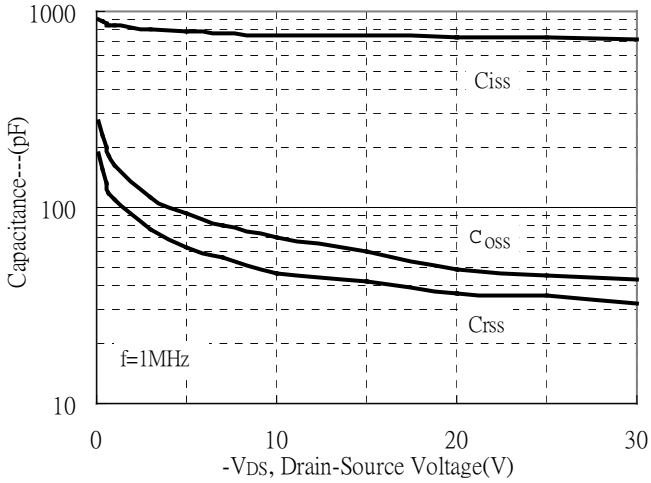

Threshold Voltage vs Junction Temperature

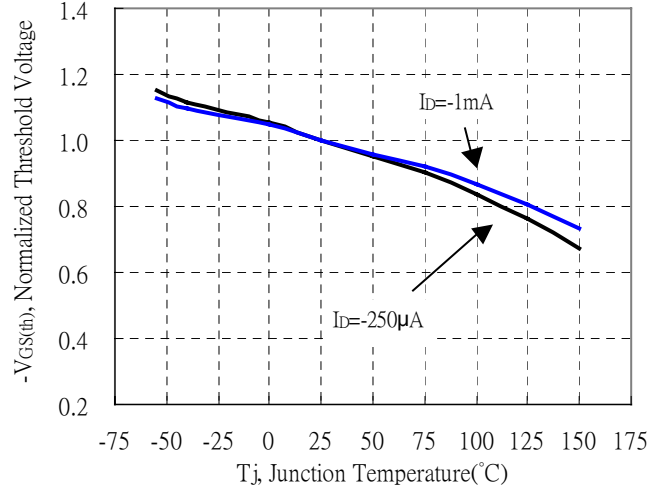

Maximum Safe Operating Area

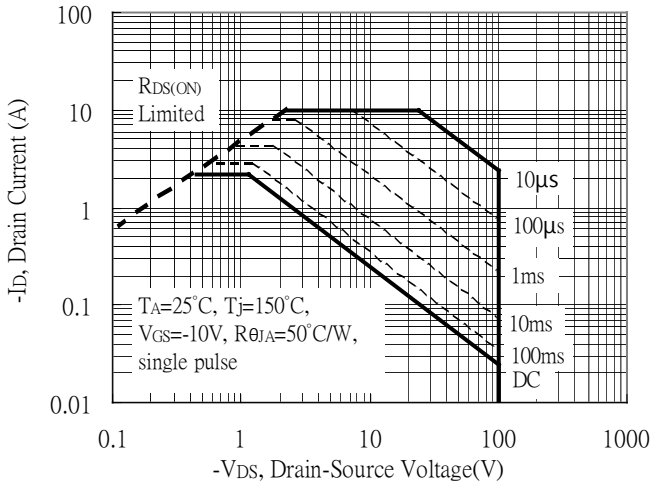

Gate Charge Characteristics

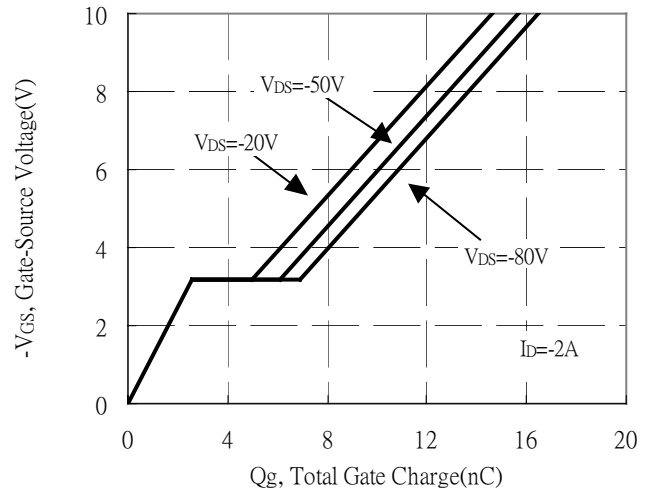

Maximum Drain Current vs Junction Temperature

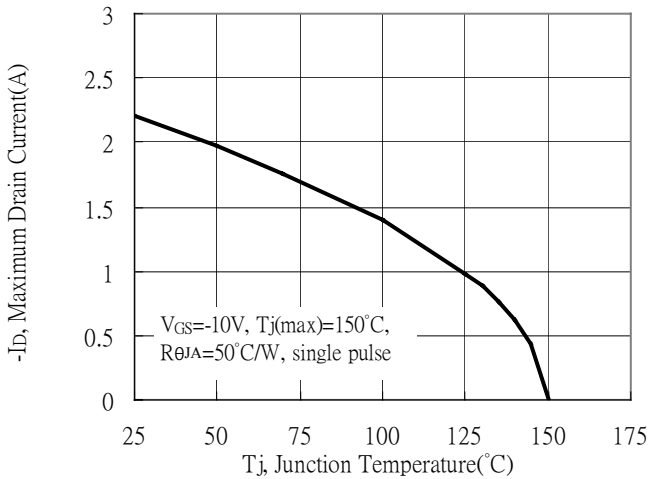

Typical Transfer Characteristics

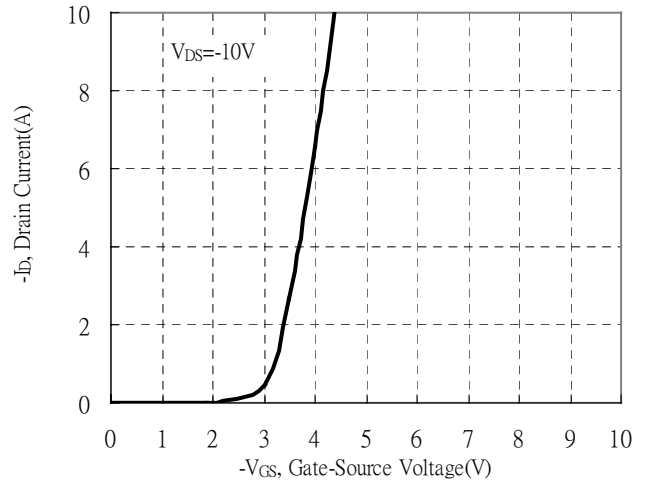



Typical Characteristics(Cont.)

Forward Transfer Admittance vs Drain Current

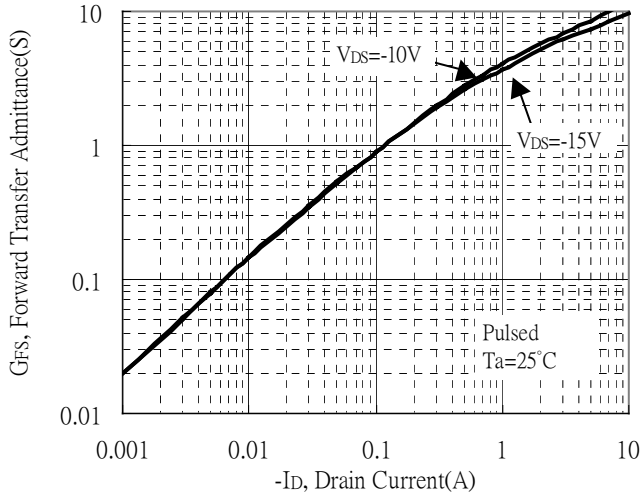

Single Pulse Power Rating, Junction to Case

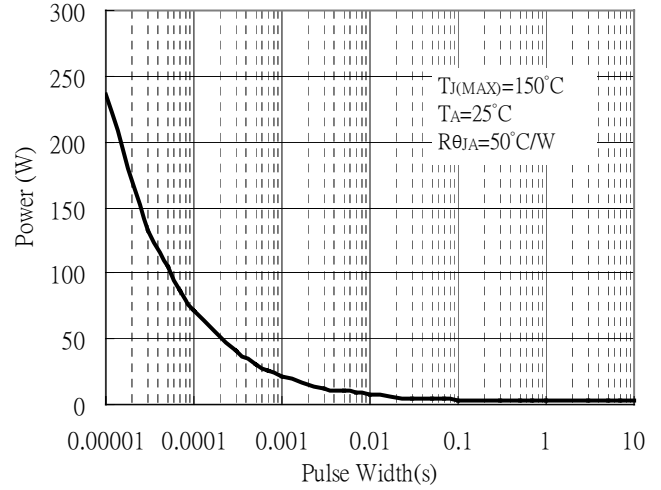

Transient Thermal Response Curves

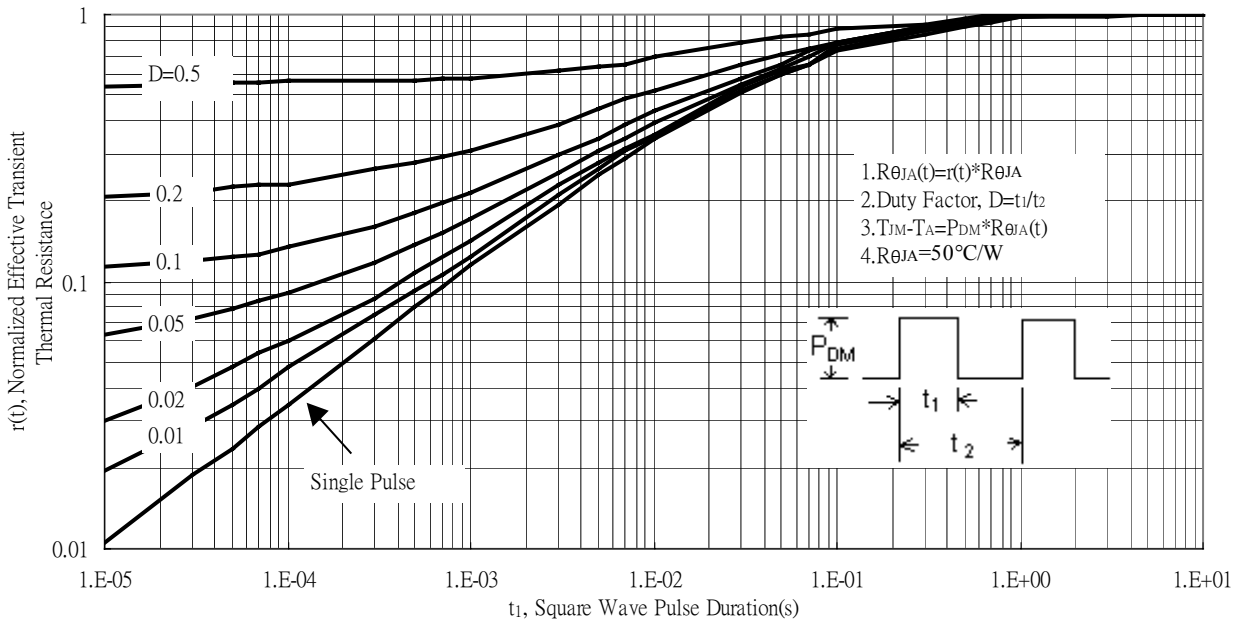

Reel Dimension

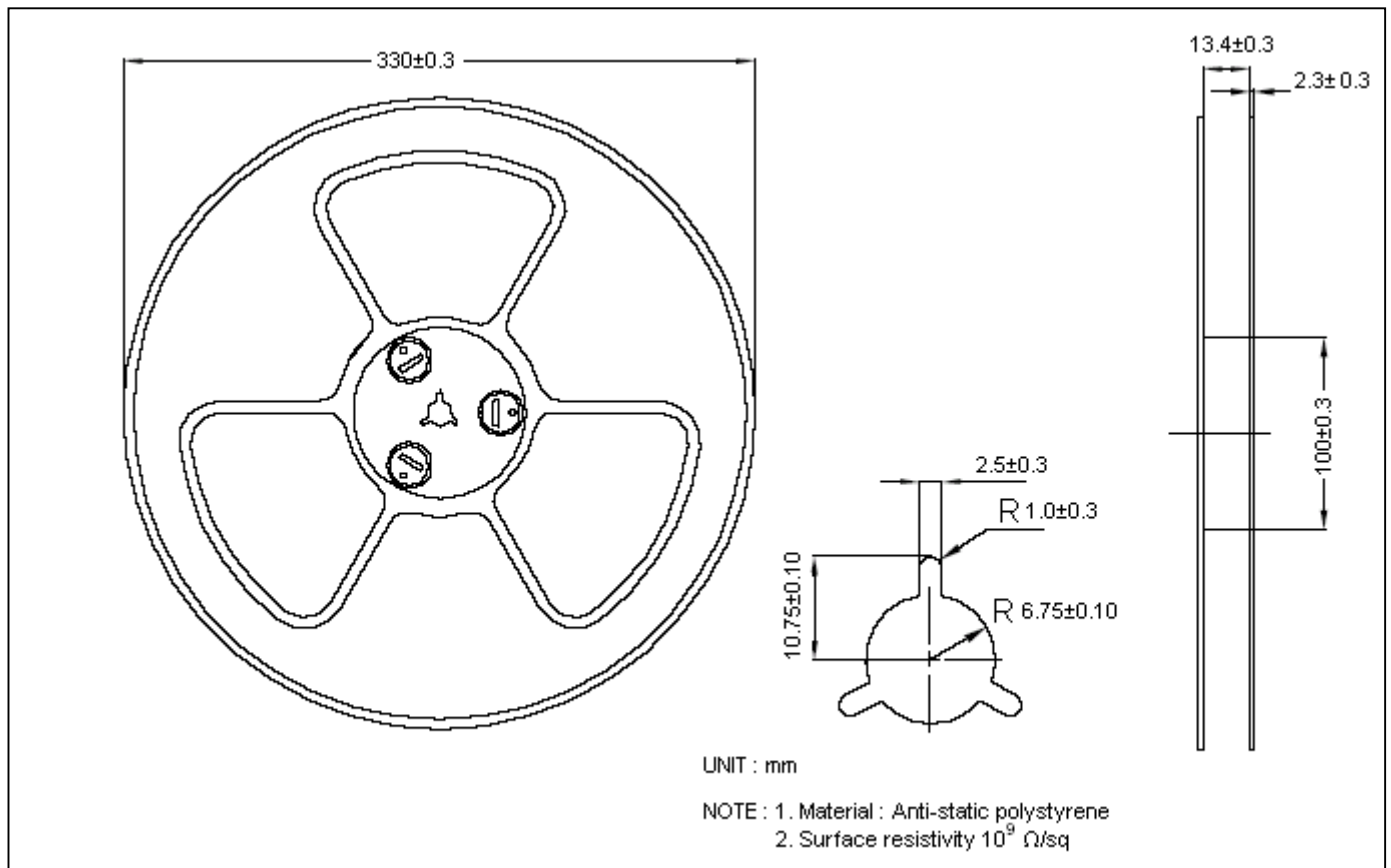

Carrier Tape Dimension

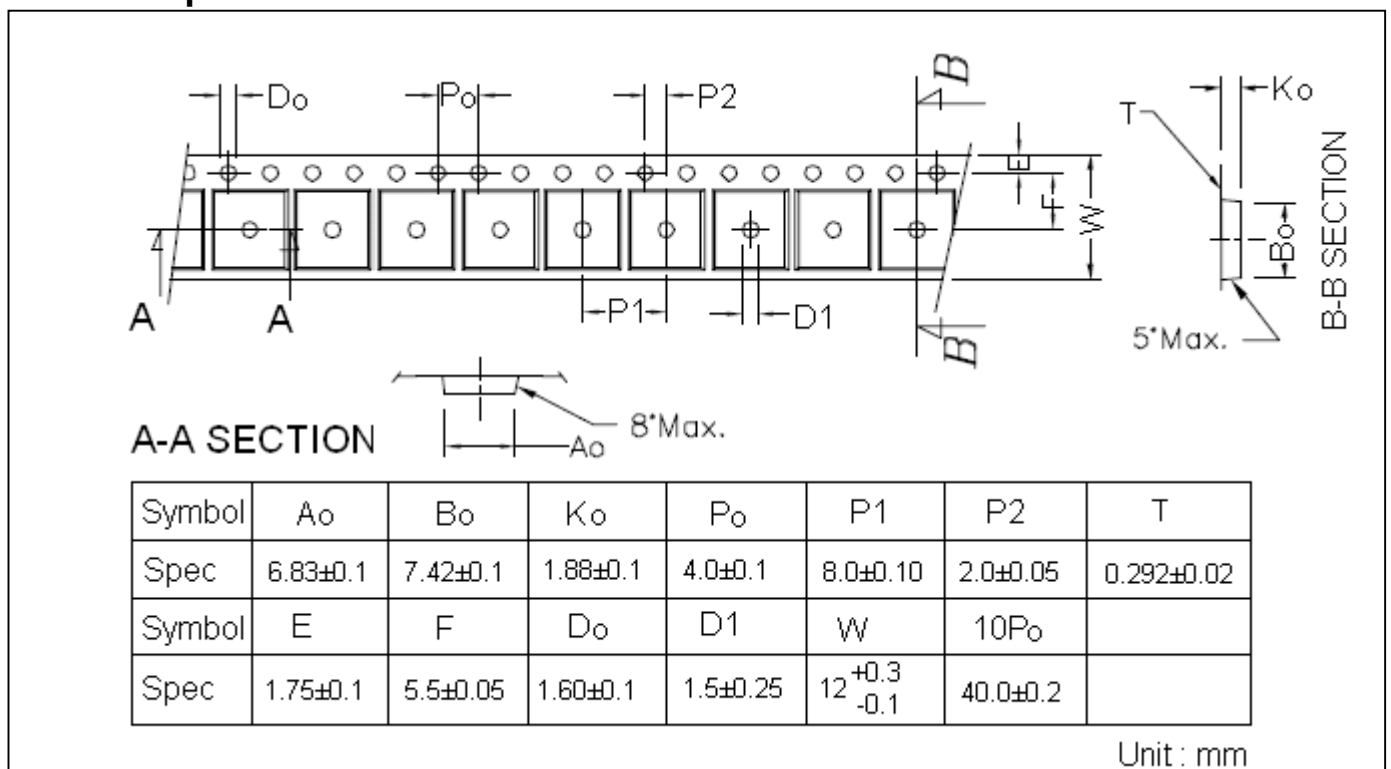

Recommended wave soldering condition

Product	Peak Temperature	Soldering Time
Pb-free devices	260 +0/-5 °C	5 +1/-1 seconds

Recommended temperature profile for IR reflow



Profile feature	Sn-Pb eutectic Assembly	Pb-free Assembly
Average ramp-up rate (Tsmax to Tp)	3°C/second max.	3°C/second max.
Preheat		
-Temperature Min(Ts min)	100°C	150°C
-Temperature Max(Ts max)	150°C	200°C
-Time(ts min to ts max)	60-120 seconds	60-180 seconds
Time maintained above:		
-Temperature (TL)	183°C	217°C
- Time (tL)	60-150 seconds	60-150 seconds
Peak Temperature(TP)	240 +0/-5 °C	260 +0/-5 °C
Time within 5°C of actual peak temperature(tp)	10-30 seconds	20-40 seconds
Ramp down rate	6°C/second max.	6°C/second max.
Time 25 °C to peak temperature	6 minutes max.	8 minutes max.

Note : All temperatures refer to topside of the package, measured on the package body surface.

SOT-223 Dimension

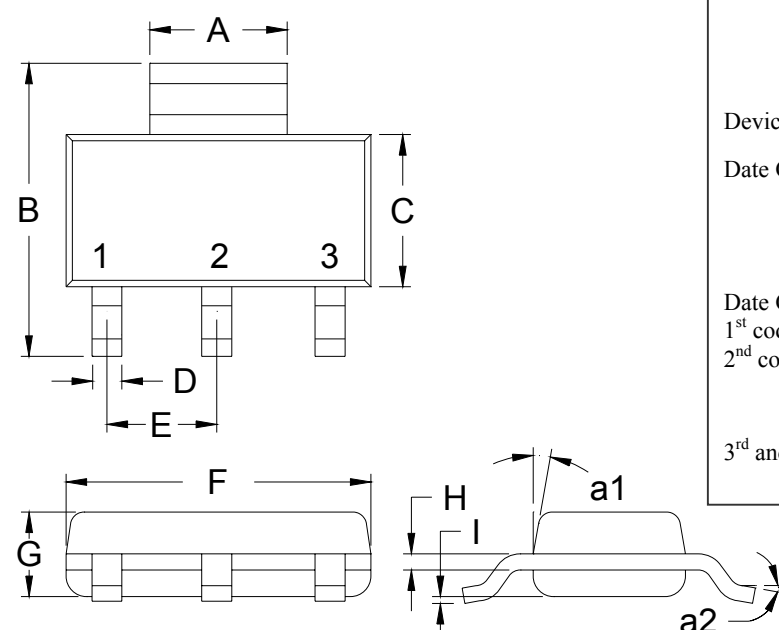

Marking:

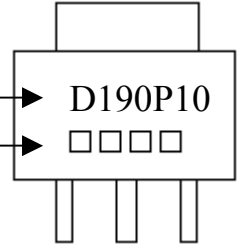

Device Name → **D190P10**

Date Code → □ □ □ □

Date Code(counting from left to right) :

1st code: year code, the last digit of Christian year

2nd code : month code, Jan→A, Feb→B, Mar→C, Apr→D, May→E, Jun→F, Jul→G, Aug→H, Sep→J, Oct→K, Nov→L, Dec→M

3rd and 4th codes : production serial number, 01~99

Style: Pin 1.Gate 2.Drain 3.Source

3-Lead SOT-223 Plastic Surface Mounted Package
CYStek Package Code: L3

*: Typical

DIM	Inches		Millimeters		DIM	Inches		Millimeters	
	Min.	Max.	Min.	Max.		Min.	Max.	Min.	Max.
A	0.1142	0.1220	2.90	3.10	G	0.0551	0.0709	1.40	1.80
B	0.2638	0.2874	6.70	7.30	H	0.0098	0.0138	0.25	0.35
C	0.1299	0.1457	3.30	3.70	I	0.0008	0.0039	0.02	0.10
D	0.0236	0.0315	0.60	0.80	a1	*13°	-	*13°	-
E	*0.0906	-	*2.30	-	a2	0°	10°	0°	10°
F	0.2480	0.2638	6.30	6.70					

Notes: 1.Controlling dimension: millimeters.
 2.Maximum lead thickness includes lead finish thickness, and minimum lead thickness is the minimum thickness of base material.
 3.If there is any question with packing specification or packing method, please contact your local CYStek sales office.

Material:

- Lead: Pure tin plated.
- Mold Compound: Epoxy resin family, flammability solid burning class: UL94V-0.

Important Notice:

- All rights are reserved. Reproduction in whole or in part is prohibited without the prior written approval of CYStek.
- CYStek reserves the right to make changes to its products without notice.
- CYStek **semiconductor products are not warranted to be suitable for use in Life-Support Applications, or systems.**
- CYStek assumes no liability for any consequence of customer product design, infringement of patents, or application assistance.