

**P-Channel Enhancement Mode Power MOSFET**

# MTD140P15J3

<b>BV<sub>DSS</sub></b>	<b>-150V</b>
<b>I<sub>D</sub> @ V<sub>GS</sub>=-10V, T<sub>C</sub>=25°C</b>	<b>-15A</b>
<b>R<sub>DS(ON)</sub>@ V<sub>GS</sub>=-10V, I<sub>D</sub>=-12A</b>	<b>141mΩ (typ)</b>
<b>R<sub>DS(ON)</sub>@ V<sub>GS</sub>=-4.5V, I<sub>D</sub>=-10A</b>	<b>175mΩ (typ)</b>

**Features**

- Single Drive Requirement
- Low On-resistance
- Fast switching Characteristic
- Pb-free lead plating and halogen-free package

**Symbol**

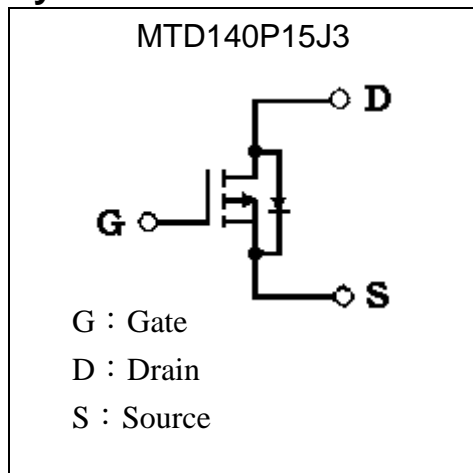

**Outline**

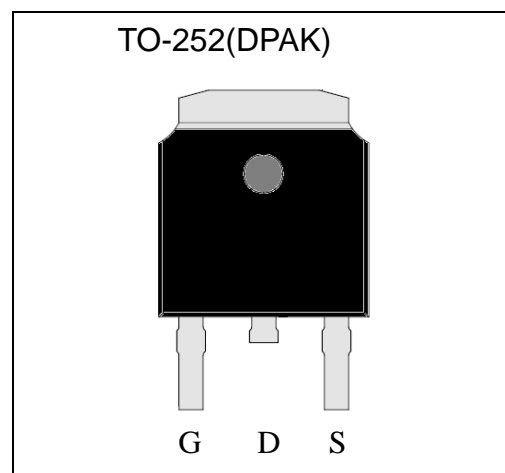

**Ordering Information**

Device	Package	Shipping
MTD140P15J3-0-T3-G	TO-252 (Pb-free lead plating and halogen-free package)	2500 pcs / Tape & Reel

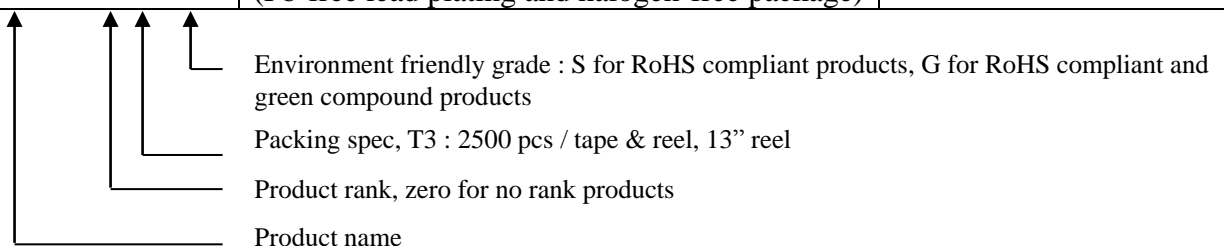

**Absolute Maximum Ratings** (Ta=25°C)

Parameter		Symbol	Limits	Unit
Drain-Source Voltage		V <sub>DS</sub>	-150	V
Gate-Source Voltage		V <sub>GS</sub>	±20	
Continuous Drain Current @ V <sub>GS</sub> =-10V, T <sub>C</sub> =25°C (Note1)		I <sub>D</sub>	-15	A
Continuous Drain Current @ V <sub>GS</sub> =-10V, T <sub>C</sub> =100°C (Note1)			-10.6	
Continuous Drain Current @ V <sub>GS</sub> =-10V, T <sub>A</sub> =25°C (Note4)			-2.4	
Continuous Drain Current @ V <sub>GS</sub> =-10V, T <sub>A</sub> =70°C (Note4)			-1.9	
Pulsed Drain Current (Note3)		I <sub>DM</sub>	-60	
Power Dissipation	T <sub>C</sub> =25°C (Note1)	P <sub>D</sub>	100	W
	T <sub>C</sub> =100°C (Note1)		50	
	T <sub>A</sub> =25°C (Note2)	P <sub>DSM</sub>	2	
	T <sub>A</sub> =70°C (Note2)		1.3	
Single Pulse Avalanche Energy		E <sub>AS</sub>	225	mJ
Single Pulse Avalanche Current		I <sub>AS</sub>	-15	A
Operating Junction and Storage Temperature		T <sub>j</sub> , T <sub>stg</sub>	-55~+175	°C

**Thermal Data**

Parameter	Symbol	Value	Unit
Thermal Resistance, Junction-to-case, max	R <sub>th,j-c</sub>	1.5	°C/W
Thermal Resistance, Junction-to-ambient, max (Note2)	R <sub>th,j-a</sub>	62.5	
Thermal Resistance, Junction-to-ambient, max (Note4)		90	

- Note : 1.The power dissipation P<sub>D</sub> is based on T<sub>J(MAX)</sub>=175 °C, using junction-to-case thermal resistance, and is more useful in setting the upper dissipation limit for cases where additional heatsinking is used.
2. The value of R<sub>θJA</sub> is measured with the device mounted on 1 in<sup>2</sup> FR-4 board with 2 oz. copper, in a still air environment with T<sub>A</sub>=25 °C. The power dissipation P<sub>DSM</sub> is based on R<sub>θJA</sub> and the maximum allowed junction temperature of 150°C. The value in any given application depends on the user's specific board design.
3. Repetitive rating, pulse width limited by junction temperature T<sub>J(MAX)</sub>=175 °C. Ratings are based on low frequency and low duty cycles to keep initial T<sub>J</sub>=25°C.
4. When mounted on the minimum pad size recommended (PCB mount), t≤10s.

**Characteristics (T<sub>j</sub>=25°C, unless otherwise specified)**

Symbol	Min.	Typ.	Max.	Unit	Test Conditions
<b>Static</b>					
BV <sub>DSS</sub>	-150	-	-	V	V <sub>GS</sub> =0V, I <sub>D</sub> =-250μA
ΔBV <sub>DSS</sub> /ΔT <sub>j</sub>	-	-0.12	-	V/°C	Reference to 25°C, I <sub>D</sub> =-250μA
V <sub>GS(th)</sub>	-1.5	-	-2.5	V	V <sub>DS</sub> = V <sub>GS</sub> , I <sub>D</sub> =-250μA
G <sub>FS</sub>	-	18	-	S	V <sub>DS</sub> = -5V, I <sub>D</sub> =-12A
I <sub>GSS</sub>	-	-	±100	nA	V <sub>GS</sub> =±20V, V <sub>DS</sub> =0V
I <sub>DSS</sub>	-	-	-1	μA	V <sub>DS</sub> = -120V, V <sub>GS</sub> = 0V
I <sub>DSS</sub>	-	-	-25		V <sub>DS</sub> = -120V, V <sub>GS</sub> = 0V, T <sub>j</sub> =70°C
*R <sub>DS(ON)</sub>	-	141	185	mΩ	V <sub>GS</sub> = -10V, I <sub>D</sub> =-12A
*R <sub>DS(ON)</sub>	-	175	230		V <sub>GS</sub> = -4.5V, I <sub>D</sub> =-10A
<b>Dynamic</b>					
*Q <sub>g</sub>	-	51	-	nC	V <sub>DS</sub> =-120V, I <sub>D</sub> =-12A, V <sub>GS</sub> =-10V
*Q <sub>gs</sub>	-	11	-		
*Q <sub>gd</sub>	-	21	-		
*t <sub>d(ON)</sub>	-	14	-	ns	V <sub>DS</sub> =-75V, V <sub>GS</sub> =-10V, I <sub>D</sub> =-12A , R <sub>G</sub> =3.3Ω
*t <sub>r</sub>	-	16	-		
*t <sub>d(OFF)</sub>	-	37	-		
*t <sub>f</sub>	-	24	-		
C <sub>iss</sub>	-	2473	-	pF	V <sub>GS</sub> =0V, V <sub>DS</sub> =-25V, f=1MHz
C <sub>oss</sub>	-	122	-		
C <sub>rss</sub>	-	75	-		
R <sub>g</sub>	-	2.9	-		
<b>Source-Drain Diode</b>					
*V <sub>SD</sub>	-	-0.84	-1.2	V	I <sub>S</sub> =-12A, V <sub>GS</sub> =0V
*I <sub>S</sub>	-	-	-15	A	
*t <sub>rr</sub>	-	70	-	ns	I <sub>F</sub> =-12A, V <sub>GS</sub> =0V, dI <sub>F</sub> /dt=-100A/μs
*Q <sub>rr</sub>	-	245	-	nC	

\*Pulse Test : Pulse Width ≤300μs, Duty Cycle≤2%

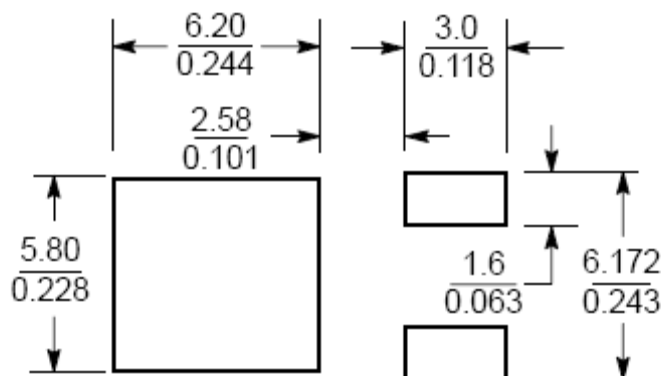
**Recommended soldering footprint**

 Unit (  $\frac{\text{mm}}{\text{inch}}$  )

**Typical Characteristics**

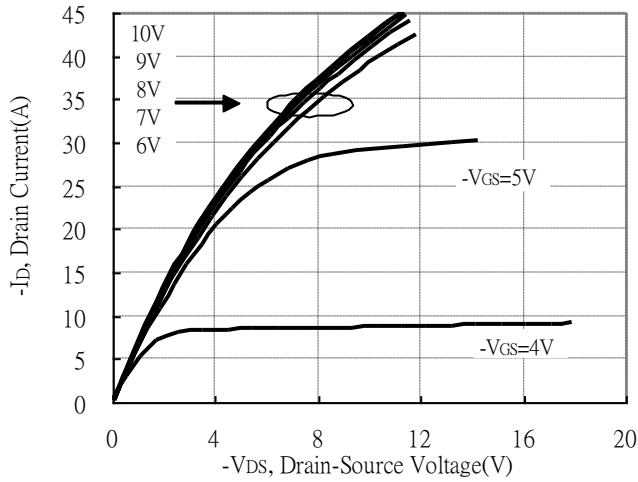
Typical Output Characteristics

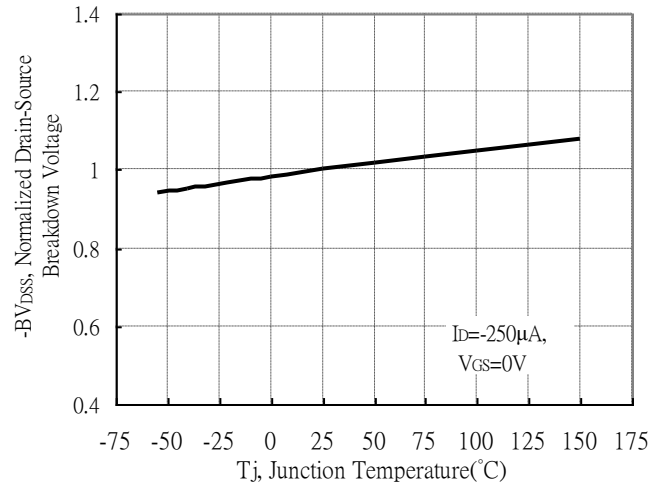

Brekdown Voltage vs Ambient Temperature



Static Drain-Source On-State resistance vs Drain Current

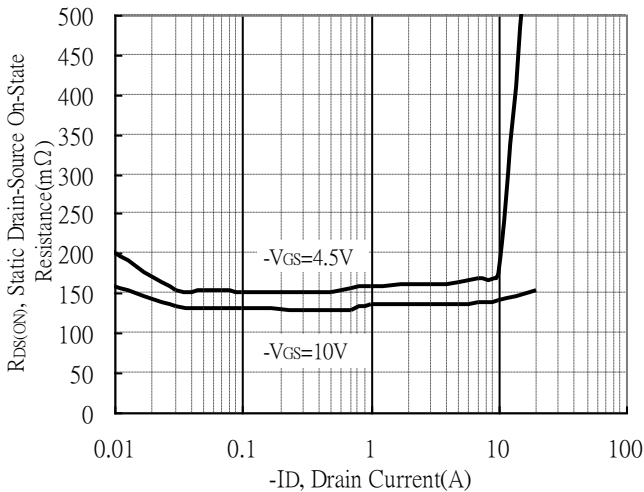

Reverse Drain Current vs Source-Drain Voltage

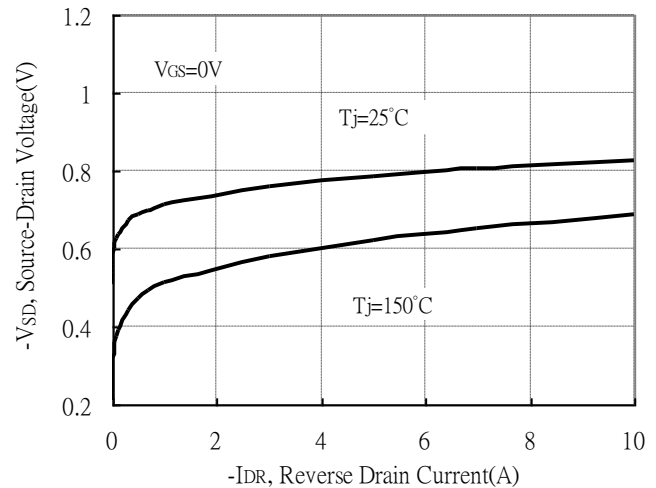

Static Drain-Source On-State Resistance vs Gate-Source Voltage

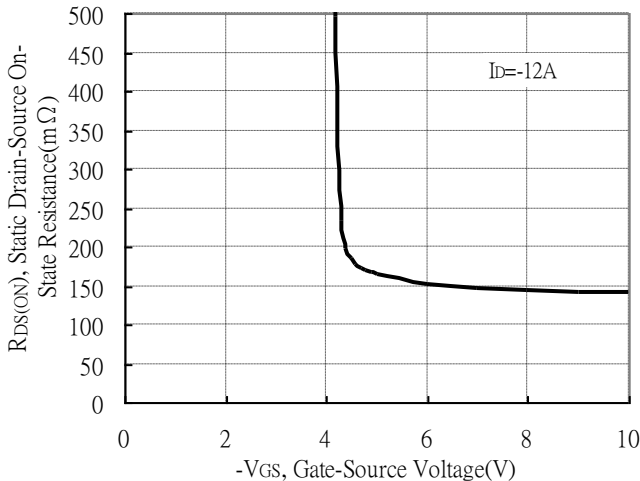

Drain-Source On-State Resistance vs Junction Temperature

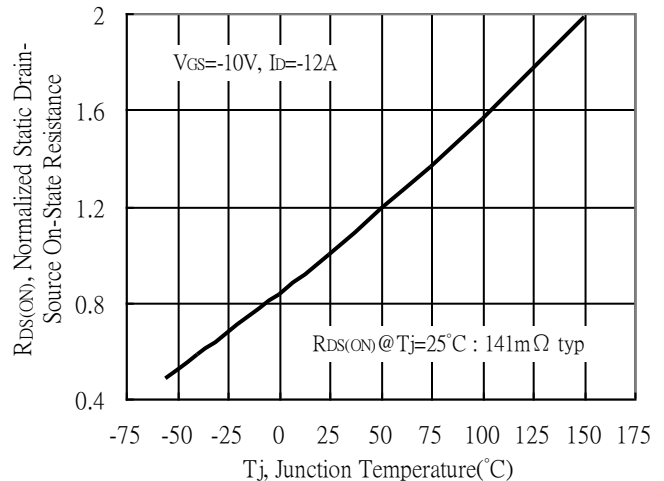

**Typical Characteristics(Cont.)**

Capacitance vs Drain-to-Source Voltage

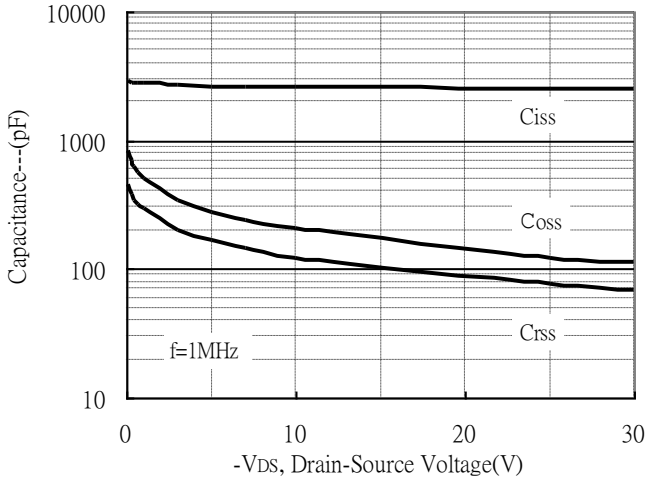

Threshold Voltage vs Junction Temperature

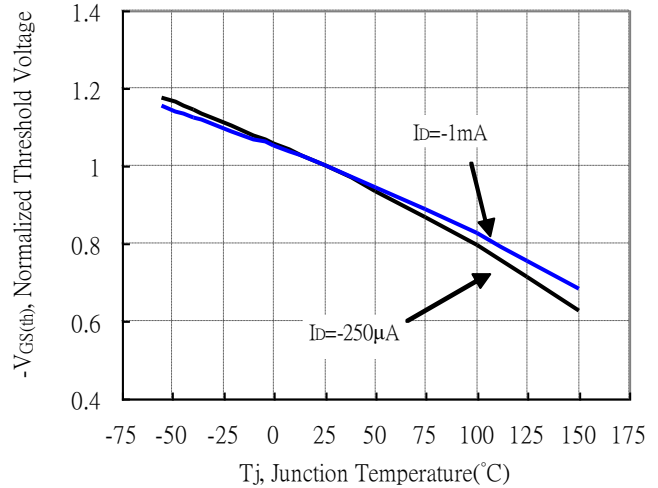

Forward Transfer Admittance vs Drain Current

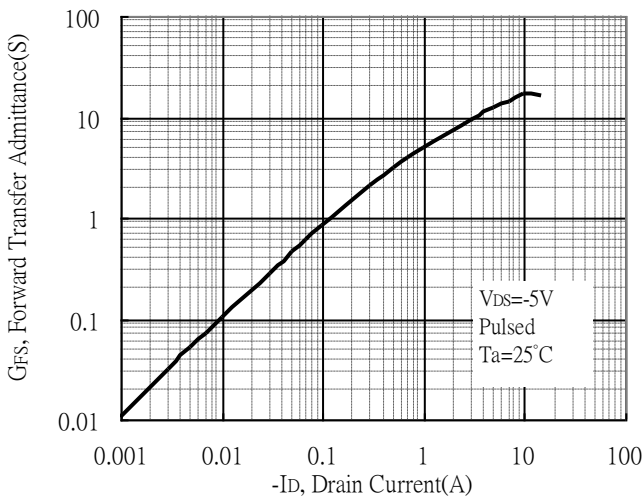

Gate Charge Characteristics

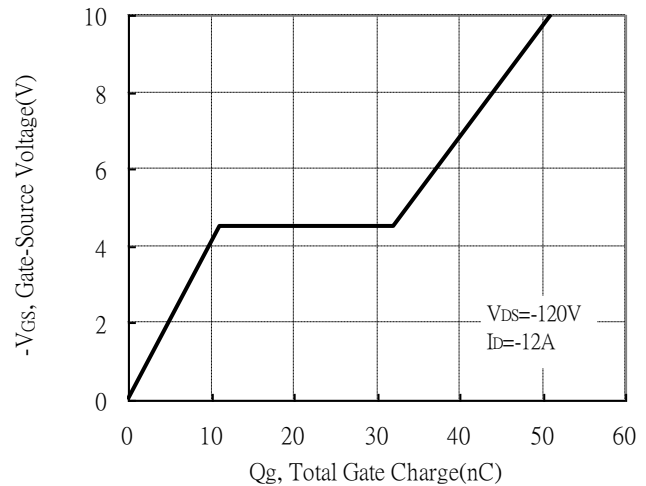

Maximum Safe Operating Area

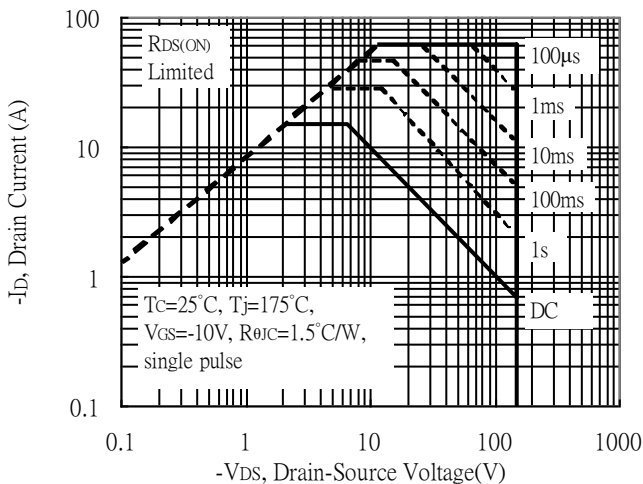

Maximum Drain Current vs Case Temperature

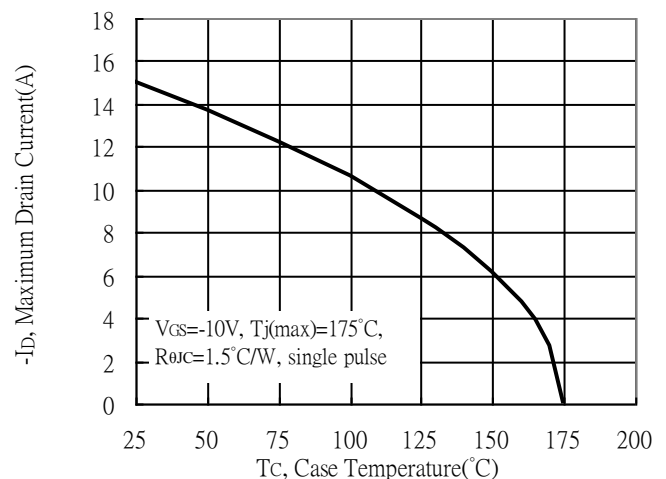

**Typical Characteristics(Cont.)**

Single Pulse Power Rating, Junction to Case

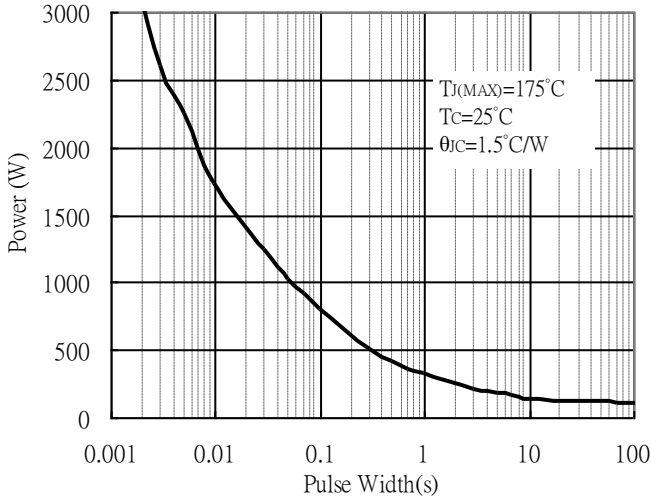

Typical Transfer Characteristics

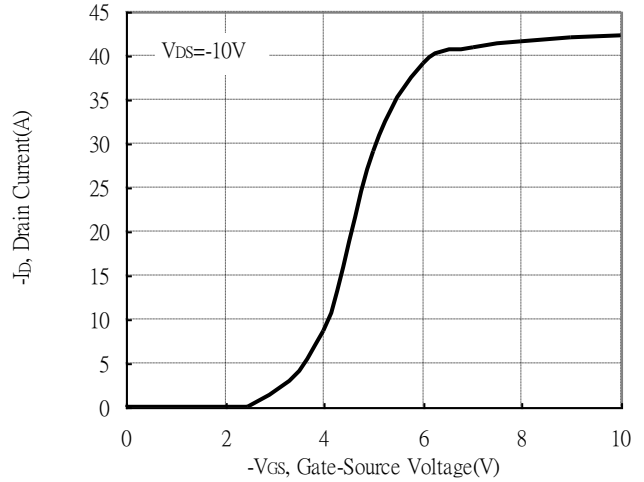

Power Derating Curve

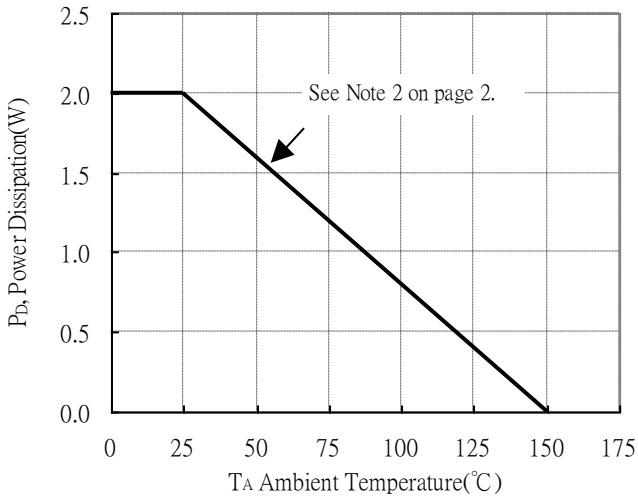

Transient Thermal Response Curves

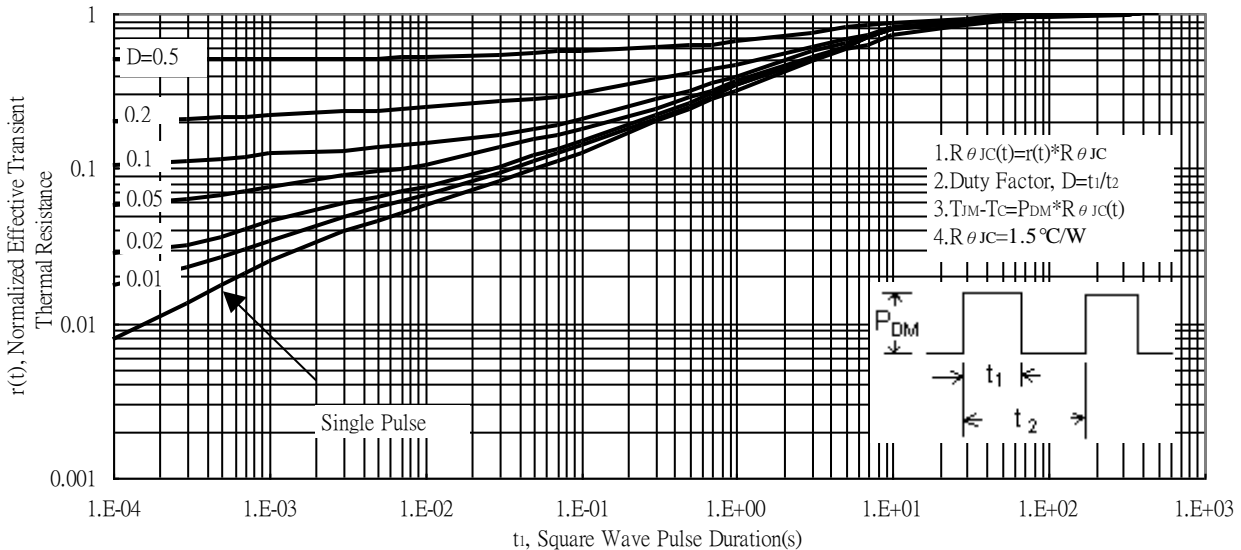

**Reel Dimension**

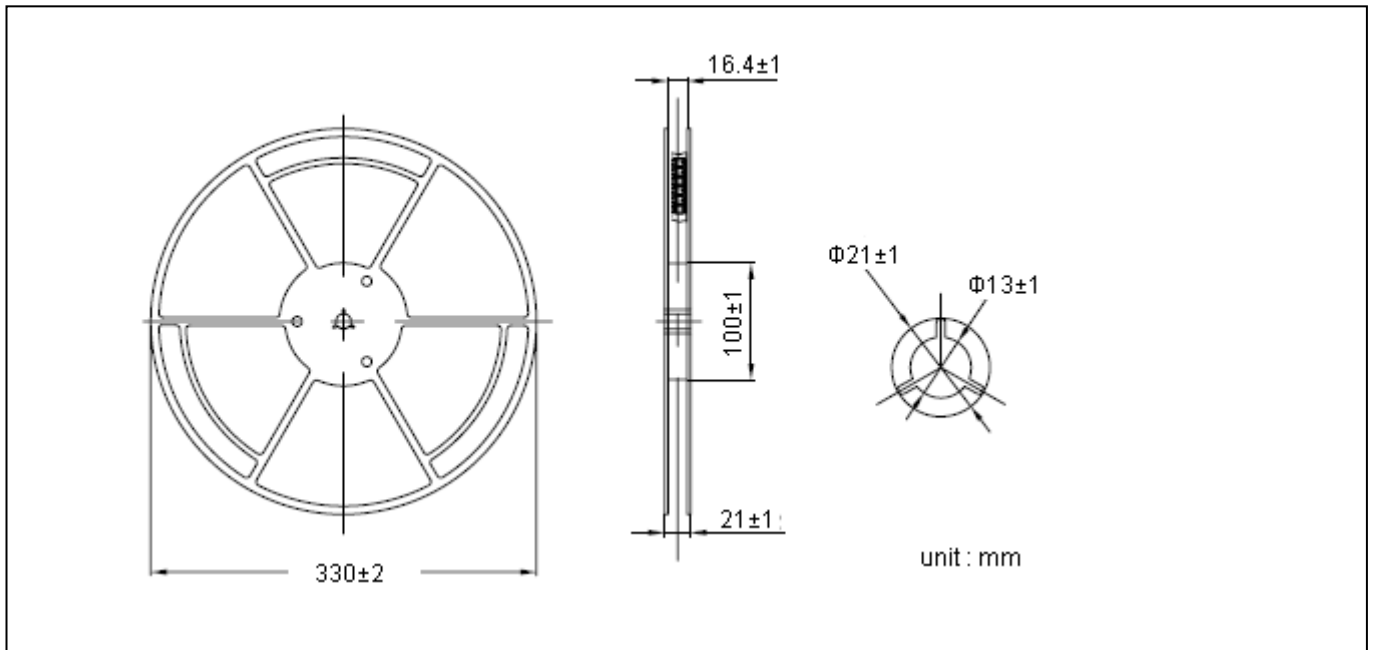

**Carrier Tape Dimension**

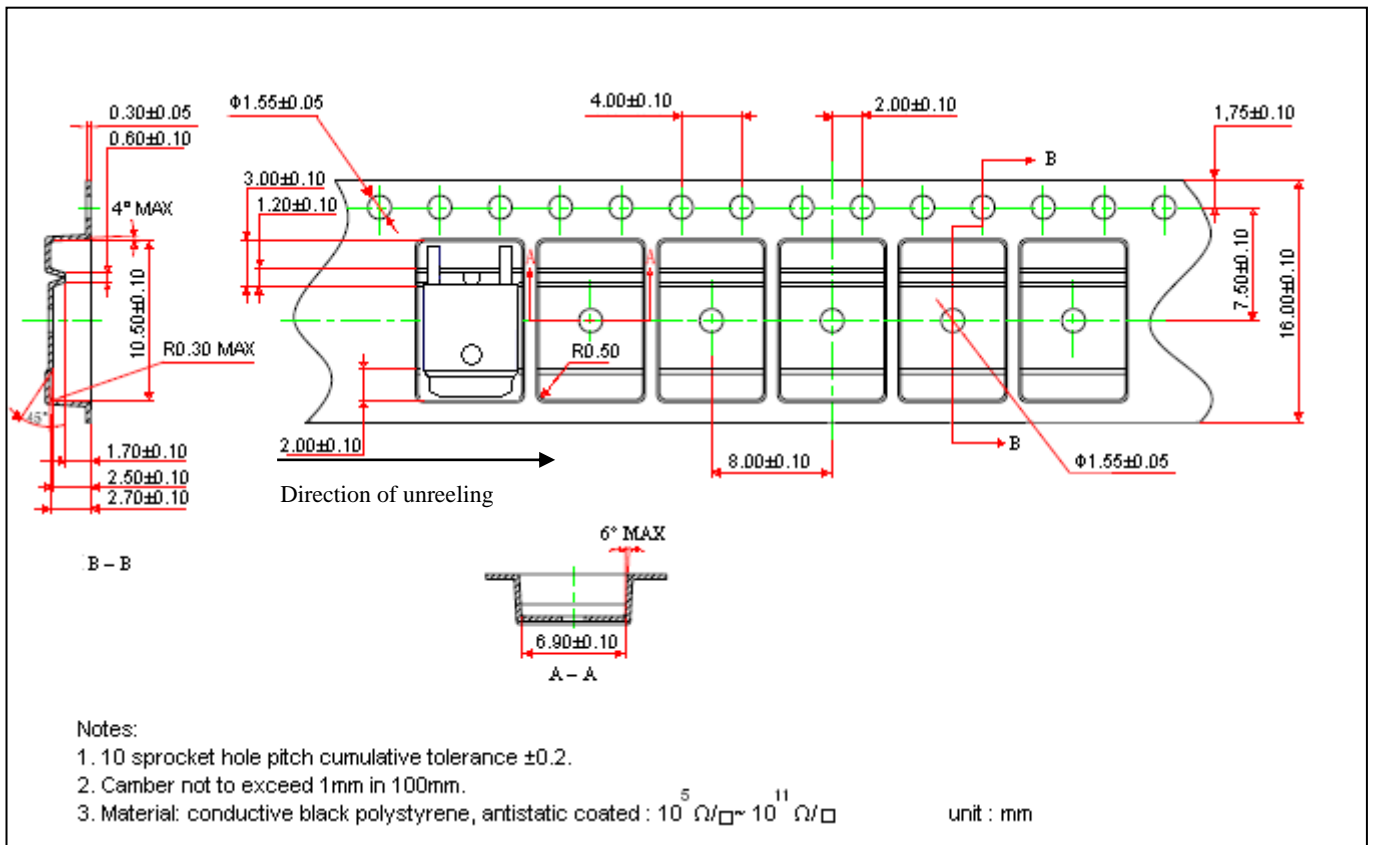

**Recommended wave soldering condition**

Product	Peak Temperature	Soldering Time
Pb-free devices	260 +0/-5 °C	5 +1/-1 seconds

**Recommended temperature profile for IR reflow**

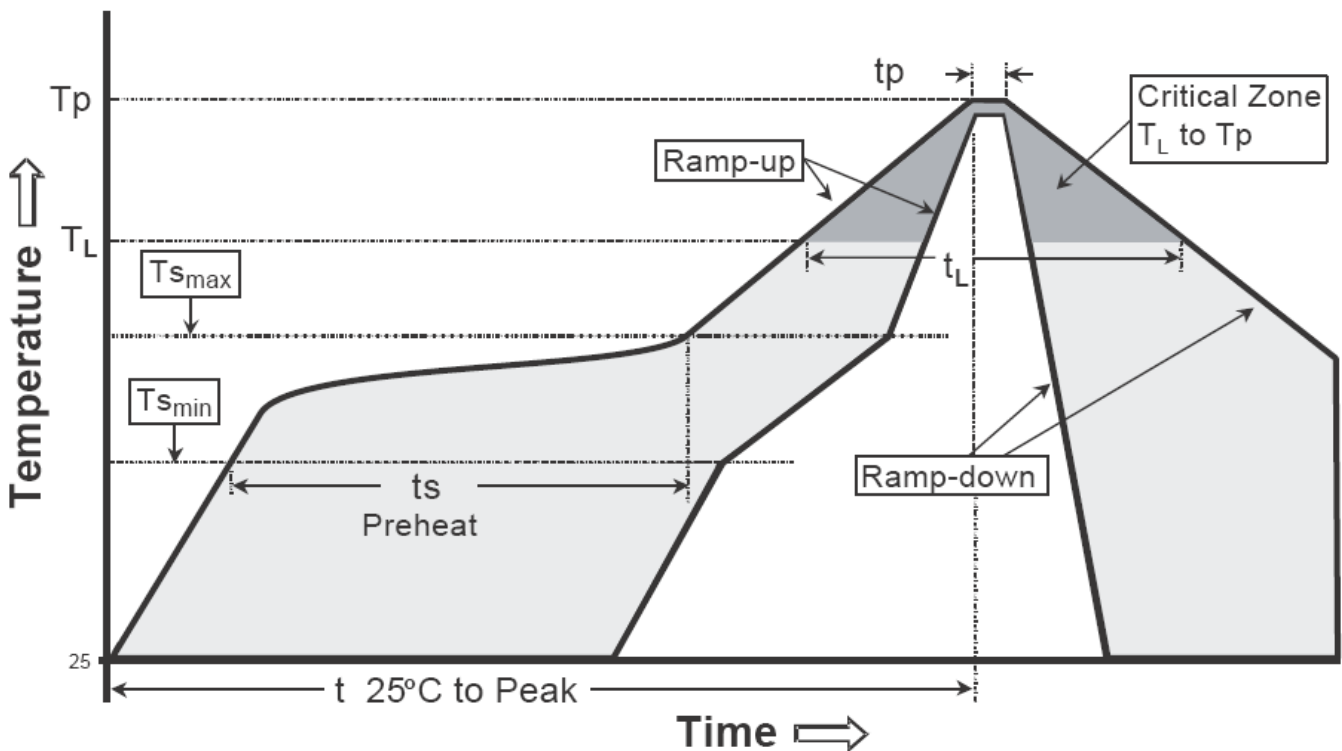

Profile feature	Sn-Pb eutectic Assembly	Pb-free Assembly
Average ramp-up rate (T <sub>smax</sub> to T <sub>p</sub> )	3°C/second max.	3°C/second max.
Preheat		
-Temperature Min(T <sub>s min</sub> )	100°C	150°C
-Temperature Max(T <sub>s max</sub> )	150°C	200°C
-Time(t <sub>s min</sub> to t <sub>s max</sub> )	60-120 seconds	60-180 seconds
Time maintained above:		
-Temperature (T <sub>L</sub> )	183°C	217°C
- Time (t <sub>L</sub> )	60-150 seconds	60-150 seconds
Peak Temperature(T <sub>P</sub> )	240 +0/-5 °C	260 +0/-5 °C
Time within 5°C of actual peak temperature(tp)	10-30 seconds	20-40 seconds
Ramp down rate	6°C/second max.	6°C/second max.
Time 25 °C to peak temperature	6 minutes max.	8 minutes max.

Note : All temperatures refer to topside of the package, measured on the package body surface.



**TO-252 Dimension**

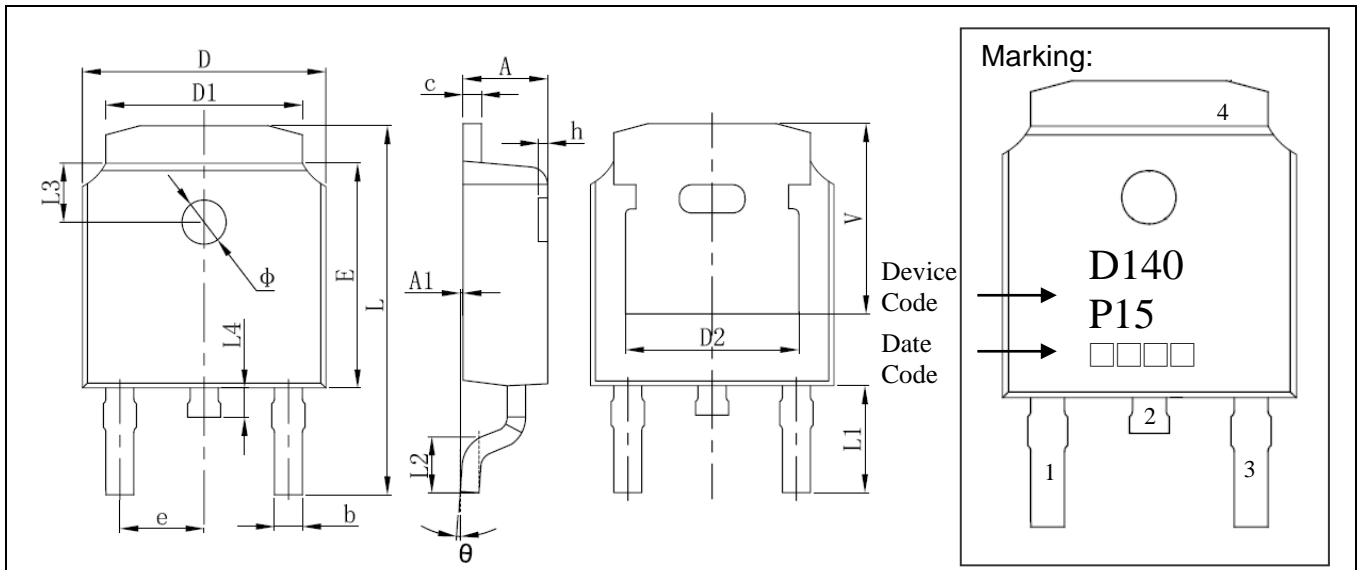

**3-Lead TO-252 Plastic Surface Mount Package**  
 CYStek Package Code: J3

Style: Pin 1.Gate 2.Drain 3.Source 4.Drain

Date Code :  
 First Code : Last digit of Christian Year  
 Second Code : Month Code : Jan→A, Feb→B, Mar→C, Apr→D, May→E, Jun→F, Jul→G,  
 Aug→H, Sep→J, Oct→K, Nov→L, Dec→M  
 Last Two Codes : Production Serial Code, 01~99

DIM	Inches		Millimeters		DIM	Inches		Millimeters	
	Min.	Max.	Min.	Max.		Min.	Max.	Min.	Max.
A	0.087	0.094	2.200	2.400	L	0.382	0.406	9.712	10.312
A1	0.000	0.005	0.000	0.127	L1	0.114	REF	2.900	REF
b	0.025	0.030	0.635	0.770	L2	0.055	0.067	1.400	1.700
c	0.018	0.023	0.460	0.580	L3	0.063	REF	1.600	REF
D	0.256	0.264	6.500	6.700	L4	0.024	0.039	0.600	1.000
D1	0.201	0.215	5.100	5.460	Φ	0.043	0.051	1.100	1.300
D2	0.190	REF	4.830	REF	θ	0°	8°	0°	8°
E	0.236	0.244	6.000	6.200	h	0.000	0.012	0.000	0.300
e	0.086	0.094	2.186	2.386	v	0.207	REF	5.250	REF

Notes: 1.Controlling dimension: millimeters.  
 2.Maximum lead thickness includes lead finish thickness, and minimum lead thickness is the minimum thickness of base material.  
 3.If there is any question with packing specification or packing method, please contact your local CYStek sales office.

**Material:**

- Lead : Pure tin plated.
- Mold Compound: Epoxy resin family, flammability solid burning class: UL94V-0.

**Important Notice:**

- All rights are reserved. Reproduction in whole or in part is prohibited without the prior written approval of CYStek.
- CYStek reserves the right to make changes to its products without notice.
- CYStek **semiconductor products are not warranted to be suitable for use in Life-Support Applications, or systems.**
- CYStek assumes no liability for any consequence of customer product design, infringement of patents, or application assistance.