

**N-Channel Enhancement Mode Power MOSFET**

# MTD07N04J3

<b>BV<sub>DSS</sub></b>	<b>40V</b>
<b>I<sub>D</sub>@V<sub>GS</sub>=10V, T<sub>C</sub>=25°C</b>	<b>50A</b>
<b>R<sub>DS(ON)</sub>@V<sub>GS</sub>=10V, I<sub>D</sub>=20A</b>	<b>6.3 mΩ (typ)</b>
<b>R<sub>DS(ON)</sub>@V<sub>GS</sub>=4.5V, I<sub>D</sub>=10A</b>	<b>8.4 mΩ (typ)</b>

**Features**

- Low On Resistance
- Simple Drive Requirement
- Low Gate Charge
- Fast Switching Characteristic
- Pb-free lead plating and halogen-free package

**Symbol**

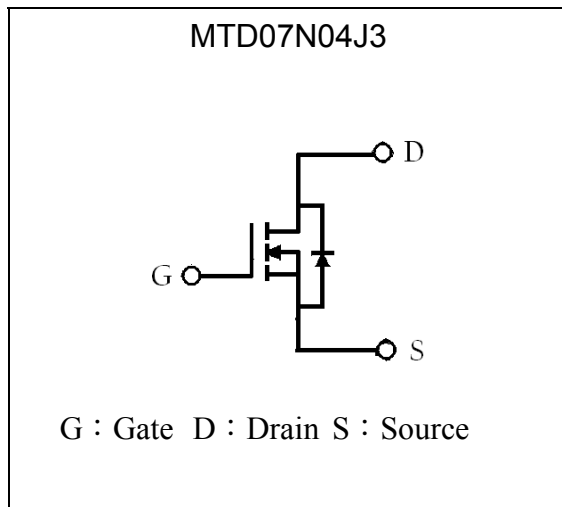

**Outline**

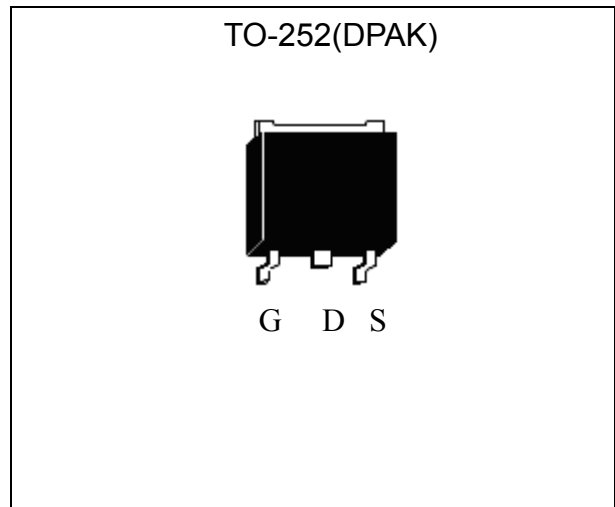

**Ordering Information**

Device	Package	Shipping
MTD07N04J3-0-T3-G	TO-252 (Pb-free lead plating and halogen-free package)	2500 pcs / tape& reel

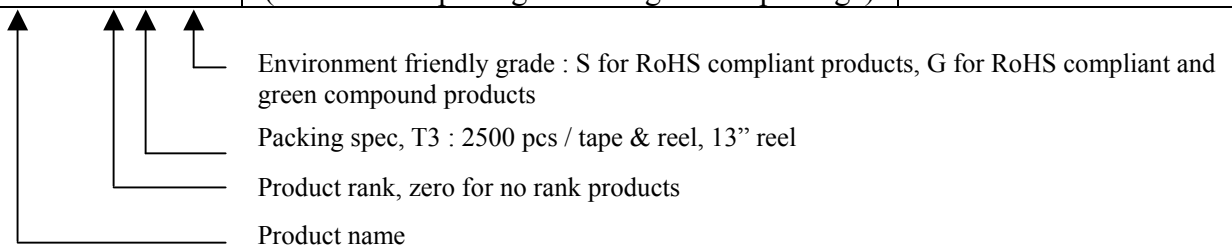

**Absolute Maximum Ratings** ( $T_C=25^{\circ}\text{C}$ )

Parameter	Symbol	Limits	Unit	
Drain-Source Voltage (Note 1)	$V_{DS}$	40	V	
Gate-Source Voltage	$V_{GS}$	$\pm 20$		
Continuous Drain Current @ $T_C=25^{\circ}\text{C}$ , $V_{GS}=10\text{V}$ (silicon limit) (Note 1)	$I_D$	63	A	
Continuous Drain Current @ $T_C=100^{\circ}\text{C}$ , $V_{GS}=10\text{V}$ (silicon limit) (Note 1)		40		
Continuous Drain Current @ $T_C=25^{\circ}\text{C}$ , $V_{GS}=10\text{V}$ (package limit) (Note 1)		50		
Continuous Drain Current @ $T_A=25^{\circ}\text{C}$ , $V_{GS}=10\text{V}$ (Note 2)	$I_{DSM}$	13.5		
Continuous Drain Current @ $T_A=70^{\circ}\text{C}$ , $V_{GS}=10\text{V}$ (Note 2)		10.8		
Pulsed Drain Current @ $V_{GS}=10\text{V}$ (Note 3)	$I_{DM}$	200		
Avalanche Current (Note 3)	$I_{AS}$	18		
Single Pulse Avalanche Energy @ $L=0.5\text{mH}$ , $I_D=18\text{A}$ , $V_{DD}=25\text{V}$	$E_{AS}$	81	mJ	
Power Dissipation	$P_D$	$T_C=25^{\circ}\text{C}$ (Note 1)	54	W
		$T_C=100^{\circ}\text{C}$ (Note 1)	21	
	$P_{DSM}$	$T_A=25^{\circ}\text{C}$ (Note 2)	2.5	
		$T_A=70^{\circ}\text{C}$ (Note 2)	1.6	
Operating Junction and Storage Temperature	$T_j, T_{stg}$	-55~+150	$^{\circ}\text{C}$	

**Thermal Data**

Parameter	Symbol	Value	Unit
Thermal Resistance, Junction-to-case, max	$R_{\theta JC}$	2.3	$^{\circ}\text{C}/\text{W}$
Thermal Resistance, Junction-to-ambient, max (Note 2)	$R_{\theta JA}$	50	

- Note : 1. The power dissipation  $P_D$  is based on  $T_{J(MAX)}=150^{\circ}\text{C}$ , using junction-to-case thermal resistance, and is more useful in setting the upper dissipation limit for cases where additional heatsinking is used.
2. The value of  $R_{\theta JA}$  is measured with the device mounted on 1 in<sup>2</sup> FR-4 board with 2 oz. copper, in a still air environment with  $T_A=25^{\circ}\text{C}$ . The power dissipation  $P_{DSM}$  is based on  $R_{\theta JA}$  and the maximum allowed junction temperature of  $150^{\circ}\text{C}$ .
3. Pulse width limited by junction temperature  $T_{J(MAX)}=150^{\circ}\text{C}$ . Ratings are based on low frequency and low duty cycles to keep initial  $T_j=25^{\circ}\text{C}$ .

**Characteristics (T<sub>j</sub>=25°C, unless otherwise specified)**

Symbol	Min.	Typ.	Max.	Unit	Test Conditions
<b>Static</b>					
BV <sub>DSS</sub>	40	-	-	V	V <sub>GS</sub> =0V, I <sub>D</sub> =250μA
ΔBV <sub>DSS</sub> /ΔT <sub>j</sub>	-	0.03	-	V/°C	Reference to 25°C, I <sub>D</sub> =250μA
V <sub>GS(th)</sub>	1.5	-	2.5	V	V <sub>DS</sub> = V <sub>GS</sub> , I <sub>D</sub> =250μA
*G <sub>FS</sub>	-	22	-	S	V <sub>DS</sub> = 5V, I <sub>D</sub> =10A
I <sub>GSS</sub>	-	-	±100	nA	V <sub>GS</sub> =±20V
I <sub>DSS</sub>	-	-	1	μA	V <sub>DS</sub> = 32V, V <sub>GS</sub> = 0V
	-	-	10		V <sub>DS</sub> = 32V, V <sub>GS</sub> = 0V, T <sub>j</sub> =85°C
*R <sub>DS(ON)</sub>	-	6.3	7.6	mΩ	V <sub>GS</sub> = 10V, I <sub>D</sub> =20A
	-	8.4	10		V <sub>GS</sub> = 4.5V, I <sub>D</sub> =10A
<b>Dynamic</b>					
*Q <sub>g</sub> (V <sub>GS</sub> =10V)	-	31	46.5	nC	V <sub>DD</sub> =20V, I <sub>D</sub> =20A, V <sub>GS</sub> =10V
*Q <sub>g</sub> (V <sub>GS</sub> =4.5V)	-	15.7	-		
*Q <sub>gs</sub>	-	6	-		
*Q <sub>gd</sub>	-	7	-		
*t <sub>d(ON)</sub>	-	14.6	-	ns	V <sub>DD</sub> =20V, I <sub>D</sub> =1A, V <sub>GS</sub> =10V, R <sub>G</sub> =1Ω
*t <sub>r</sub>	-	18.8	-		
*t <sub>d(OFF)</sub>	-	43.4	-		
*t <sub>f</sub>	-	8	-		
C <sub>iss</sub>	-	1517	-	pF	V <sub>GS</sub> =0V, V <sub>DS</sub> =20V, f=1MHz
C <sub>oss</sub>	-	188	-		
C <sub>rss</sub>	-	116	-		
R <sub>g</sub>	-	1.6	-	Ω	f=1MHz
<b>Source-Drain Diode</b>					
*I <sub>S</sub>	-	-	50	A	
*V <sub>SD</sub>	-	0.86	1.1	V	I <sub>S</sub> =20A, V <sub>GS</sub> =0V
*t <sub>rr</sub>	-	14	-	ns	V <sub>GS</sub> =0, I <sub>F</sub> =20A, dI <sub>F</sub> /dt=360A/μs
*Q <sub>rr</sub>	-	8.6	-	nC	

\*Pulse Test : Pulse Width ≤300μs, Duty Cycle≤2%

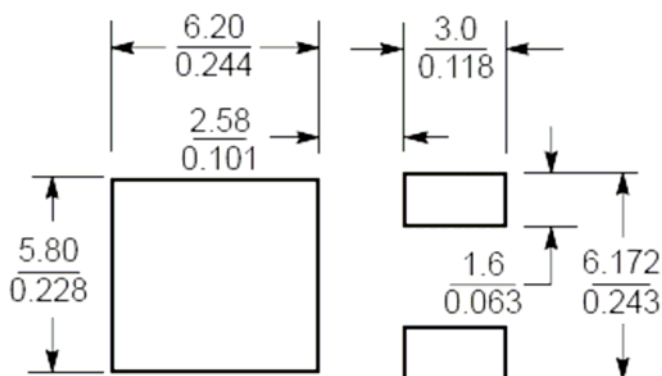
**Recommended soldering footprint**

 Unit (  $\frac{\text{mm}}{\text{inch}}$  )

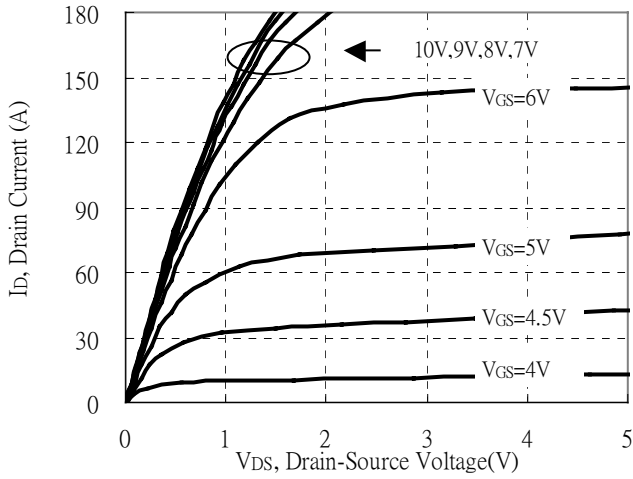

**Typical Characteristics**

Typical Output Characteristics



Brekdown Voltage vs Ambient Temperature

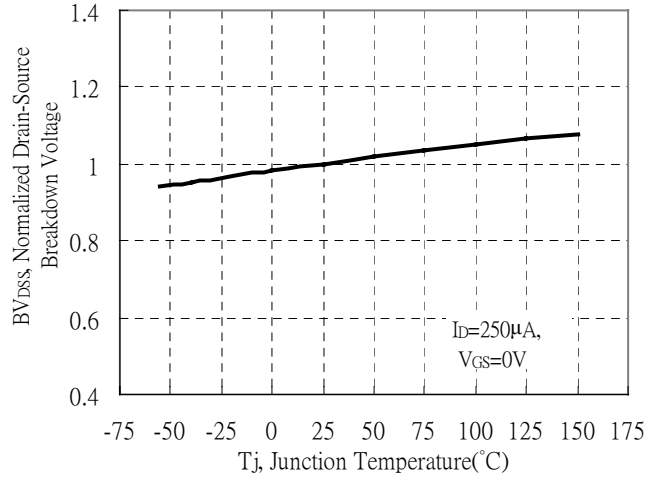

Static Drain-Source On-State resistance vs Drain Current

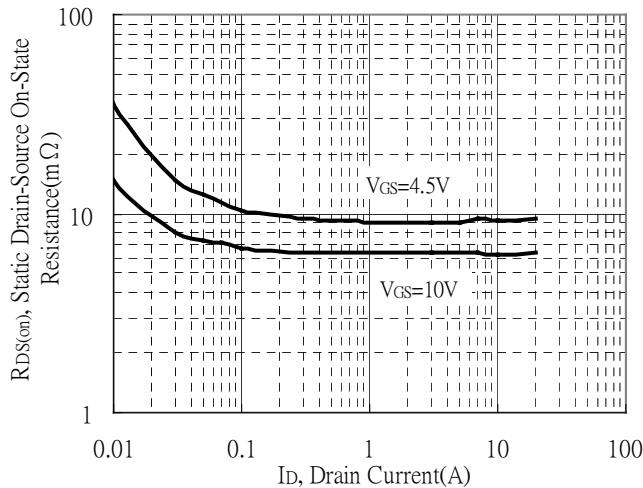

Reverse Drain Current vs Source-Drain Voltage

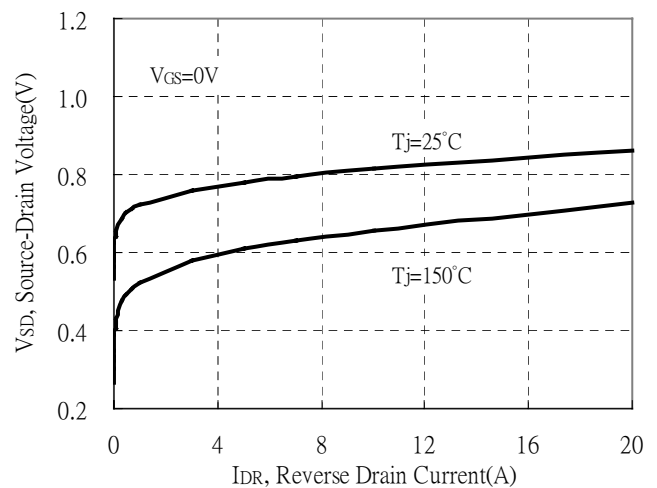

Static Drain-Source On-State Resistance vs Gate-Source Voltage

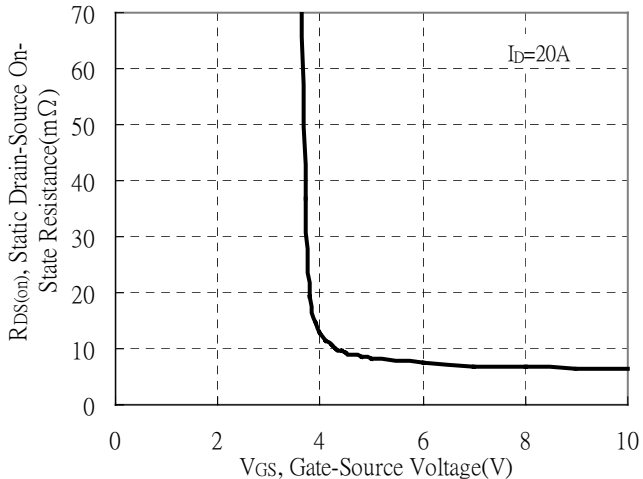

Drain-Source On-State Resistance vs Junction Temperature

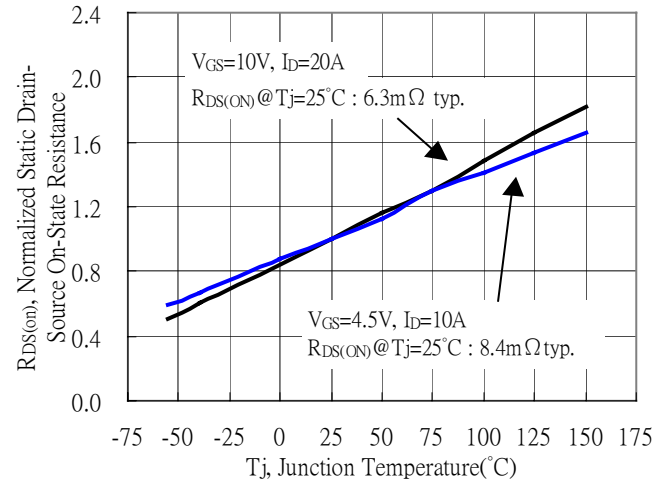



**Typical Characteristics(Cont.)**

Capacitance vs Drain-to-Source Voltage

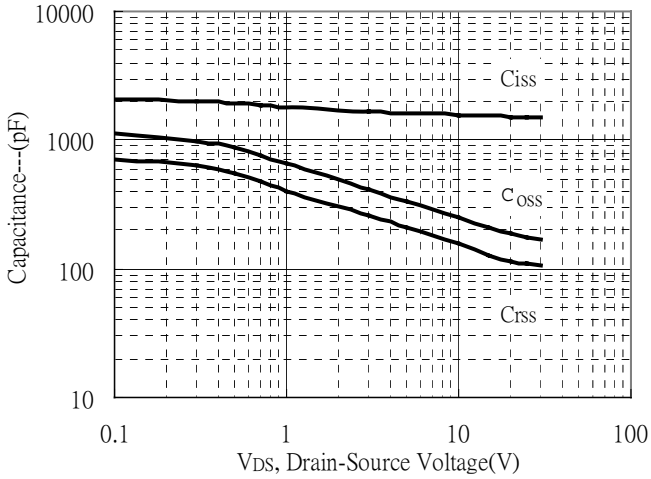

Threshold Voltage vs Junction Temperature

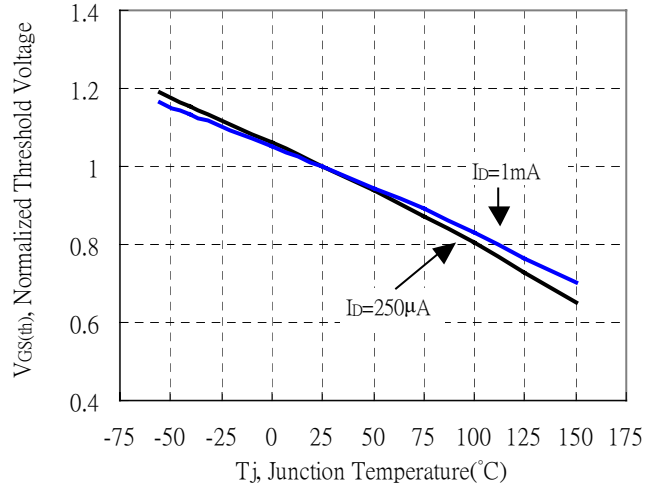

Forward Transfer Admittance vs Drain Current

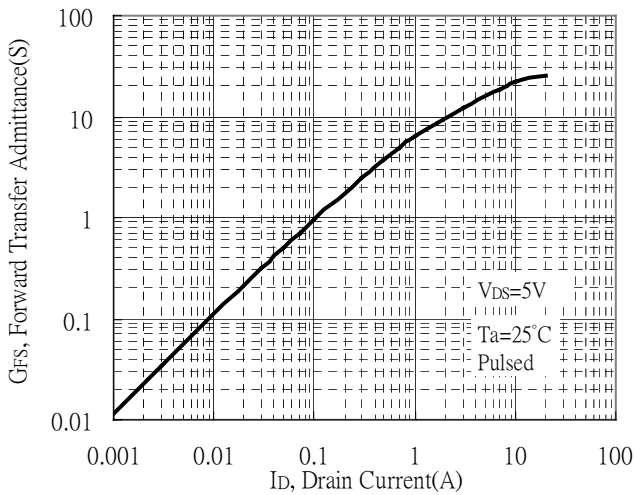

Gate Charge Characteristics

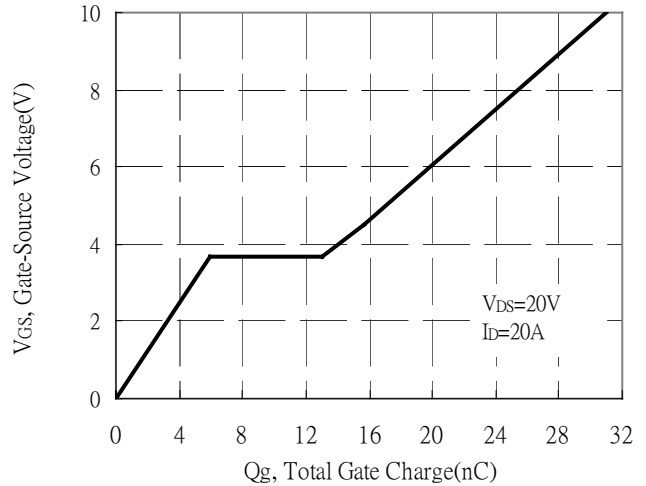

Maximum Safe Operating Area

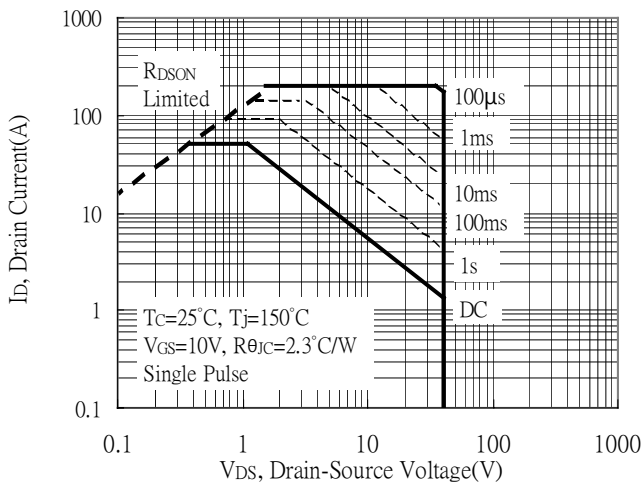

Maximum Drain Current vs Case Temperature

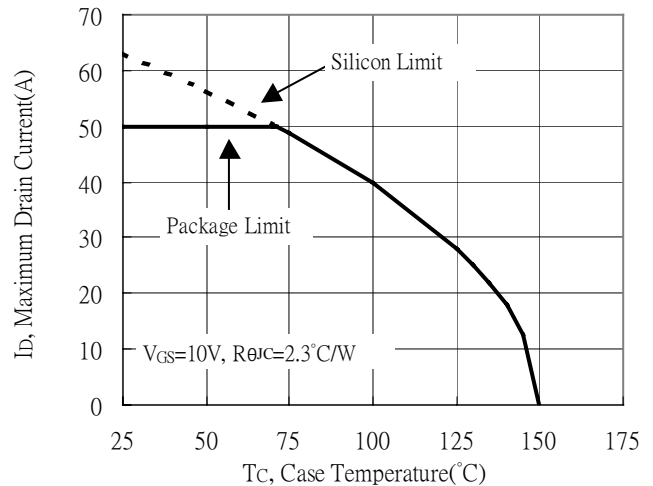



**Typical Characteristics(Cont.)**

Typical Transfer Characteristics

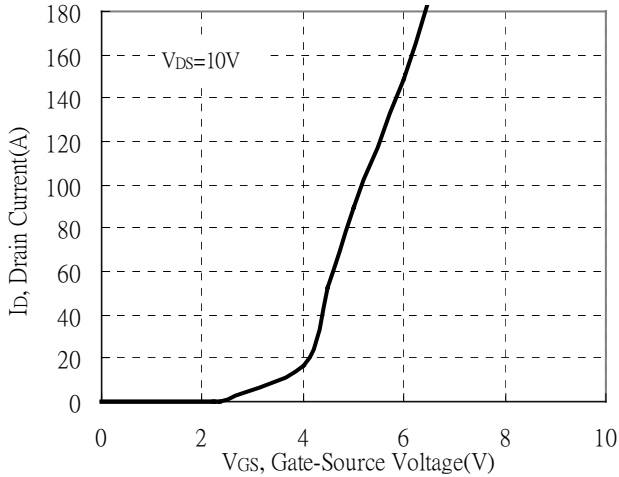

Single Pulse Power Rating, Junction to Case

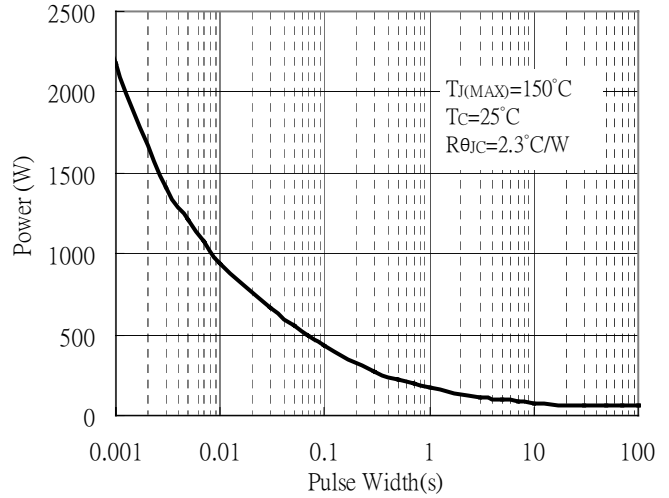

Transient Thermal Response Curves

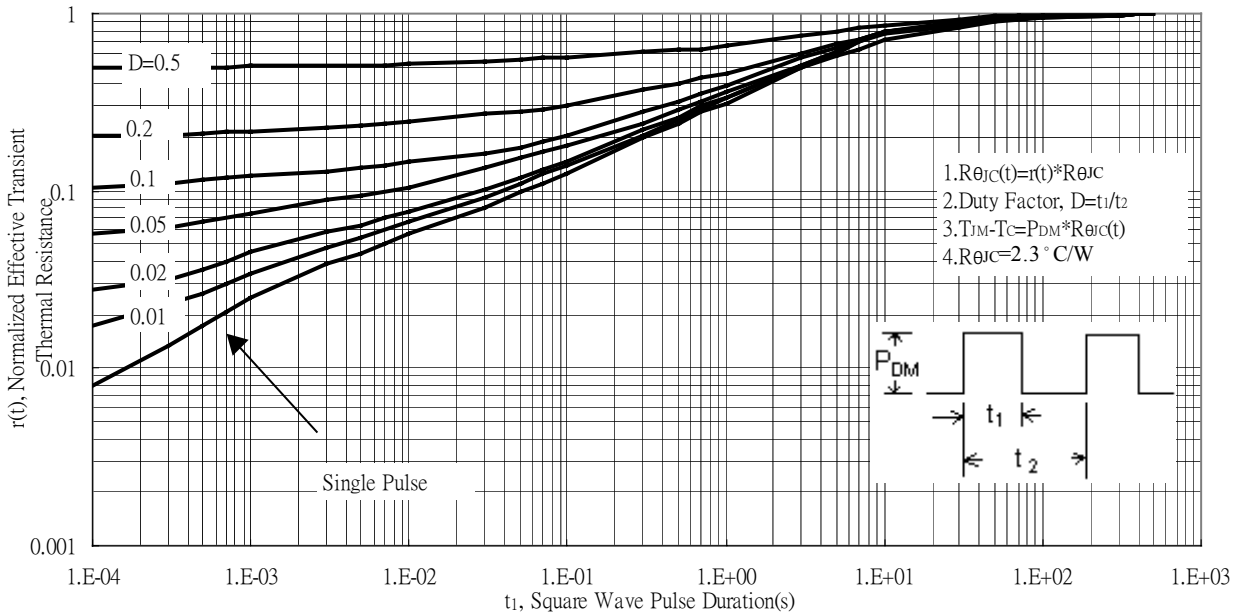

### Reel Dimension

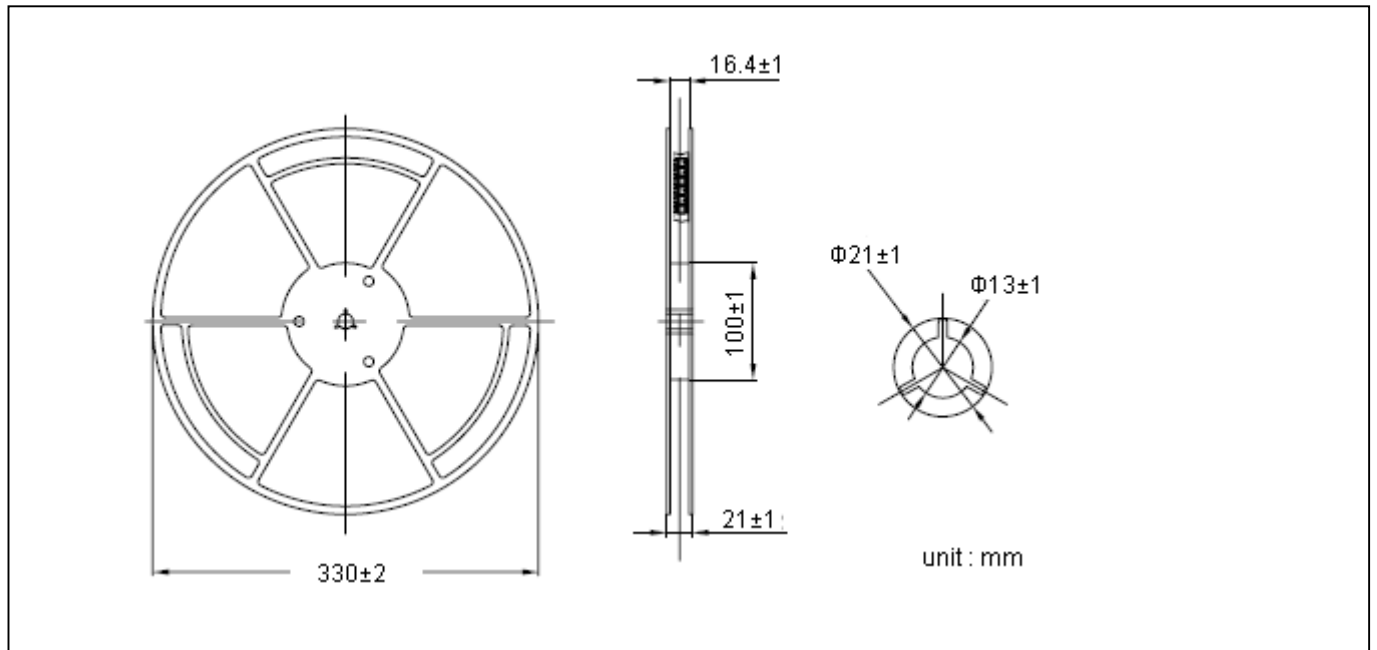

### Carrier Tape Dimension

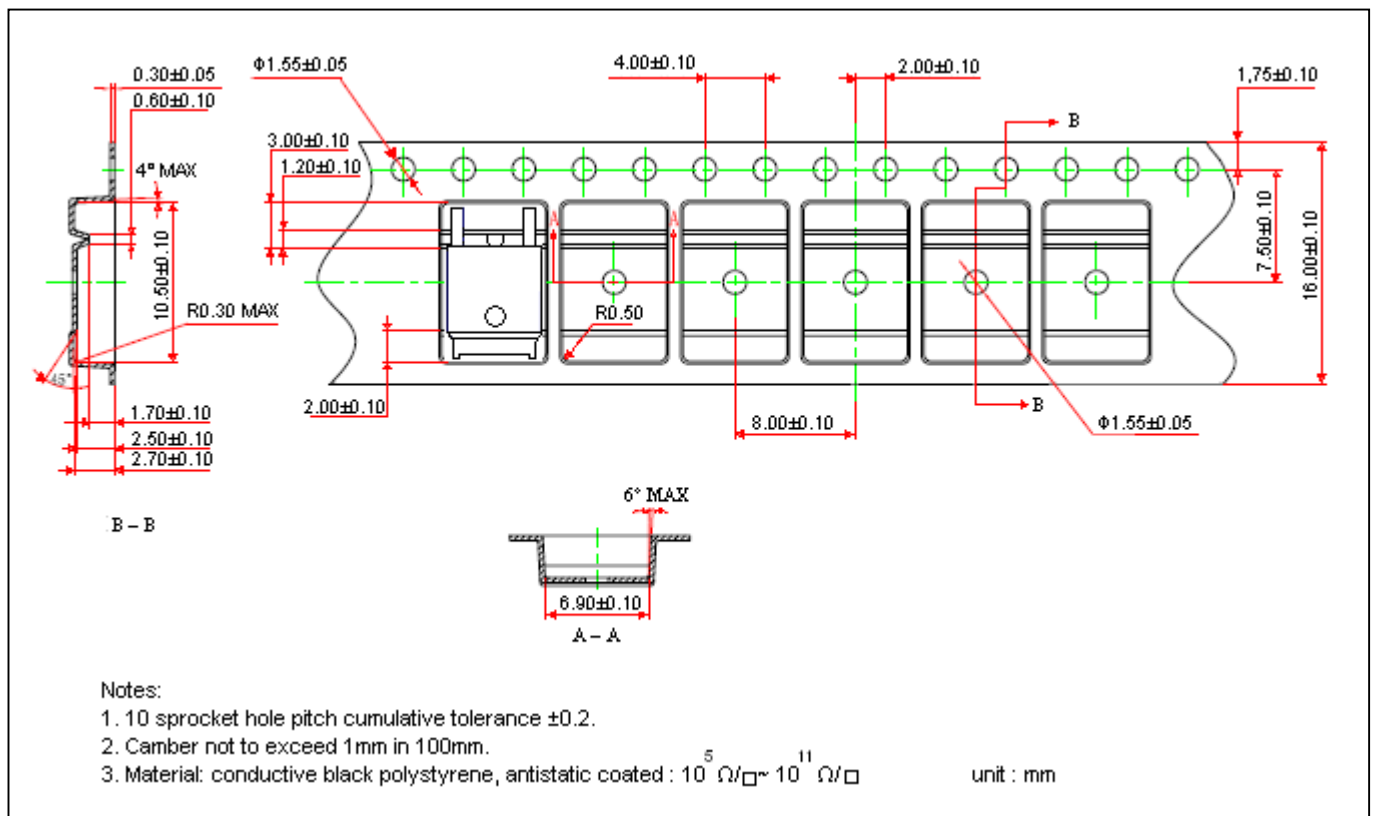

**Recommended wave soldering condition**

Product	Peak Temperature	Soldering Time
Pb-free devices	260 +0/-5 °C	5 +1/-1 seconds

**Recommended temperature profile for IR reflow**

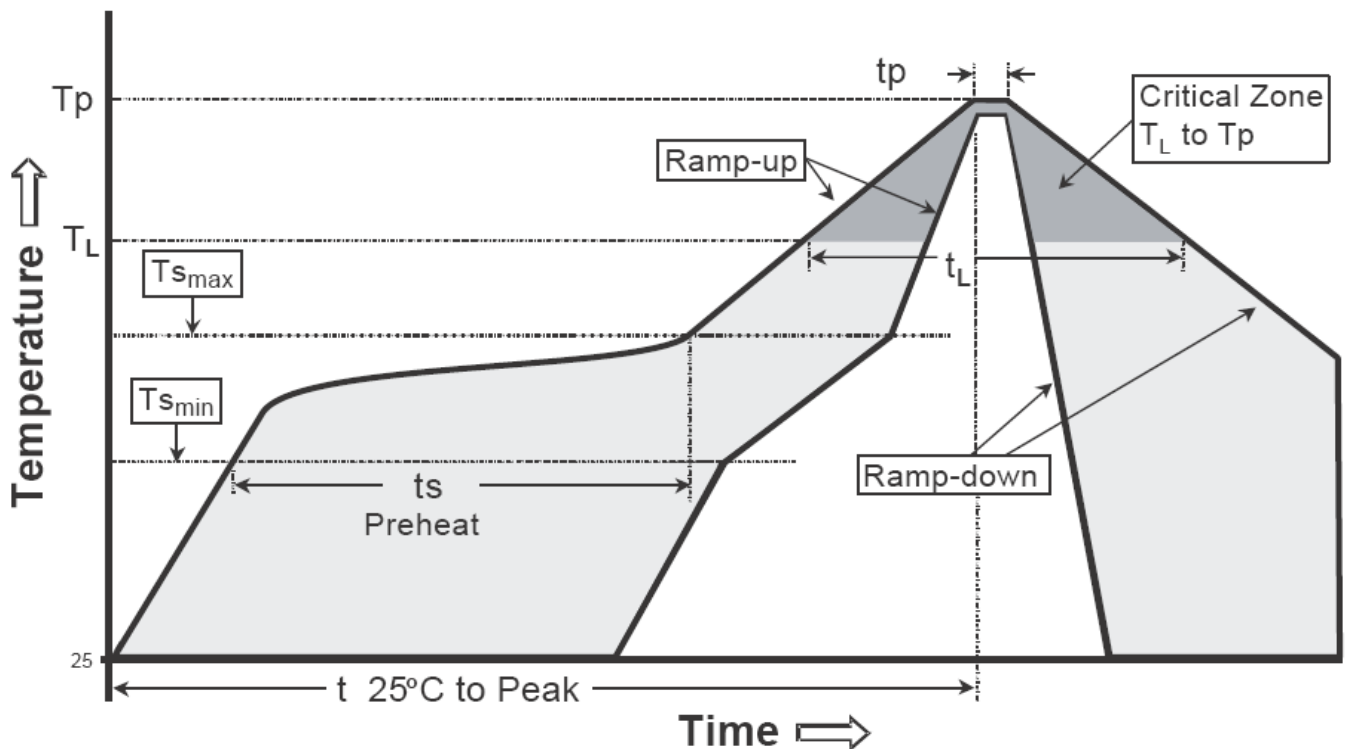

Profile feature	Sn-Pb eutectic Assembly	Pb-free Assembly
Average ramp-up rate (T <sub>smax</sub> to T <sub>p</sub> )	3°C/second max.	3°C/second max.
Preheat		
-Temperature Min(T <sub>s min</sub> )	100°C	150°C
-Temperature Max(T <sub>s max</sub> )	150°C	200°C
-Time(t <sub>s min</sub> to t <sub>s max</sub> )	60-120 seconds	60-180 seconds
Time maintained above:		
-Temperature (T <sub>L</sub> )	183°C	217°C
- Time (t <sub>L</sub> )	60-150 seconds	60-150 seconds
Peak Temperature(T <sub>p</sub> )	240 +0/-5 °C	260 +0/-5 °C
Time within 5°C of actual peak temperature(t <sub>p</sub> )	10-30 seconds	20-40 seconds
Ramp down rate	6°C/second max.	6°C/second max.
Time 25 °C to peak temperature	6 minutes max.	8 minutes max.

Note : All temperatures refer to topside of the package, measured on the package body surface.



**TO-252 Dimension**

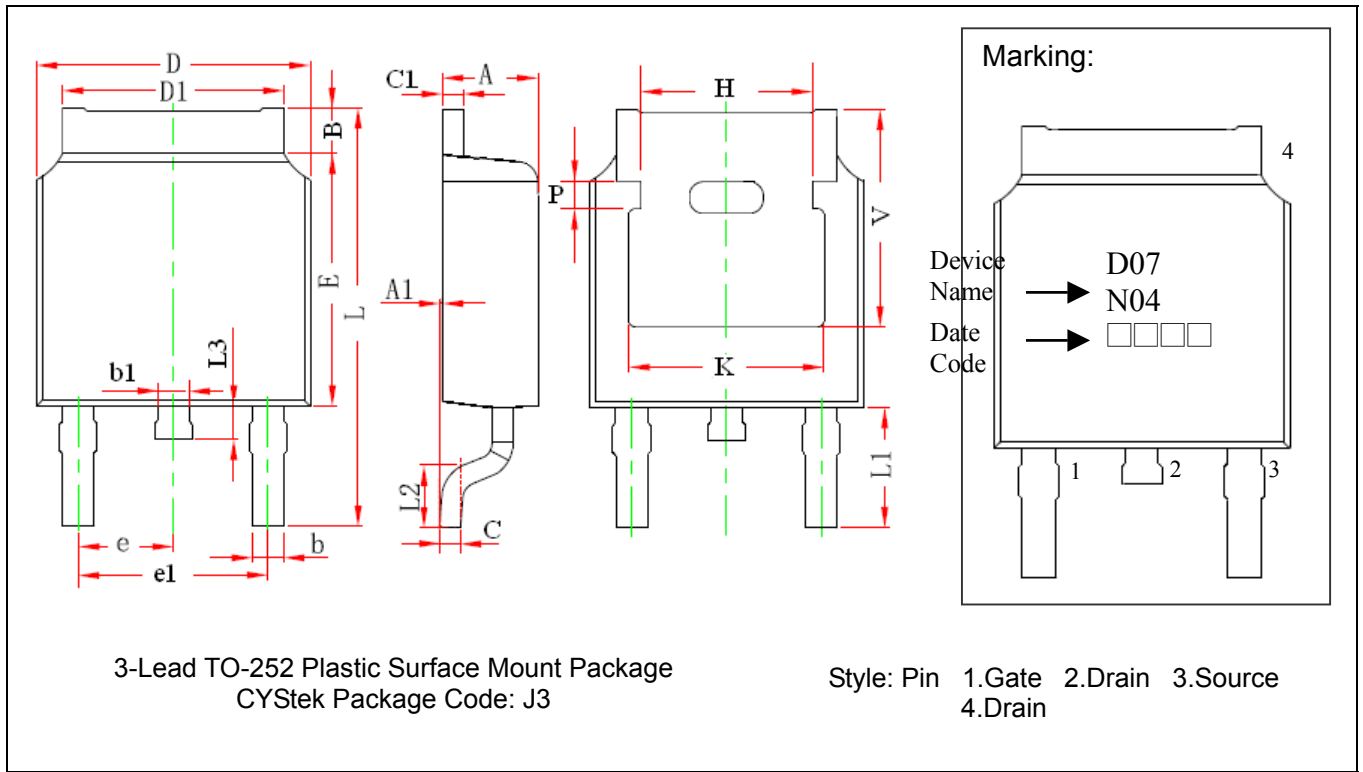

DIM	Inches		Millimeters		DIM	Inches		Millimeters	
	Min.	Max.	Min.	Max.		Min.	Max.	Min.	Max.
A	0.087	0.094	2.200	2.400	e	0.086	0.094	2.186	2.386
A1	0.000	0.005	0.000	0.127	e1	0.172	0.188	4.372	4.772
B	0.039	0.048	0.990	1.210	H	0.163	REF	4.140	REF
b	0.026	0.034	0.660	0.860	K	0.190	REF	4.830	REF
b1	0.026	0.034	0.660	0.860	L	0.386	0.409	9.800	10.400
C	0.018	0.023	0.460	0.580	L1	0.114	REF	2.900	REF
C1	0.018	0.023	0.460	0.580	L2	0.055	0.067	1.400	1.700
D	0.256	0.264	6.500	6.700	L3	0.024	0.039	0.600	1.000
D1	0.201	0.215	5.100	5.460	P	0.026	REF	0.650	REF
E	0.236	0.244	6.000	6.200	V	0.211	REF	5.350	REF

- Notes:**
- Controlling dimension: millimeters.
  - Maximum lead thickness includes lead finish thickness, and minimum lead thickness is the minimum thickness of base material.
  - If there is any question with packing specification or packing method, please contact your local CYStek sales office.

**Material:**

- Lead : Pure tin plated.
- Mold Compound: Epoxy resin family, flammability solid burning class: UL94V-0.

**Important Notice:**

- All rights are reserved. Reproduction in whole or in part is prohibited without the prior written approval of CYStek.
- CYStek reserves the right to make changes to its products without notice.
- CYStek **semiconductor products are not warranted to be suitable for use in Life-Support Applications, or systems.**
- CYStek assumes no liability for any consequence of customer product design, infringement of patents, or application assistance.