

2N- and 2P-Channel Enhancement Mode MOSFET

MTC9930Q8

	N-CH	P-CH
BV _{DSS}	30V	-30V
I _D	6A	-4.4A
R _{DSON} (TYP.)	17mΩ	35mΩ

Description

The MTC9930Q8 consists of two N-channel and two P-channel enhancement-mode MOSFET in a single SOP-8 package, providing the designer with the best combination of fast switching, ruggedized device design, low on-resistance and cost-effectiveness.

The SOP-8 package is universally preferred for all commercial-industrial surface mount applications.

Features

- Simple drive requirement
- Low on-resistance
- Fast switching speed
- Pb-free lead plating and halogen-free package

Equivalent Circuit

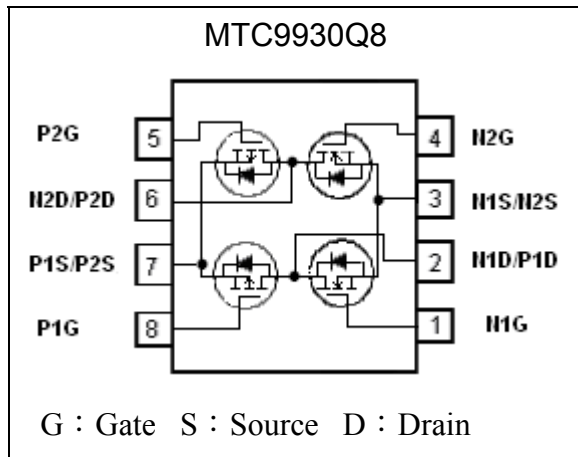

Outline

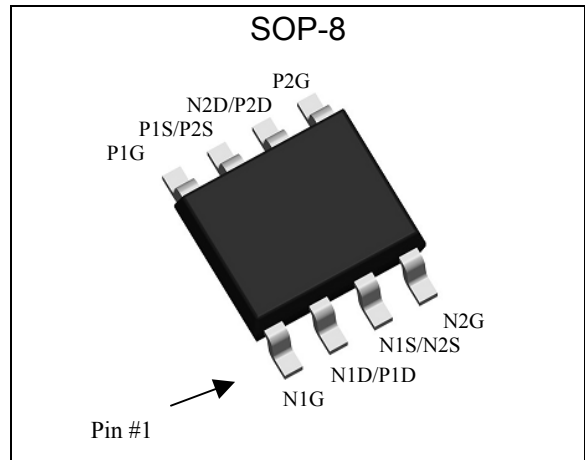

Ordering Information

Device	Package	Shipping
MTC9930Q8-0-T3-G	SOP-8 (Pb-free lead plating and halogen-free package)	2500 pcs / tape & reel

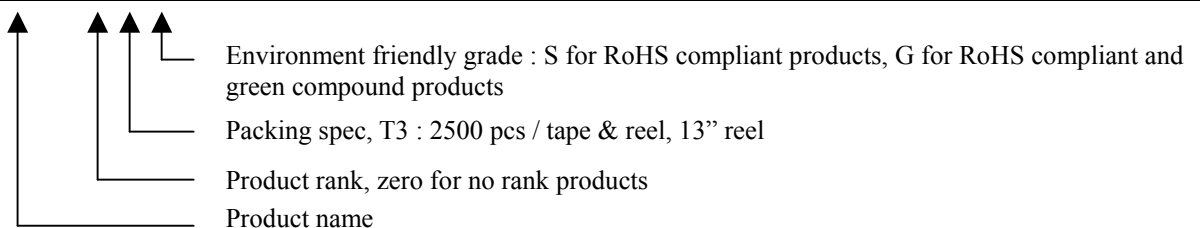



Absolute Maximum Ratings (T_C=25°C, unless otherwise noted)

Parameter	Symbol	Limits		Unit
		N-channel	P-channel	
Drain-Source Breakdown Voltage	BV _{DSS}	30	-30	V
Gate-Source Voltage	V _{GS}	±25	±25	
Continuous Drain Current (Note 2)	I _D	T _A =25 °C, V _{GS} =10V (-10V)	6	A
		T _A =70 °C, V _{GS} =10V (-10V)	4.8	
Pulsed Drain Current (Note 1)	I _{DM}	24	-20	
Power Dissipation	P _D	T _A =25°C	1.38	W
		T _A =70°C	0.88	
Operating Junction and Storage Temperature Range	T _j ; T _{stg}	-55~+150		°C

Thermal Data

Parameter	Symbol	Value	Unit
Thermal Resistance, Junction-to-case, max	R _{θJC}	36	°C/W
Thermal Resistance, Junction-to-ambient, max	R _{θJA}	90 (Note 2)	

Note : 1.Pulse width limited by maximum junction temperature.
 2.Surface mounted on 1 in² copper pad of FR-4 board, pulse width≤10s.

N-Channel Electrical Characteristics (T_C=25°C, unless otherwise specified)

Symbol	Min.	Typ.	Max.	Unit	Test Conditions
Static					
BV _{DSS}	30	-	-	V	V _{GS} =0V, I _D =250μA
V _{GS(th)}	1.0	-	2.5		V _{DS} =V _{GS} , I _D =250μA
I _{GSS}	-	-	±100	nA	V _{GS} =±25V, V _{DS} =0V
I _{DSS}	-	-	1	μA	V _{DS} =30V, V _{GS} =0V
	-	-	25		V _{DS} =24V, V _{GS} =0V, T _j =70°C
*R _{Ds(ON)}	-	17	24	mΩ	I _D =5A, V _{GS} =10V
	-	21	30		I _D =3A, V _{GS} =4.5V
*G _{FS}	-	6.7	-	S	V _{DS} =5V, I _D =5A
Dynamic					
C _{iss}	-	496	750	pF	V _{DS} =25V, V _{GS} =0V, f=1MHz
C _{oss}	-	61	-		
C _{rss}	-	47	-		
*t _{d(ON)}	-	6.2	-	ns	V _{DS} =15V, I _D =1A, V _{GS} =10V, R _G =6Ω
*t _r	-	17.2	-		
*t _{d(OFF)}	-	30.2	-		
*t _f	-	7.6	-		
*Q _g	-	5.6	9	nC	V _{DS} =15V, I _D =6A, V _{GS} =4.5V
*Q _{gs}	-	1.9	-		
*Q _{gd}	-	2.1	-		
Body Diode					
*V _{SD}	-	0.78	1.2	V	V _{GS} =0V, I _S =1.2A
*t _{rr}	-	7.7	-	ns	I _F =5A, dI _F /dt=100A/μs
*Q _{rr}	-	3.3	-	nC	

*Pulse Test : Pulse Width ≤300μs, Duty Cycle≤2%

P-Channel Electrical Characteristics (Tc=25°C, unless otherwise specified)

Symbol	Min.	Typ.	Max.	Unit	Test Conditions
Static					
BV _{DSS}	-30	-	-	V	V _{GS} =0V, I _D =-250μA
V _{GS(th)}	-1.0	-	-2.5		V _{DS} =V _{GS} , I _D =-250μA
I _{GSS}	-	-	±100	nA	V _{GS} =±25V, V _{DS} =0V
I _{DSS}	-	-	-1	μA	V _{DS} =-30V, V _{GS} =0V
	-	-	-25		V _{DS} =-24V, V _{GS} =0V, T _J =70°C
*R _{DS(ON)}	-	35	48	mΩ	I _D =-4A, V _{GS} =-10V
	-	46	70		I _D =-2A, V _{GS} =-4.5V
*G _{FS}	-	7.8	-	S	V _{DS} =-10V, I _D =-5A
Dynamic					
C _{iss}	-	597	900	pF	V _{DS} =-25V, V _{GS} =0V, f=1MHz
C _{oss}	-	63	-		
C _{rss}	-	51	-		
*t _{d(ON)}	-	5.6	-	ns	V _{DS} =-15V, I _D =-1A, V _{GS} =-10V, R _G =6Ω
*t _r	-	17.6	-		
*t _{d(OFF)}	-	64.4	-		
*t _f	-	33.8	-		
*Q _g	-	6.7	11	nC	V _{DS} =-15V, I _D =-4.4A, V _{GS} =-4.5V
*Q _{gs}	-	2.2	-		
*Q _{gd}	-	2.5	-		
Body Diode					
*V _{SD}	-	-0.78	-1.2	V	V _{GS} =0V, I _S =-1.2A
*t _{rr}	-	7.7	-	ns	I _F =-4.5A, dI _F /dt=100A/μs
*Q _{rr}	-	3.0	-	nC	

*Pulse Test : Pulse Width ≤300μs, Duty Cycle≤2%

Recommended Soldering Footprint

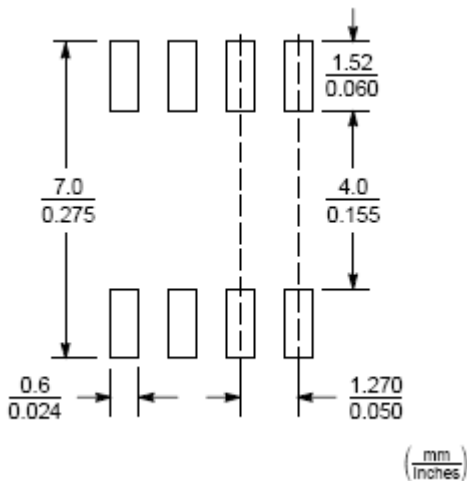



Typical Characteristics : Q1(N-channel)

Typical Output Characteristics

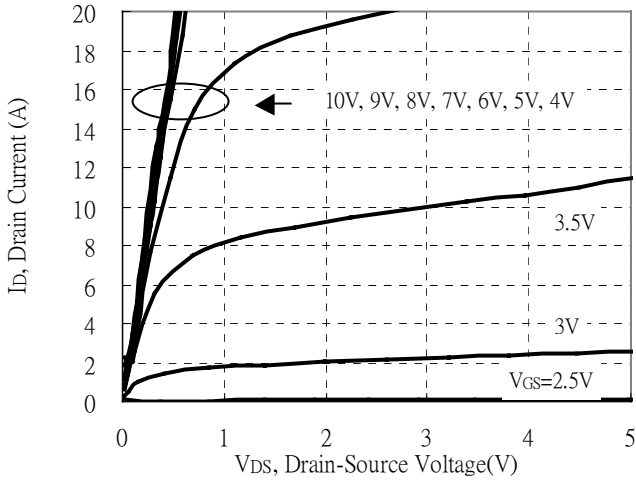

Brekdown Voltage vs Ambient Temperature

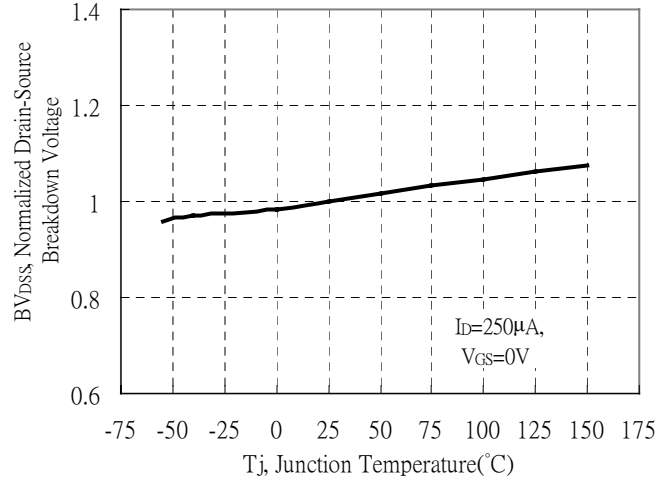

Static Drain-Source On-State resistance vs Drain Current

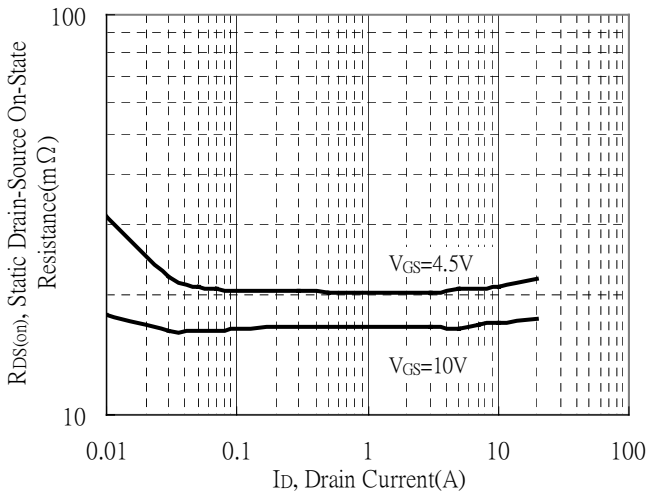

Reverse Drain Current vs Source-Drain Voltage

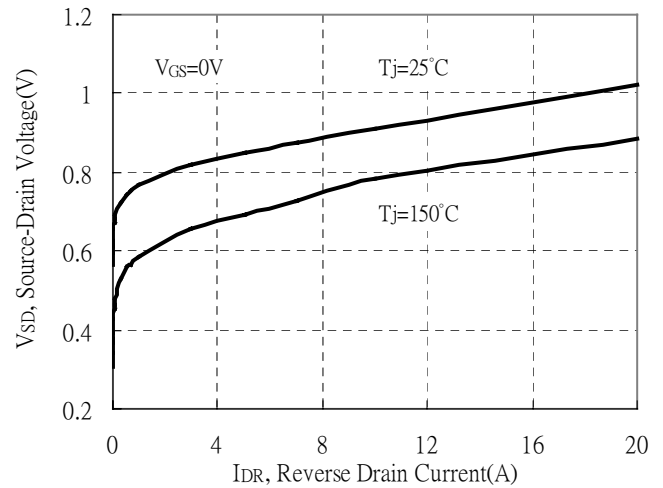

Static Drain-Source On-State Resistance vs Gate-Source Voltage

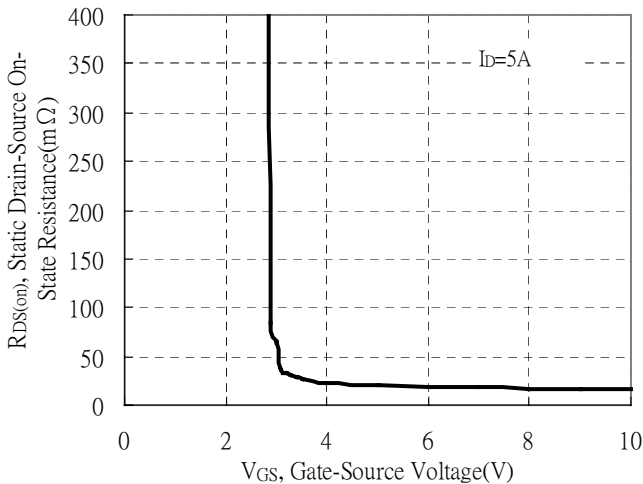

Drain-Source On-State Resistance vs Junction Temperature

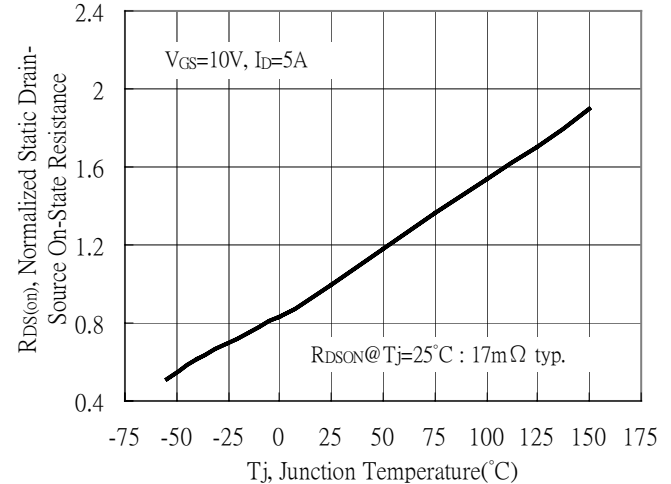

Typical Characteristics(Cont.) : Q1(N-channel)

Capacitance vs Drain-to-Source Voltage

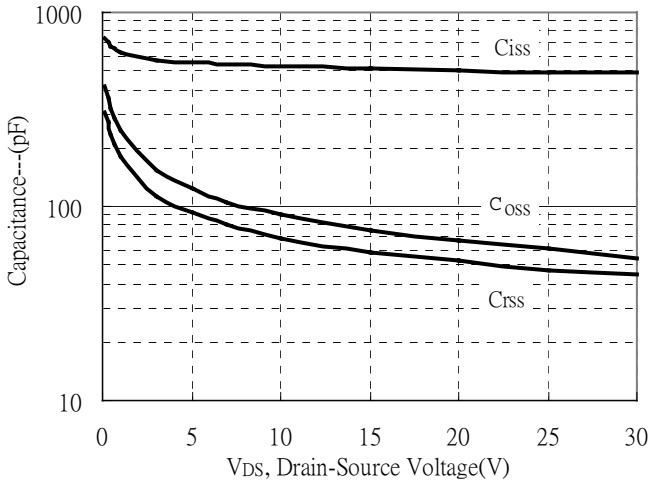

Threshold Voltage vs Junction Temperature

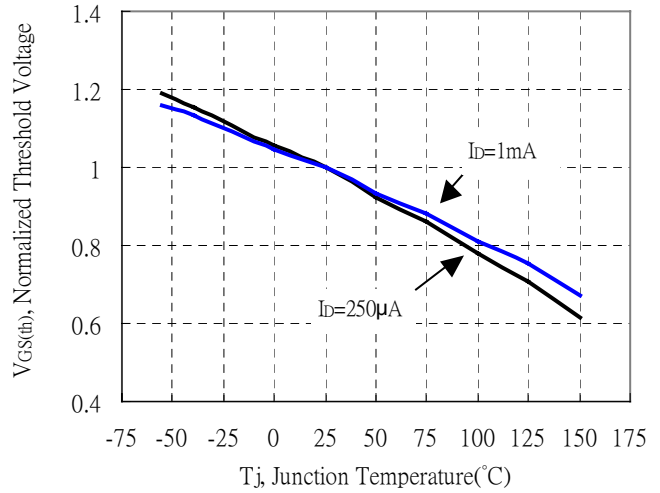

Forward Transfer Admittance vs Drain Current

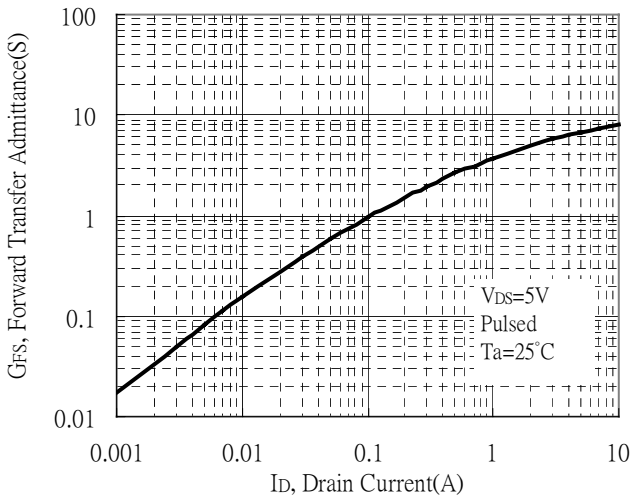

Gate Charge Characteristics

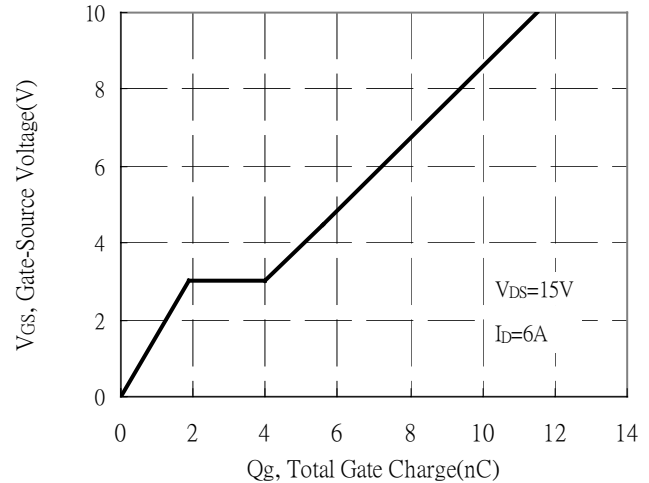

Maximum Safe Operating Area

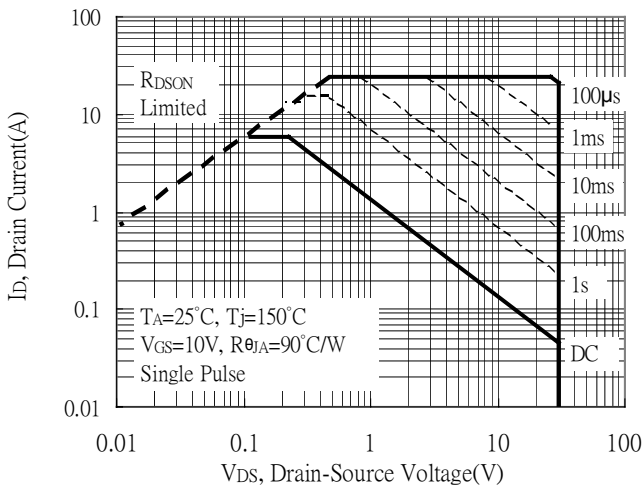

Maximum Drain Current vs Junction Temperature

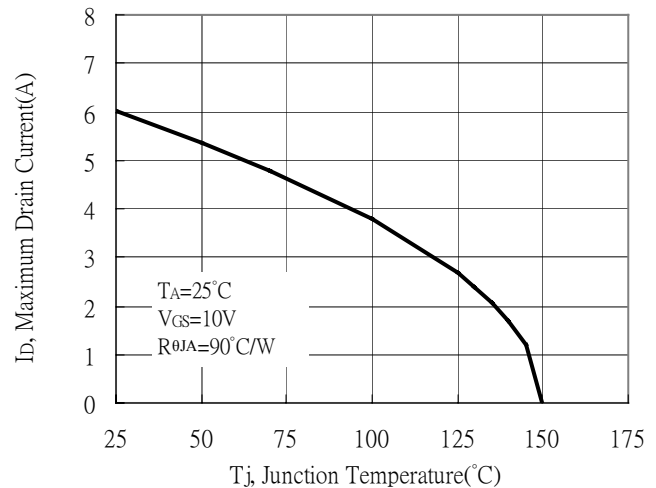

Typical Characteristics(Cont.) : Q1(N-channel)

Single Pulse Power Rating, Junction to Ambient
 (Note on page 2)

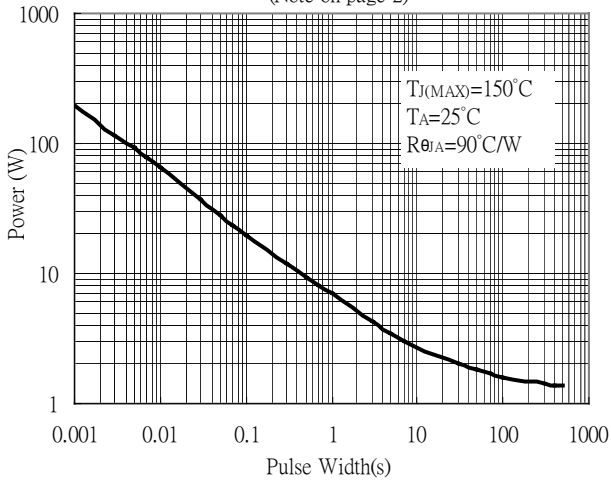

Typical Transfer Characteristics

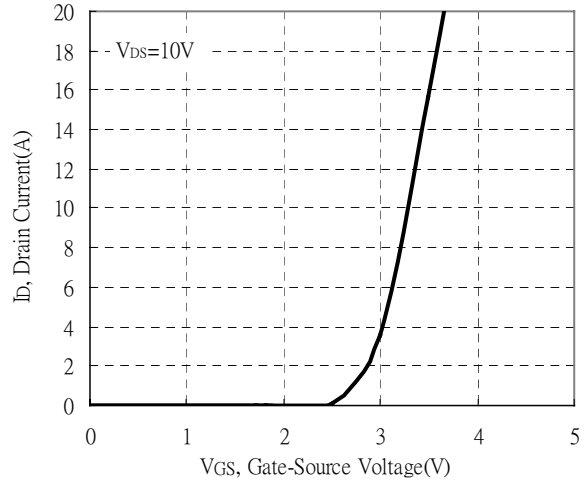

Transient Thermal Response Curves

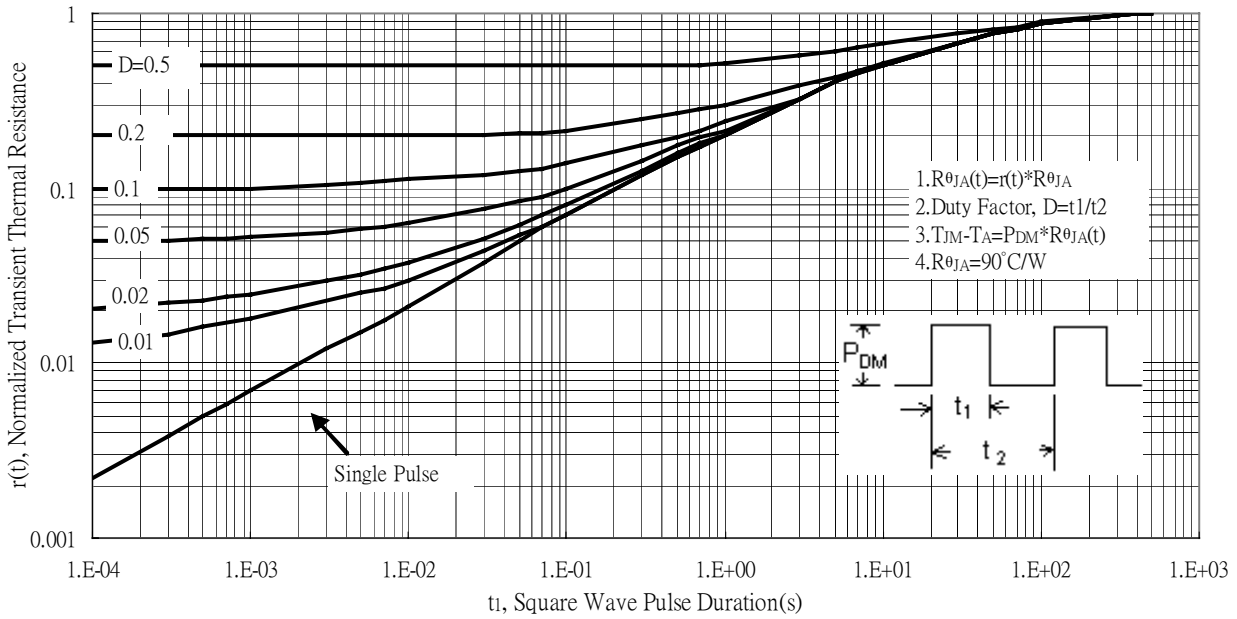

Typical Characteristics : Q2(P-channel)

Typical Output Characteristics

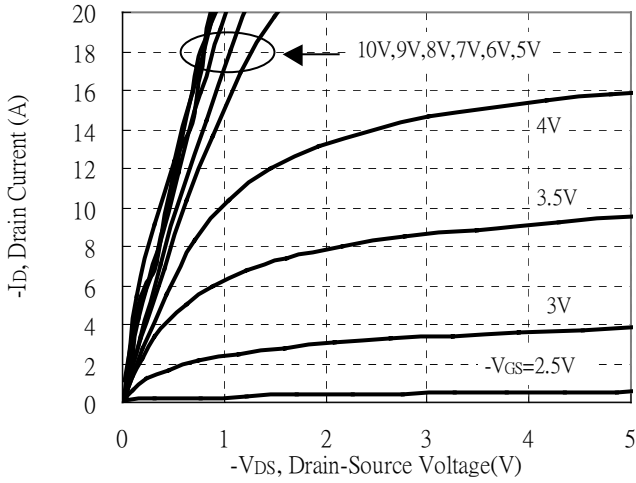

Brekdown Voltage vs Ambient Temperature

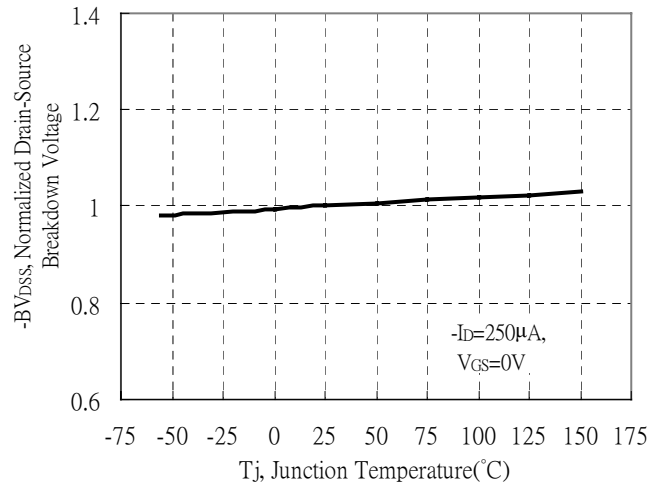

Static Drain-Source On-State resistance vs Drain Current

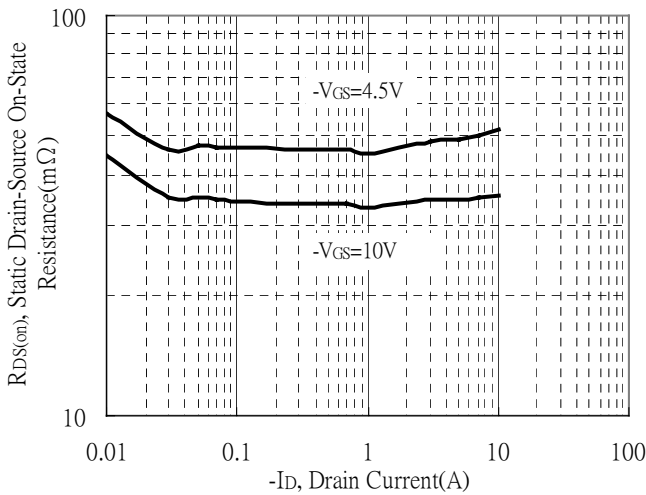

Reverse Drain Current vs Source-Drain Voltage

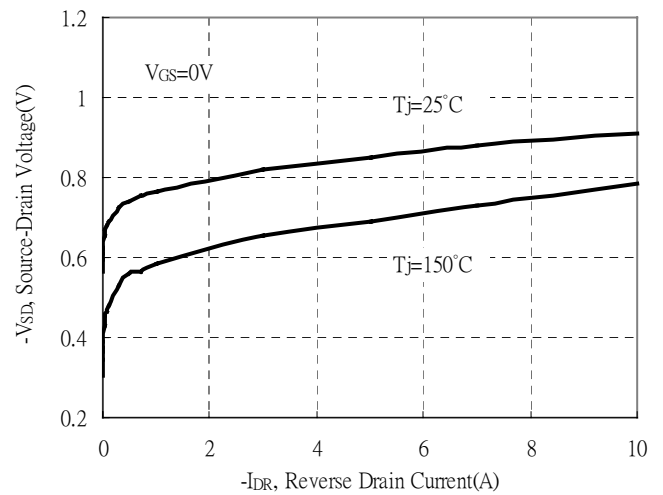

Static Drain-Source On-State Resistance vs Gate-Source Voltage

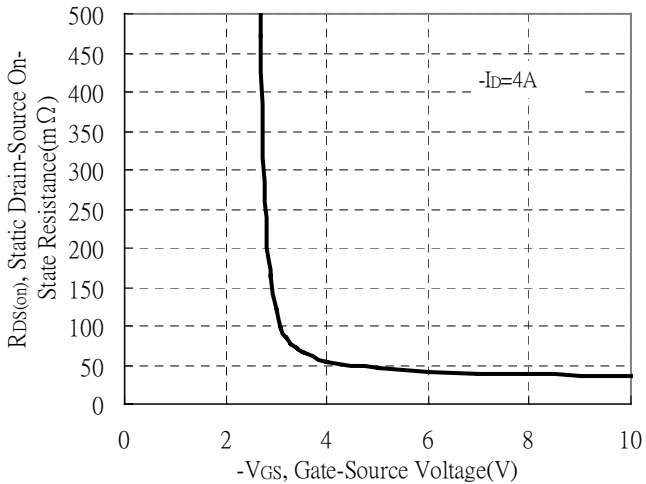

Drain-Source On-State Resistance vs Junction Temperature

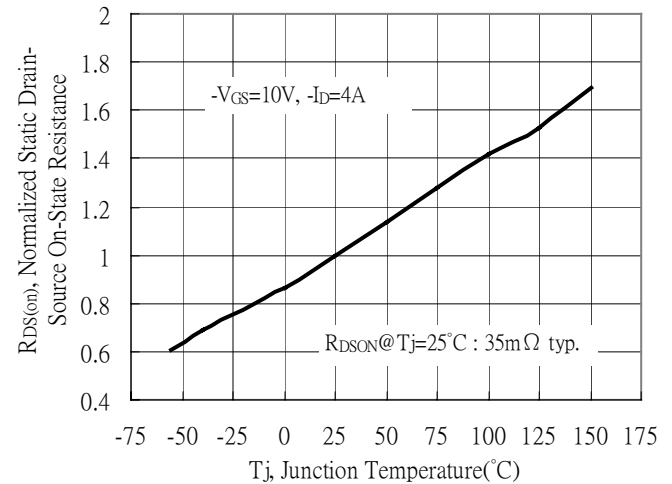

Typical Characteristics(Cont.) : Q2(P-channel)

Capacitance vs Drain-to-Source Voltage

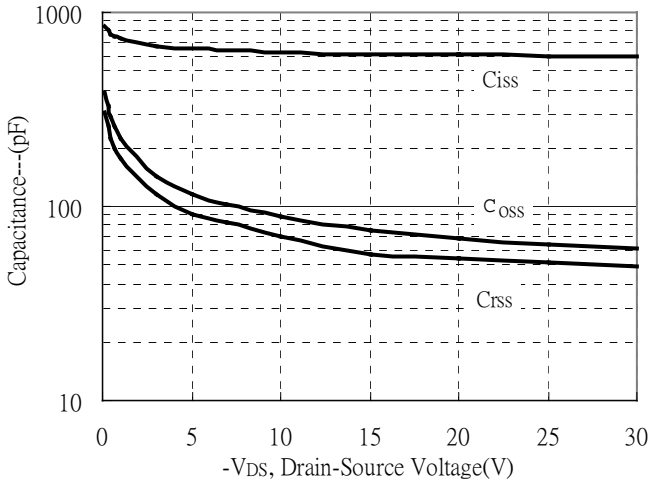

Threshold Voltage vs Junction Temperature

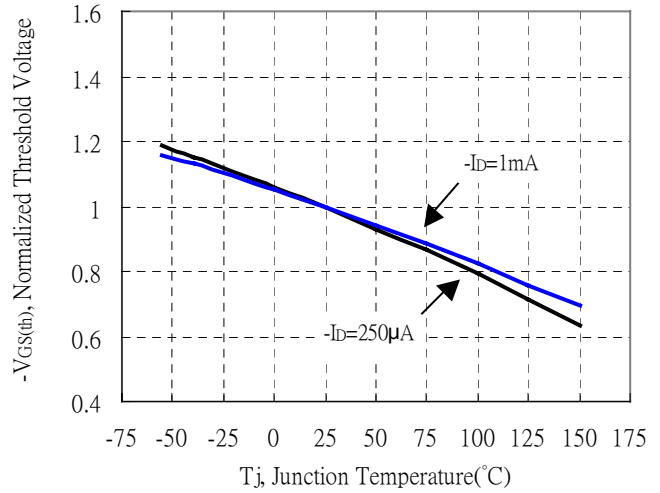

Forward Transfer Admittance vs Drain Current

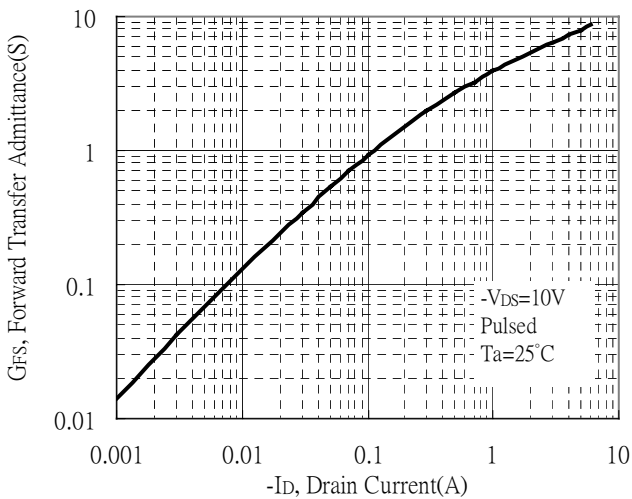

Gate Charge Characteristics

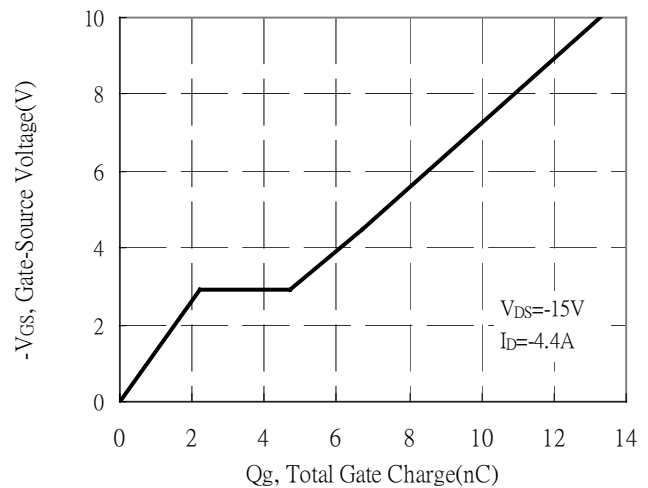

Maximum Safe Operating Area

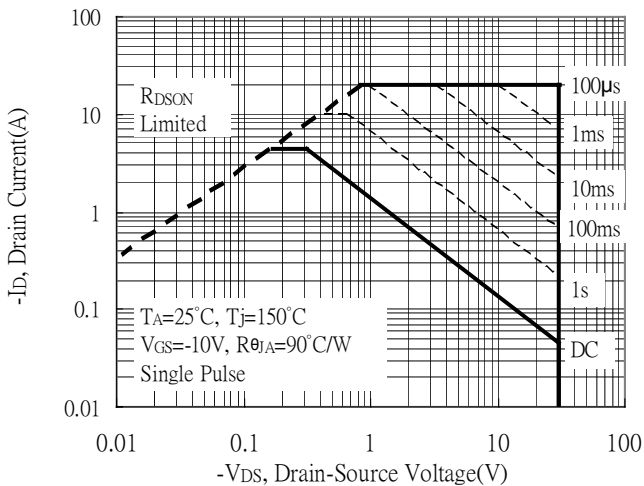

Maximum Drain Current vs Junction Temperature

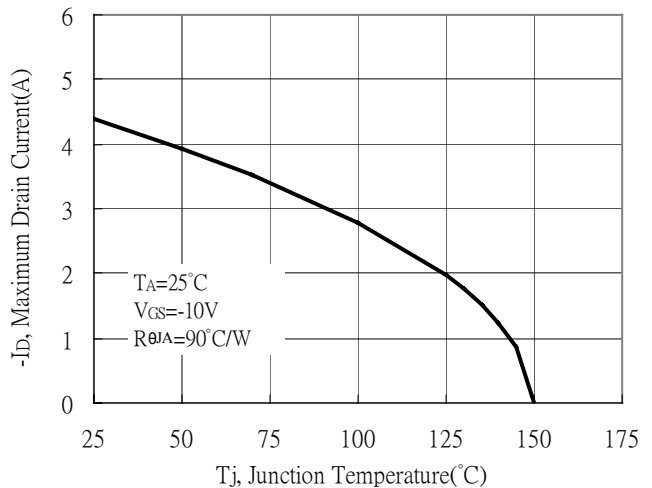

Typical Characteristics(Cont.) : Q2(P-channel)

Single Pulse Power Rating, Junction to Ambient
 (Note on page 2)

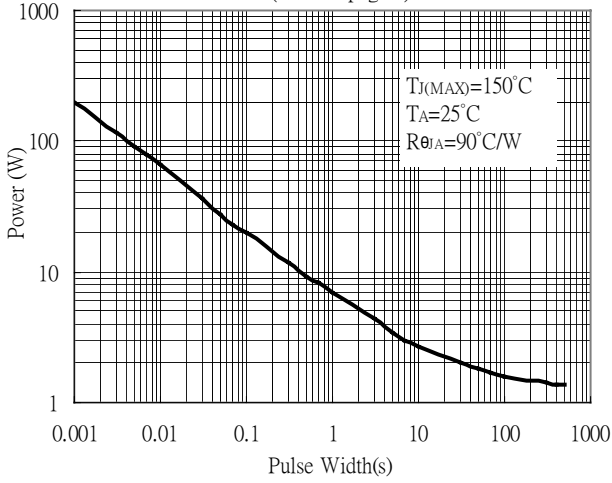

Typical Transfer Characteristics

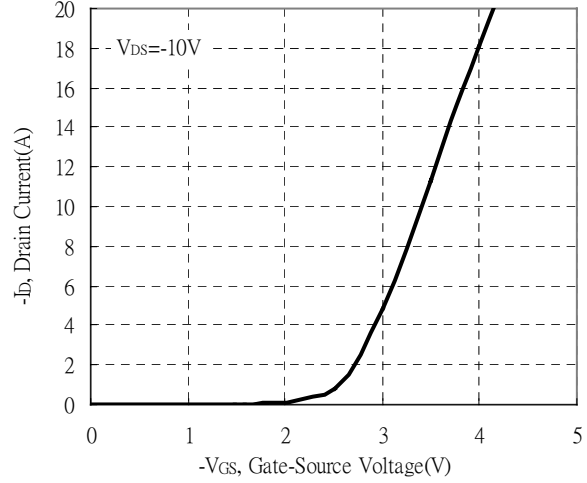

Transient Thermal Response Curves

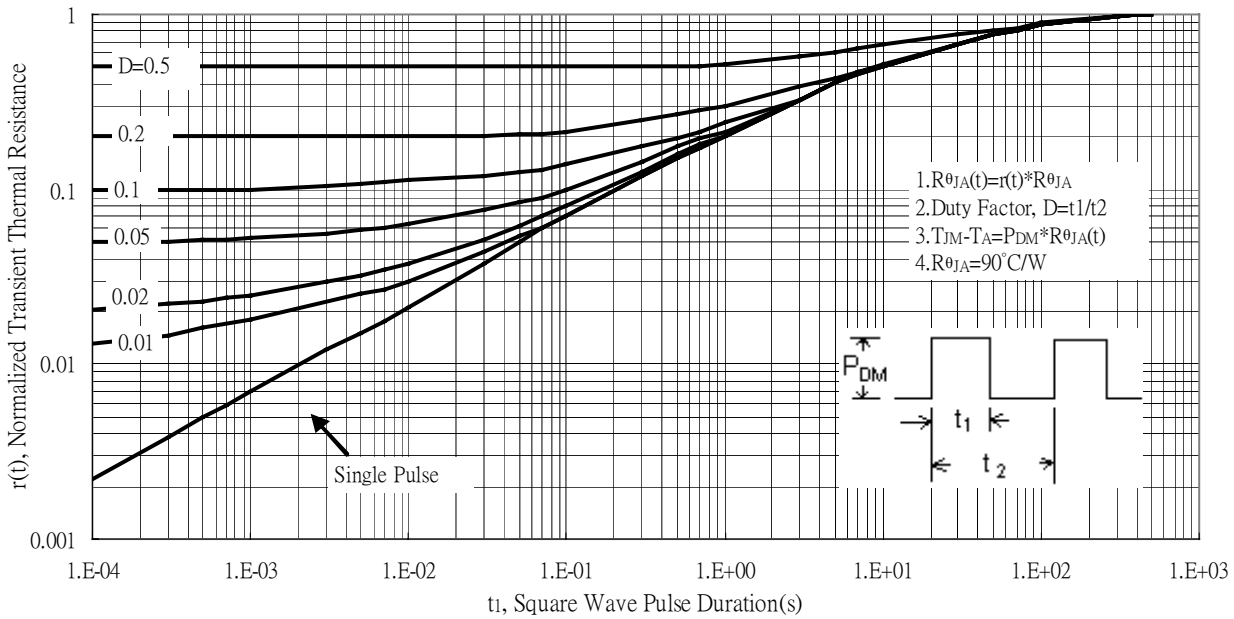

Reel Dimension

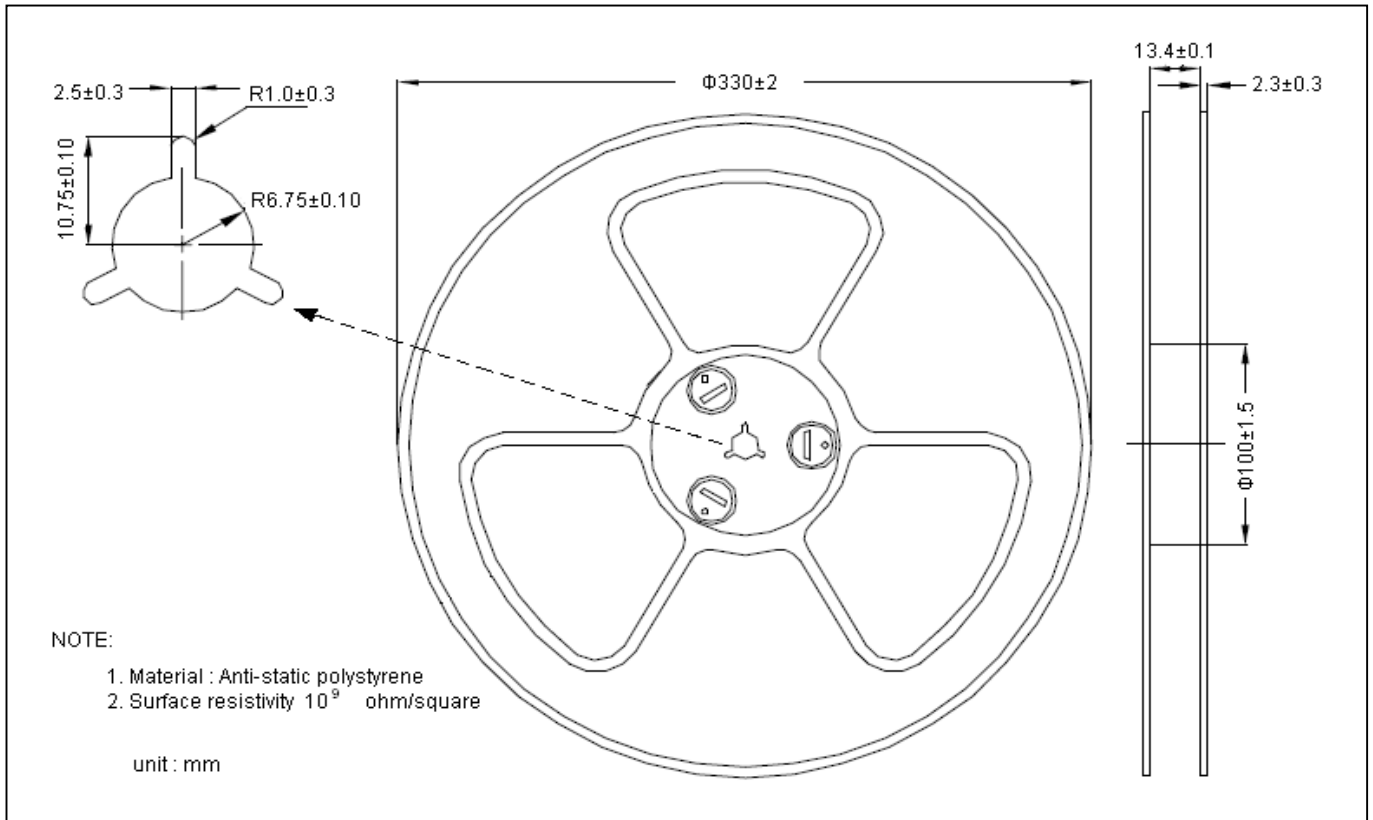

Carrier Tape Dimension

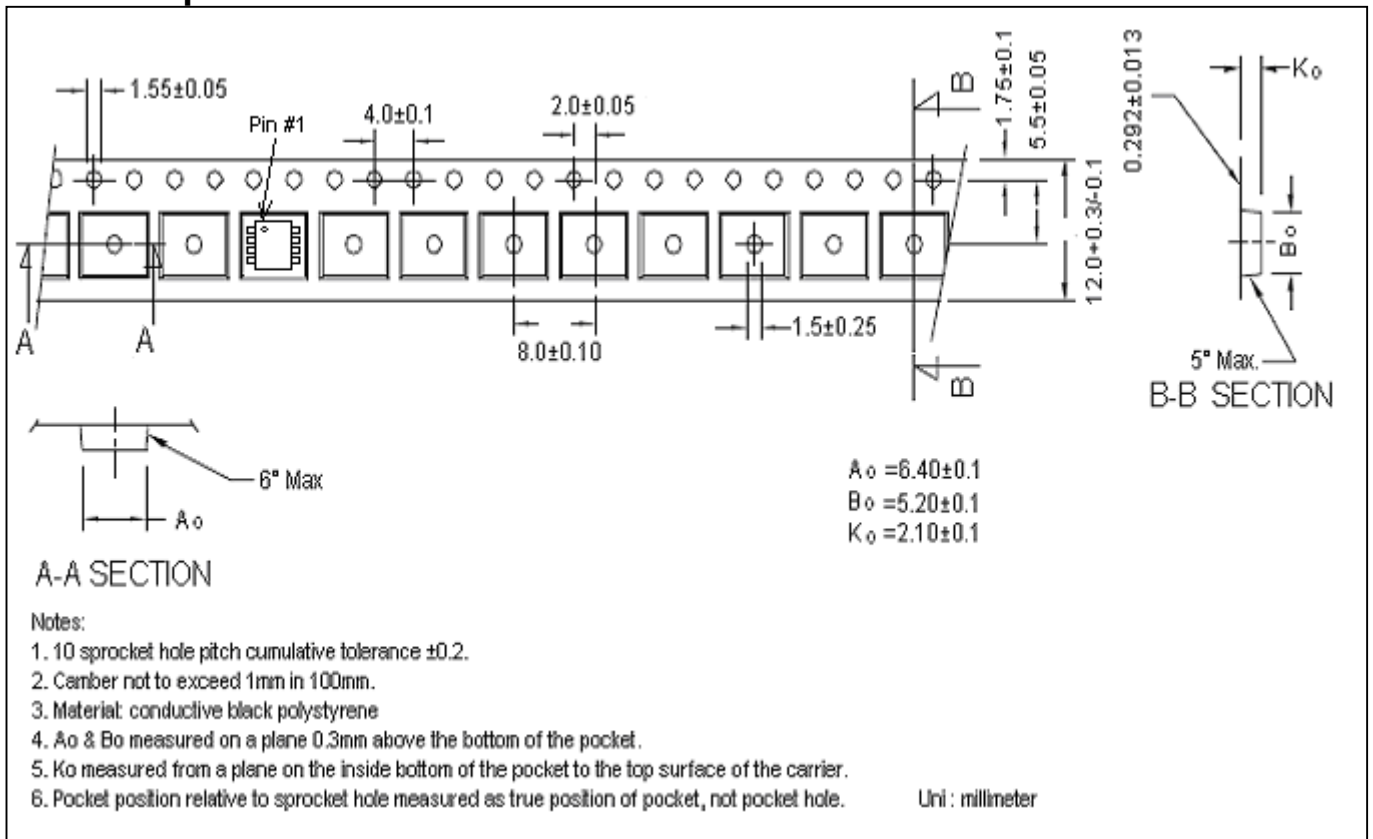

Recommended wave soldering condition

Product	Peak Temperature	Soldering Time
Pb-free devices	260 +0/-5 °C	5 +1/-1 seconds

Recommended temperature profile for IR reflow

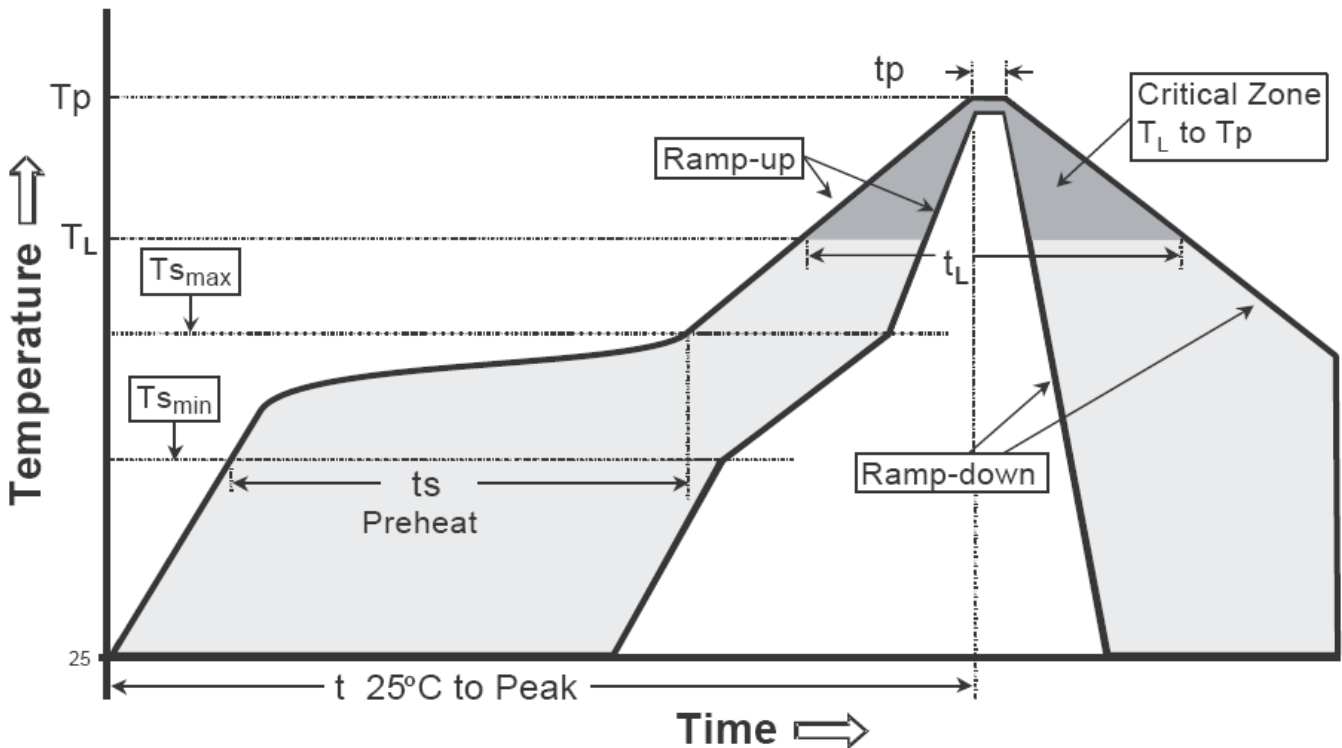

Profile feature	Sn-Pb eutectic Assembly	Pb-free Assembly
Average ramp-up rate (Tsmax to Tp)	3°C/second max.	3°C/second max.
Preheat		
-Temperature Min(Ts min)	100°C	150°C
-Temperature Max(Ts max)	150°C	200°C
-Time(ts min to ts max)	60-120 seconds	60-180 seconds
Time maintained above:		
-Temperature (Tl)	183°C	217°C
- Time (tl)	60-150 seconds	60-150 seconds
Peak Temperature(Tp)	240 +0/-5 °C	260 +0/-5 °C
Time within 5°C of actual peak temperature(tp)	10-30 seconds	20-40 seconds
Ramp down rate	6°C/second max.	6°C/second max.
Time 25 °C to peak temperature	6 minutes max.	8 minutes max.

Note : All temperatures refer to topside of the package, measured on the package body surface.

SOP-8 Dimension

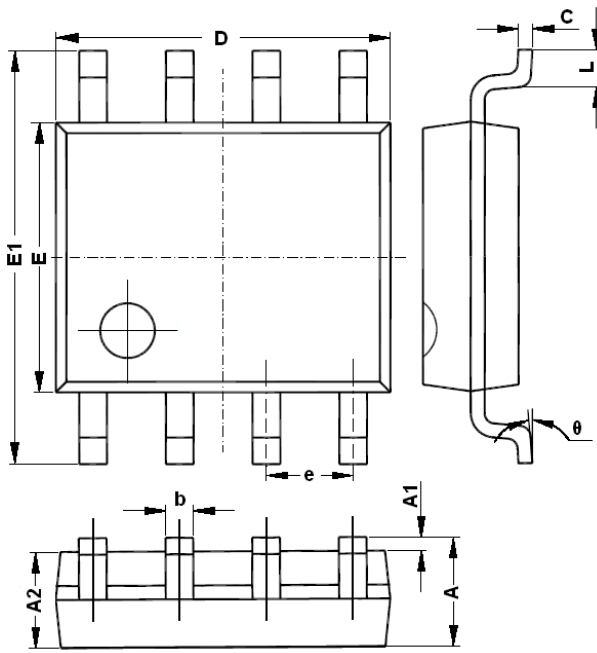

The diagram shows three views of the SOP-8 package: a top view with dimensions D, E, and E1; a side view with dimensions C, L, and θ ; and a bottom view with dimensions A, A1, A2, and b.

Marking:

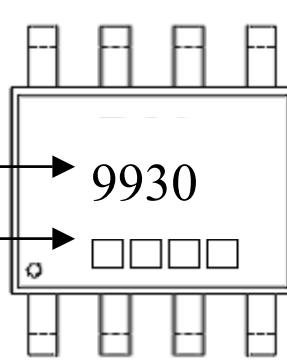

Device Name → **9930**

Date Code → □ □ □ □

Date Code(counting from left to right) :

1st code: year code, the last digit of Christian year

2nd code : month code, Jan→A, Feb→B, Mar→C, Apr→D
 May→E, Jun→F, Jul→G, Aug→H, Sep→J,
 Oct→K, Nov→L, Dec→M

3rd and 4th codes : production serial number, 01~99

8-Lead SOP-8 Plastic Package
 CYStek Package Code: Q8

DIM	Millimeters		Inches		DIM	Millimeters		Inches	
	Min.	Max.	Min.	Max.		Min.	Max.	Min.	Max.
A	1.350	1.750	0.053	0.069	E	3.800	4.000	0.150	0.157
A1	0.100	0.250	0.004	0.010	E1	5.800	6.200	0.228	0.244
A2	1.350	1.550	0.053	0.061	e	1.270	(BSC)	0.050	(BSC)
b	0.330	0.510	0.013	0.020	L	0.400	1.270	0.016	0.050
c	0.170	0.250	0.006	0.010	θ	0	8°	0	8°
D	4.700	5.100	0.185	0.200					

Notes: 1.Controlling dimension: millimeters.
 2.Maximum lead thickness includes lead finish thickness, and minimum lead thickness is the minimum thickness of base material.
 3.If there is any question with packing specification or packing method, please contact your local CYStek sales office.

Material:

- Lead: Pure tin plated.
- Mold Compound: Epoxy resin family, flammability solid burning class: UL94V-0.

Important Notice:

- All rights are reserved. Reproduction in whole or in part is prohibited without the prior written approval of CYStek.
- CYStek reserves the right to make changes to its products without notice.
- CYStek **semiconductor products are not warranted to be suitable for use in Life-Support Applications, or systems.**
- CYStek assumes no liability for any consequence of customer product design, infringement of patents, or application assistance.