

**N- AND P-Channel Logic Level Enhancement Mode MOSFET**

# MTBA5C10Q8

	N-CH	P-CH
BV <sub>DSS</sub>	100V	-100V
I <sub>D</sub>	3A	-2.5A
R <sub>DS(on)(MAX.)</sub>	150mΩ	250mΩ

**Description**

The MTBA5C10Q8 consists of a N-channel and a P-channel enhancement-mode MOSFET in a single SOP-8 package, providing the designer with the best combination of fast switching, ruggedized device design, low on-resistance and cost-effectiveness.

The SOP-8 package is universally preferred for all commercial-industrial surface mount applications.

**Features**

- Simple drive requirement
- Low on-resistance
- Fast switching speed
- Pb-free lead plating and halogen-free package

**Equivalent Circuit**

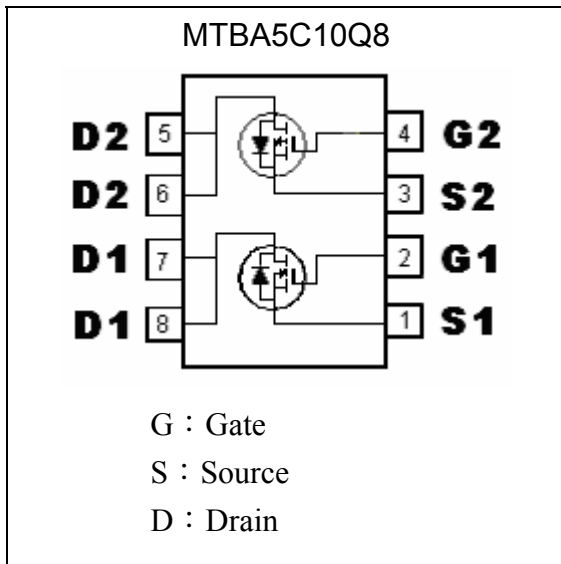

**Outline**

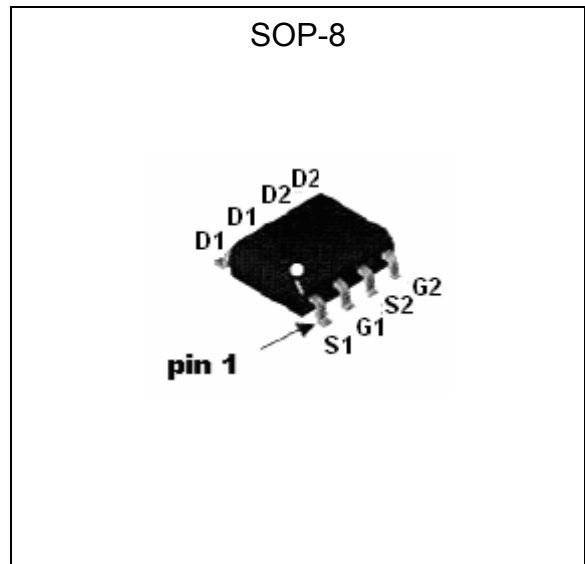



**Absolute Maximum Ratings** (T<sub>C</sub>=25°C, unless otherwise noted)

Parameter	Symbol	Limits		Unit
		N-channel	P-channel	
Drain-Source Breakdown Voltage	BV <sub>DSS</sub>	100	-100	V
Gate-Source Voltage	V <sub>GS</sub>	±20	±20	V
Continuous Drain Current @T <sub>C</sub> =25 °C	I <sub>D</sub>	3	-2.5	A
Continuous Drain Current @T <sub>C</sub> =100 °C	I <sub>D</sub>	2.1	-1.8	A
Pulsed Drain Current (Note 1)	I <sub>DM</sub>	12	-10	A
Power Dissipation @T <sub>A</sub> =25°C	P <sub>D</sub>	2.4		W
Power Dissipation @T <sub>A</sub> =100°C		1.3		
Operating Junction and Storage Temperature Range	T <sub>j</sub> ; T <sub>stg</sub>	-55~+175		°C
Thermal Resistance, Junction-to-Case	R <sub>θJC</sub>	25		°C/W
Thermal Resistance, Junction-to-Ambient (Note 2)	R <sub>θJA</sub>	62.5		°C/W

Note : 1.Pulse width limited by maximum junction temperature.  
 2.Surface mounted on 1 in<sup>2</sup> copper pad of FR-4 board, 135°C/W when mounted on minimum copper pad.

**N-Channel Electrical Characteristics** (T<sub>C</sub>=25°C, unless otherwise specified)

Symbol	Min.	Typ.	Max.	Unit	Test Conditions
<b>Static</b>					
BV <sub>DSS</sub>	100	-	-	V	V <sub>GS</sub> =0, I <sub>D</sub> =250μA
V <sub>GS(th)</sub>	1.0	-	3.0	V	V <sub>DS</sub> =V <sub>GS</sub> , I <sub>D</sub> =250μA
I <sub>GSS</sub>	-	-	±100	nA	V <sub>GS</sub> =±20V, V <sub>DS</sub> =0
I <sub>DSS</sub>	-	-	1	μA	V <sub>DS</sub> =80V, V <sub>GS</sub> =0
	-	-	25	μA	V <sub>DS</sub> =70V, V <sub>GS</sub> =0, T <sub>j</sub> =125°C
*I <sub>D(ON)</sub>	12	-	-	A	V <sub>GS</sub> =10V, V <sub>DS</sub> =5V
*R <sub>DS(ON)</sub>	-	125	150	mΩ	I <sub>D</sub> =2.5A, V <sub>GS</sub> =10V
	-	168	225		I <sub>D</sub> =2A, V <sub>GS</sub> =5V
*G <sub>FS</sub>	-	8	-	S	V <sub>DS</sub> =5V, I <sub>D</sub> =2.5A
<b>Dynamic</b>					
C <sub>iss</sub>	-	740	-	pF	V <sub>DS</sub> =20V, V <sub>GS</sub> =0, f=1MHz
C <sub>oss</sub>	-	62	-		
C <sub>rss</sub>	-	50	-		
*t <sub>d(ON)</sub>	-	15	-	ns	V <sub>DS</sub> =50V, I <sub>D</sub> =1A, V <sub>GS</sub> =10V, R <sub>G</sub> =6Ω
*t <sub>r</sub>	-	35	-		
*t <sub>d(OFF)</sub>	-	25	-		
*t <sub>f</sub>	-	25	-		
*Q <sub>g</sub>	-	18.8	-	nC	V <sub>DS</sub> =80V, I <sub>D</sub> =2.5A, V <sub>GS</sub> =10V
*Q <sub>gs</sub>	-	3.8	-		
*Q <sub>gd</sub>	-	4.5	-		
<b>Body Diode</b>					
*V <sub>F(S-D)</sub>	-	-	1.3	V	V <sub>GS</sub> =0V, I <sub>F</sub> =3A
*I <sub>S</sub>	-	3	-	A	
*I <sub>SM</sub>	-	12	-		

\*Pulse Test : Pulse Width ≤300μs, Duty Cycle≤2%



**P-Channel Electrical Characteristics (Tc=25°C, unless otherwise specified)**

Symbol	Min.	Typ.	Max.	Unit	Test Conditions
<b>Static</b>					
BV <sub>DSS</sub>	-100	-	-	V	V <sub>GS</sub> =0, I <sub>D</sub> =-250μA
V <sub>GS(th)</sub>	-1.0	-	-3.0		V <sub>DS</sub> =V <sub>GS</sub> , I <sub>D</sub> =-250μA
I <sub>GSS</sub>	-	-	±100	nA	V <sub>GS</sub> =±20V, V <sub>DS</sub> =0
I <sub>DSS</sub>	-	-	-1	μA	V <sub>DS</sub> =-80V, V <sub>GS</sub> =0
	-	-	-25		V <sub>DS</sub> =-70V, V <sub>GS</sub> =0, T <sub>j</sub> =125°C
I <sub>D(ON)</sub>	-10	-	-	A	V <sub>GS</sub> =-10V, V <sub>DS</sub> =-5V
*R <sub>DS(ON)</sub>	-	210	250	mΩ	I <sub>D</sub> =-1.5A, V <sub>GS</sub> =-10V
	-	280	375		I <sub>D</sub> =-1A, V <sub>GS</sub> =-5V
*G <sub>FS</sub>	-	7	-	S	V <sub>DS</sub> =-5V, I <sub>D</sub> =-1.5A
<b>Dynamic</b>					
C <sub>iss</sub>	-	1066	-	pF	V <sub>DS</sub> =-20V, V <sub>GS</sub> =0, f=1MHz
C <sub>oss</sub>	-	365	-		
C <sub>rss</sub>	-	55	-		
*t <sub>d(ON)</sub>	-	12	-	ns	V <sub>DS</sub> =-50V, I <sub>D</sub> =-1A, V <sub>GS</sub> =-10V, R <sub>G</sub> =6Ω
*t <sub>r</sub>	-	55	-		
*t <sub>d(OFF)</sub>	-	40	-		
*t <sub>f</sub>	-	40	-		
*Q <sub>g</sub>	-	31	-	nC	V <sub>DS</sub> =-80V, I <sub>D</sub> =-1.5A, V <sub>GS</sub> =-10V
*Q <sub>gs</sub>	-	6.3	-		
*Q <sub>gd</sub>	-	4.5	-		
<b>Body Diode</b>					
*V <sub>F(S-D)</sub>	-	-	1.3	V	V <sub>GS</sub> =0V, I <sub>F</sub> =2.5A
*I <sub>S</sub>	-	-	-2.5	A	
*I <sub>SM</sub>	-	-	-10		

\*Pulse Test : Pulse Width ≤300μs, Duty Cycle≤2%

**Ordering Information**

Device	Package	Shipping	Marking
MTBA5C10Q8	SOP-8 (Pb-free lead plating & halogen-free package)	2500 pcs / Tape & Reel	BA5C10



### N-channel Characteristic Curves

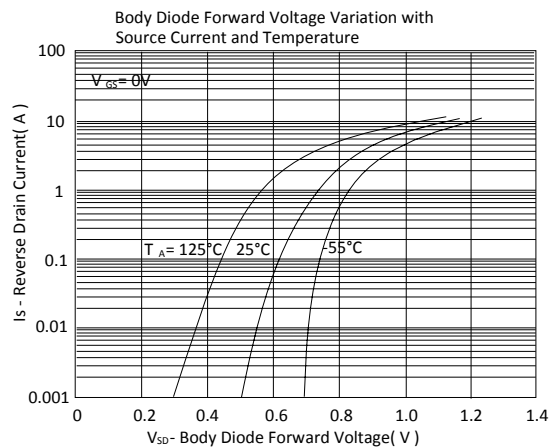
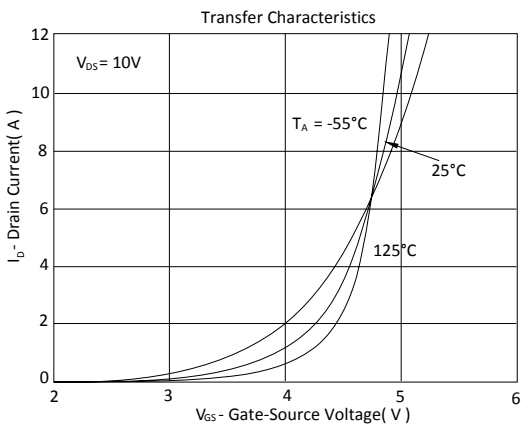
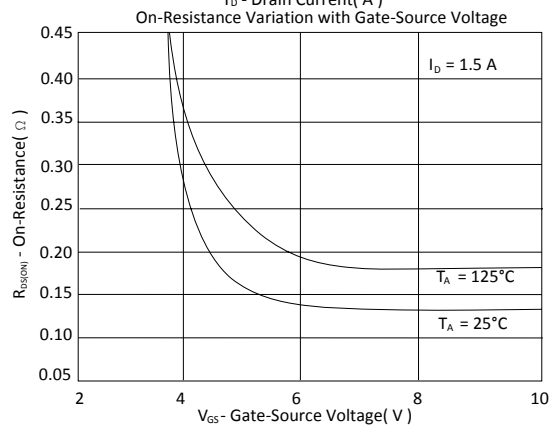
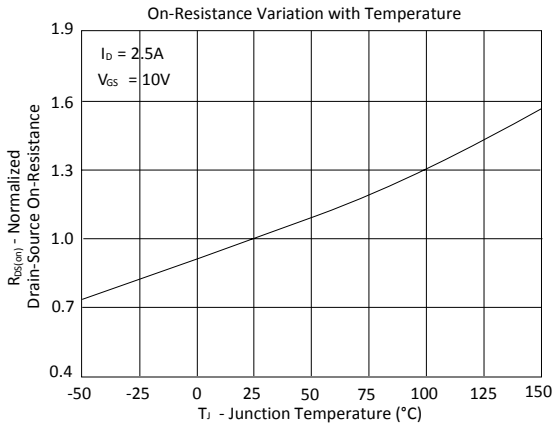
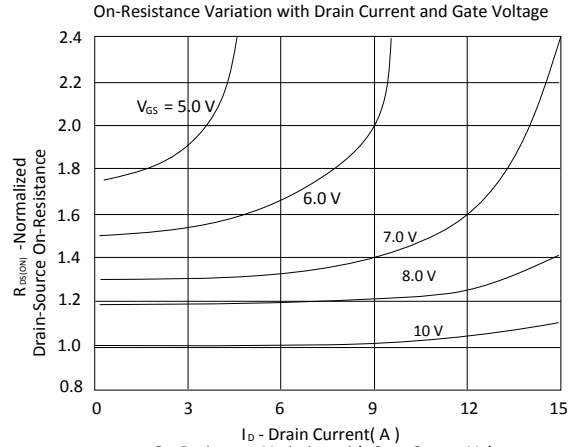
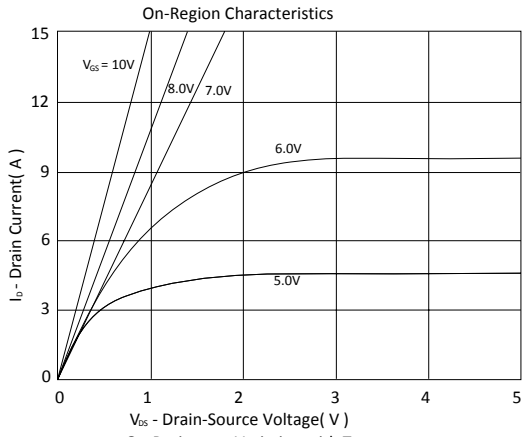



N-channel Characteristic Curves(Cont.)

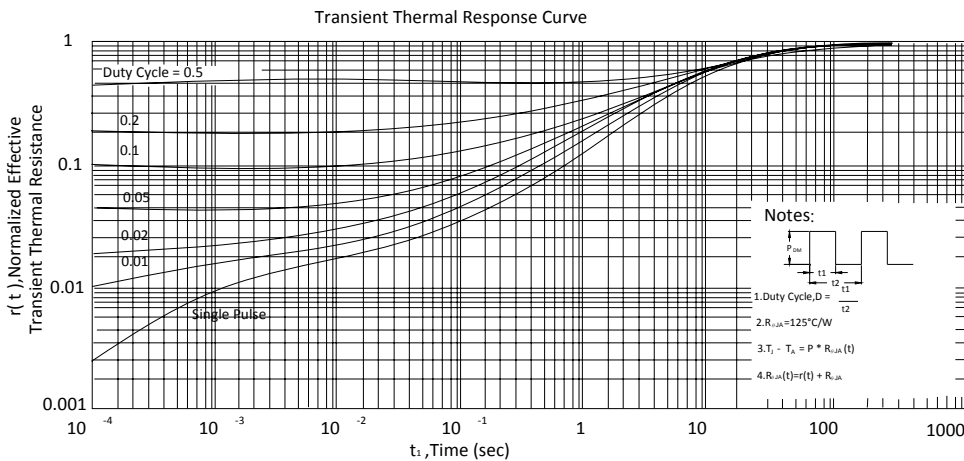
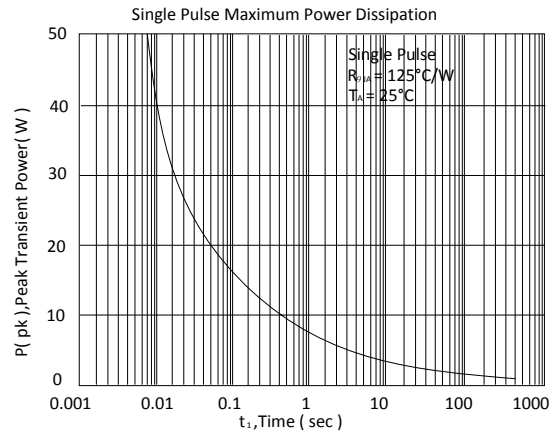
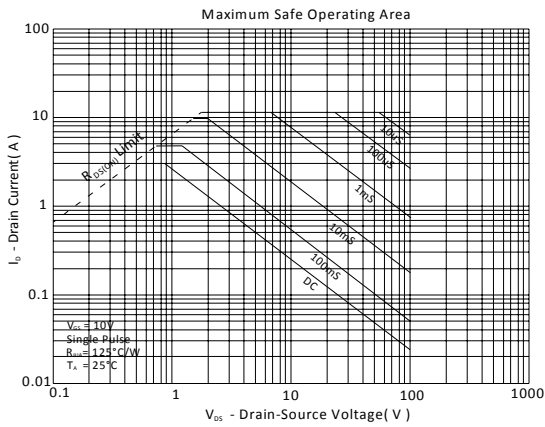
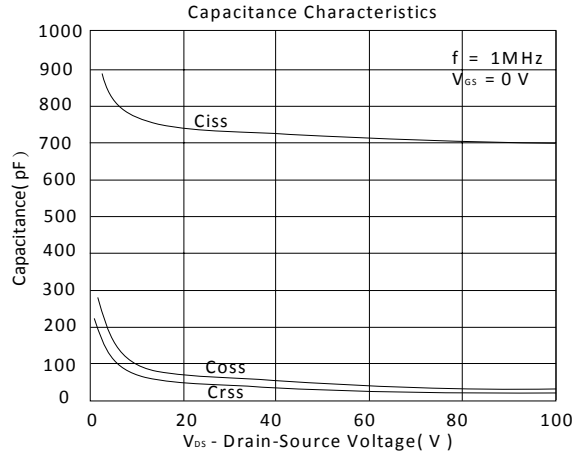
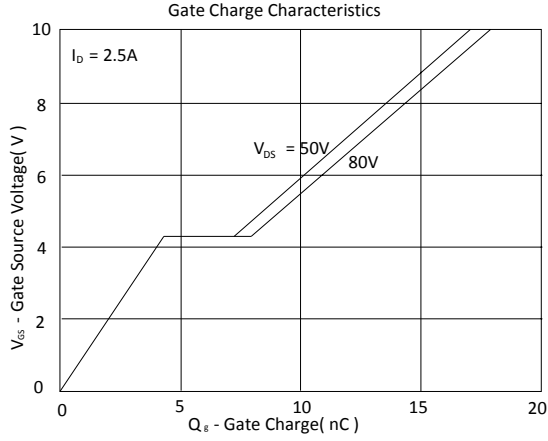



### P-channel Characteristic Curves

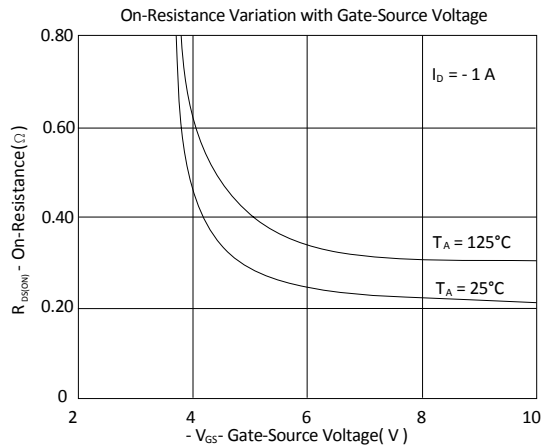
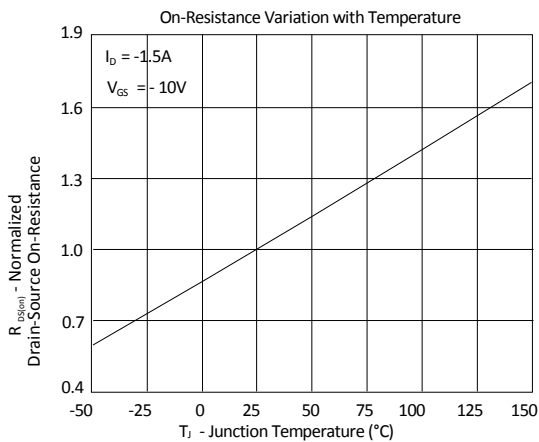
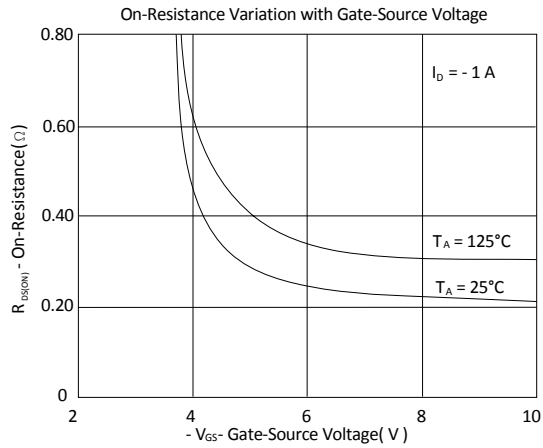
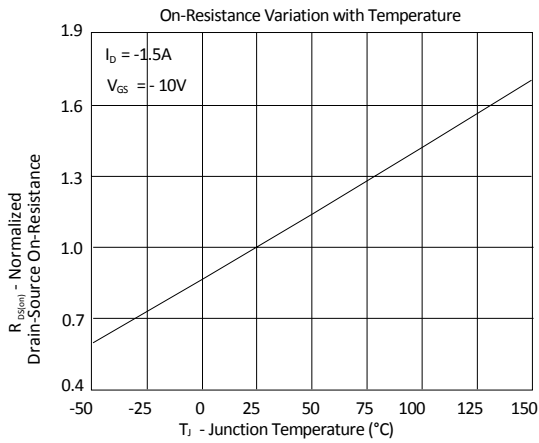
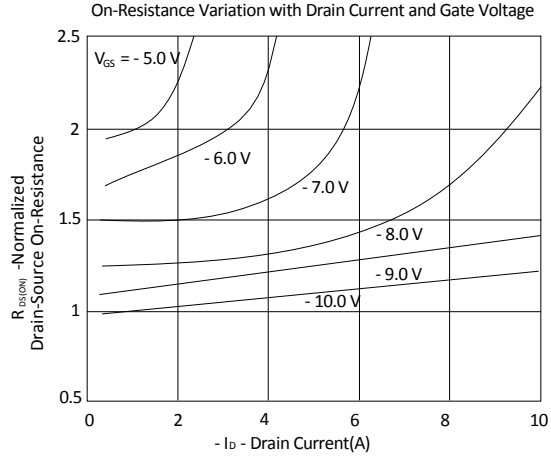
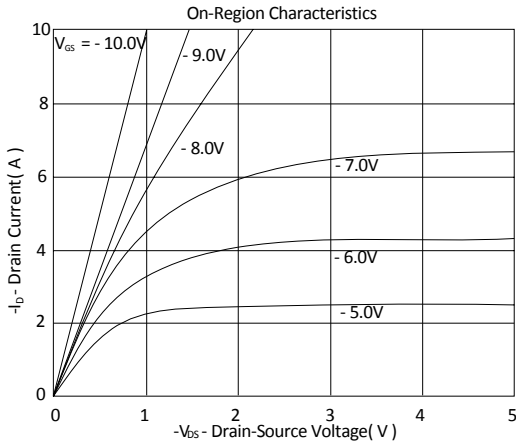



P-channel Characteristic Curves(Cont.)

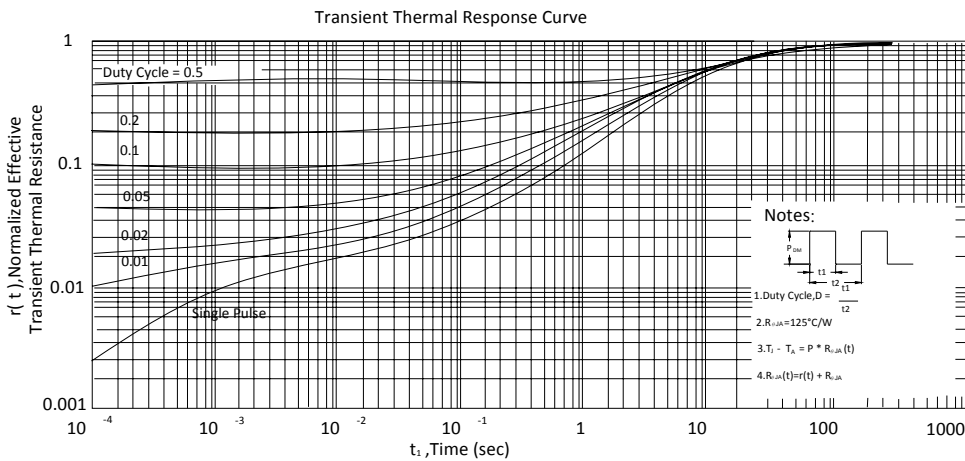
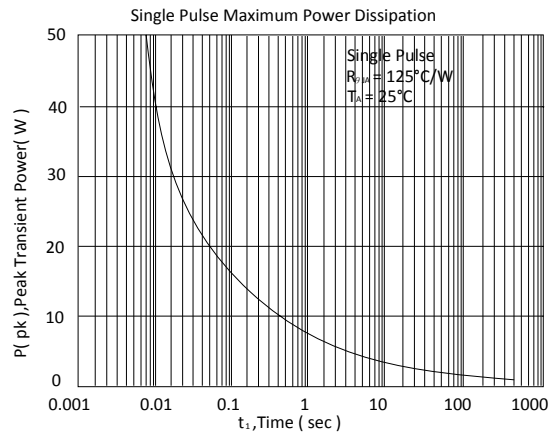
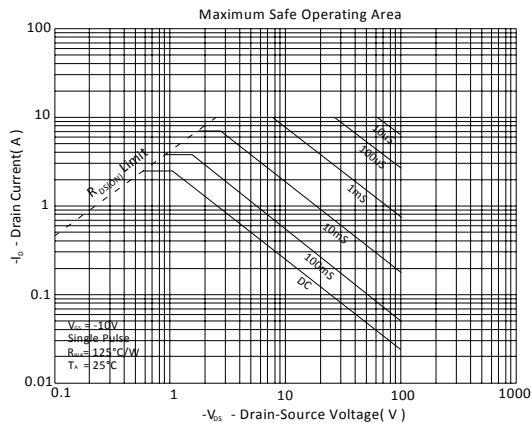
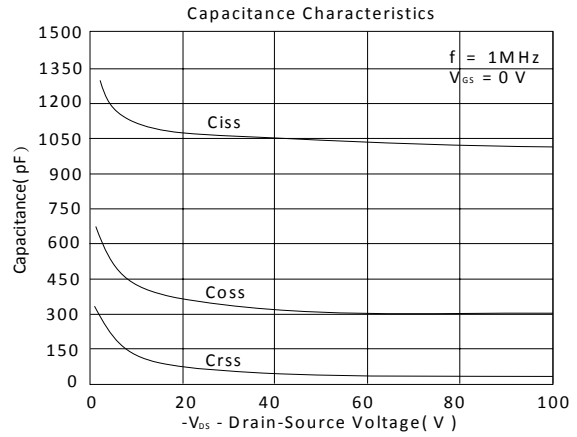
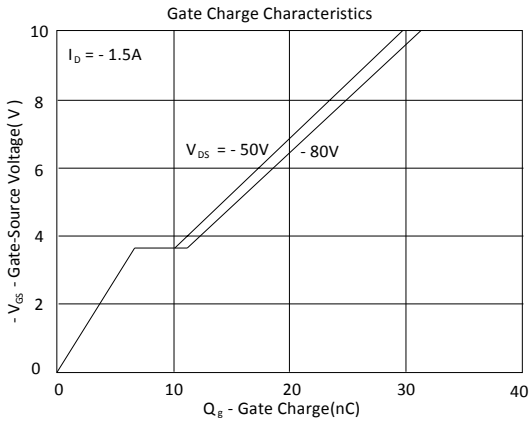

**Reel Dimension**

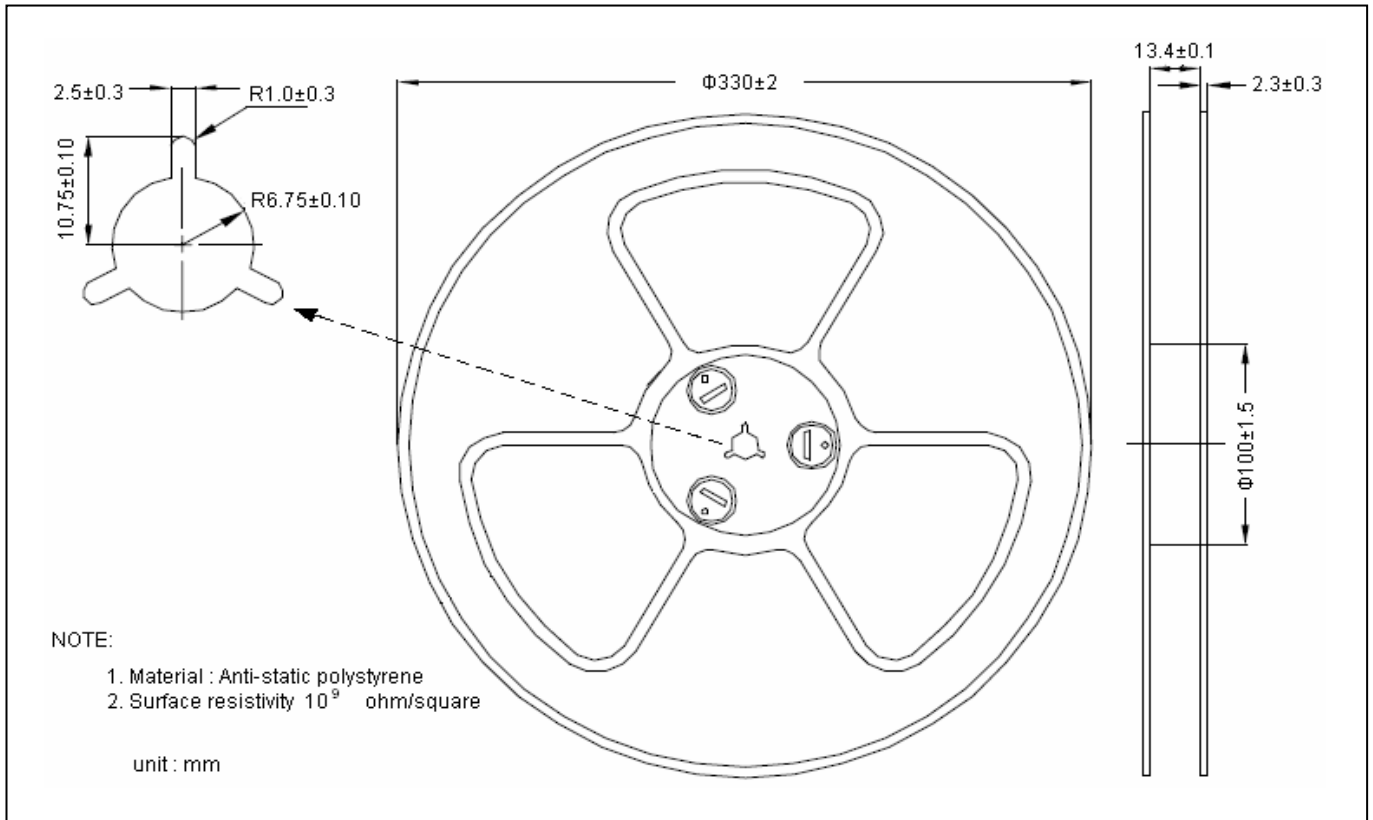

**Carrier Tape Dimension**

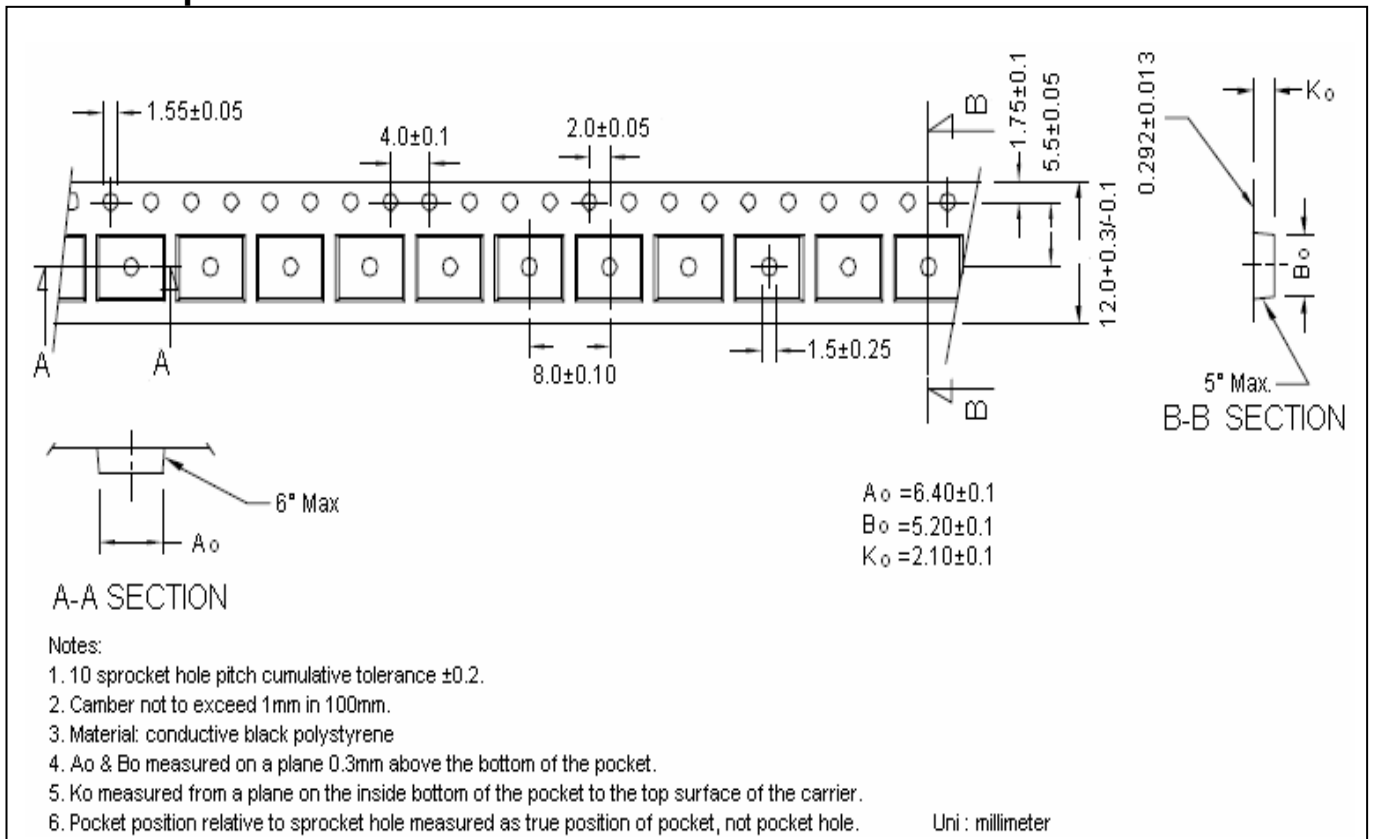



**Recommended wave soldering condition**

Product	Peak Temperature	Soldering Time
Pb-free devices	260 +0/-5 °C	5 +1/-1 seconds

**Recommended temperature profile for IR reflow**

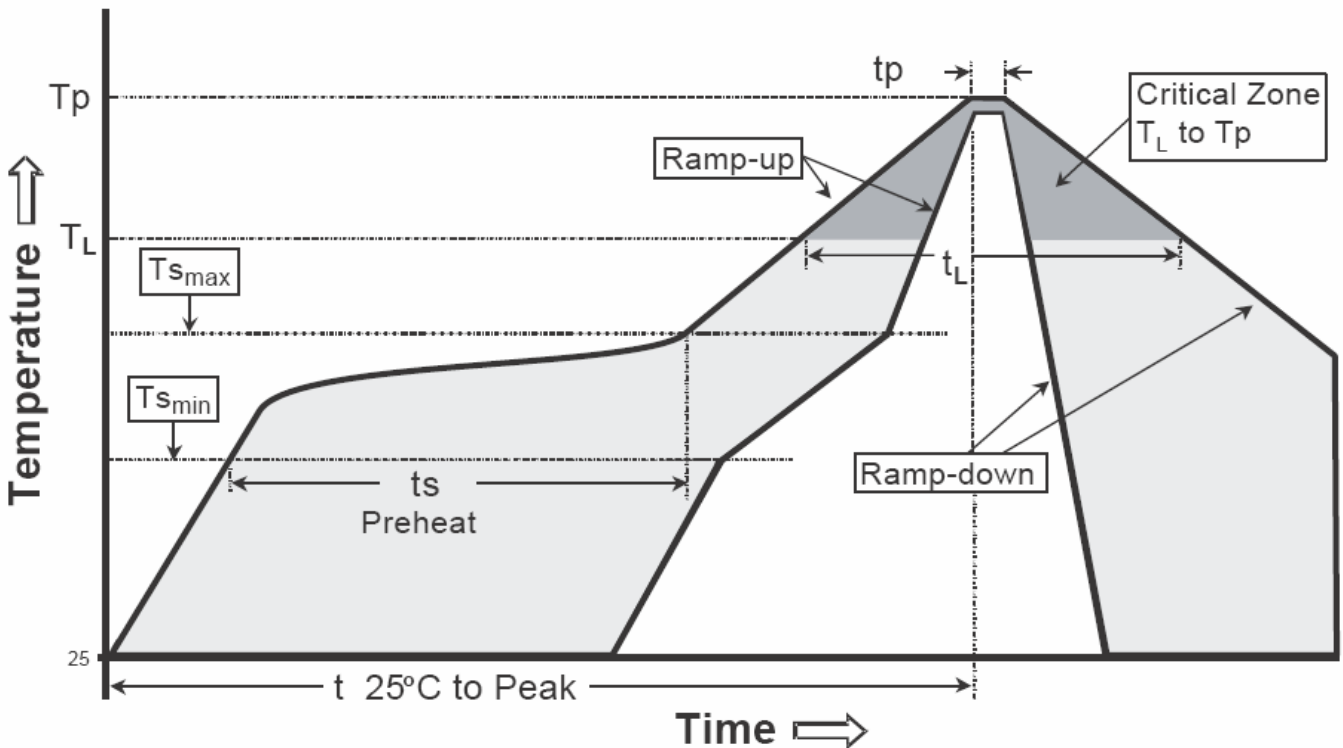

Profile feature	Sn-Pb eutectic Assembly	Pb-free Assembly
Average ramp-up rate (Tsmax to Tp)	3°C/second max.	3°C/second max.
Preheat		
-Temperature Min(Ts min)	100°C	150°C
-Temperature Max(Ts max)	150°C	200°C
-Time(ts min to ts max)	60-120 seconds	60-180 seconds
Time maintained above:		
-Temperature (TL)	183°C	217°C
- Time (tL)	60-150 seconds	60-150 seconds
Peak Temperature(TP)	240 +0/-5 °C	260 +0/-5 °C
Time within 5°C of actual peak temperature(tp)	10-30 seconds	20-40 seconds
Ramp down rate	6°C/second max.	6°C/second max.
Time 25 °C to peak temperature	6 minutes max.	8 minutes max.

Note : All temperatures refer to topside of the package, measured on the package body surface.

**SOP-8 Dimension**

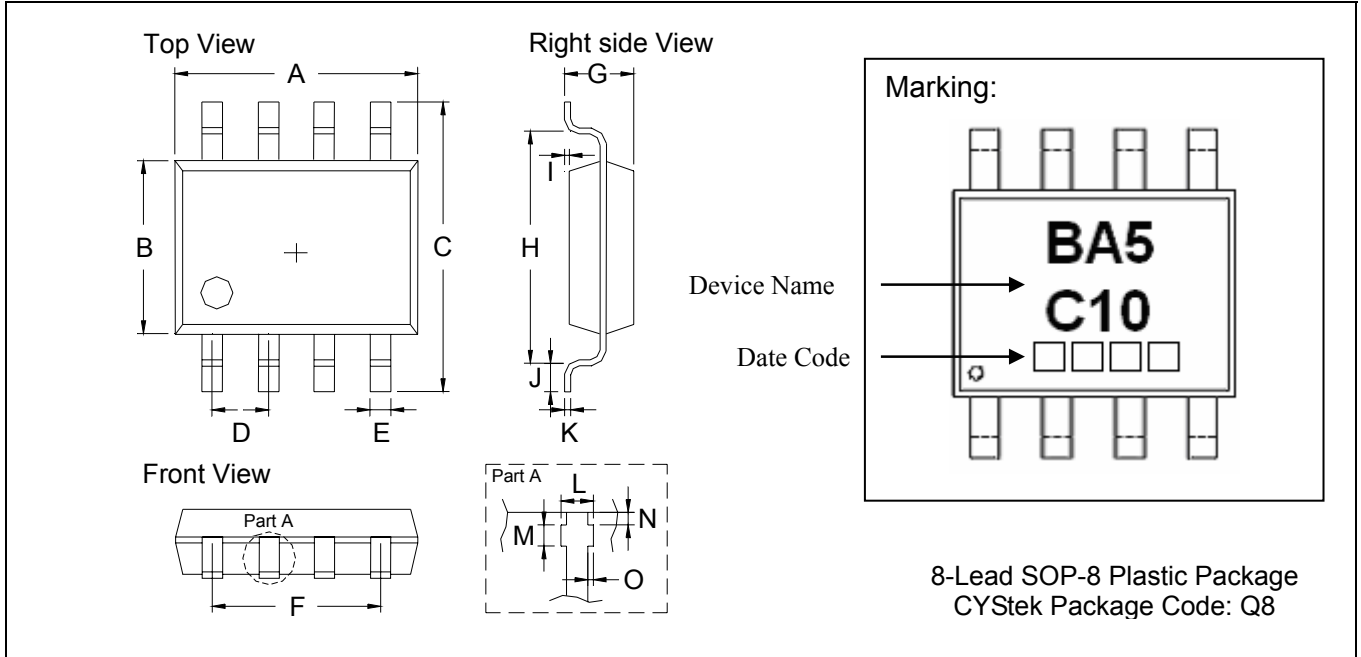

\*: Typical

DIM	Inches		Millimeters		DIM	Inches		Millimeters	
	Min.	Max.	Min.	Max.		Min.	Max.	Min.	Max.
A	0.1909	0.2007	4.85	5.10	I	0.0019	0.0078	0.05	0.20
B	0.1515	0.1555	3.85	3.95	J	0.0118	0.0275	0.30	0.70
C	0.2283	0.2441	5.80	6.20	K	0.0074	0.0098	0.19	0.25
D	0.0480	0.0519	1.22	1.32	L	0.0145	0.0204	0.37	0.52
E	0.0145	0.0185	0.37	0.47	M	0.0118	0.0197	0.30	0.50
F	0.1472	0.1527	3.74	3.88	N	0.0031	0.0051	0.08	0.13
G	0.0570	0.0649	1.45	1.65	O	0.0000	0.0059	0.00	0.15
H	0.1889	0.2007	4.80	5.10					

**Notes:** 1.Controlling dimension: millimeters.  
 2.Maximum lead thickness includes lead finish thickness, and minimum lead thickness is the minimum thickness of base material.  
 3.If there is any question with packing specification or packing method, please contact your local CYStek sales office.

**Material:**

- Lead: Pure tin plated.
- Mold Compound: Epoxy resin family, flammability solid burning class: UL94V-0.

**Important Notice:**

- All rights are reserved. Reproduction in whole or in part is prohibited without the prior written approval of CYStek.
- CYStek reserves the right to make changes to its products without notice.
- CYStek **semiconductor products are not warranted to be suitable for use in Life-Support Applications, or systems.**
- CYStek assumes no liability for any consequence of customer product design, infringement of patents, or application assistance.