

N-Channel Logic Level Enhancement Mode Power MOSFET

MTB4D0N03BJ3

BV_{DSS}		30V
$I_D @ V_{GS}=10V, T_A=25^\circ C$		15A
$I_D @ V_{GS}=10V, T_C=25^\circ C$		56A
$R_{DS(on)(TYP)}$	$V_{GS}=10V, I_D=20A$	3.9m Ω
	$V_{GS}=4.5V, I_D=10A$	5.0m Ω

Features

- Single Drive Requirement
- Low On-resistance
- Fast Switching Characteristic
- Repetitive Avalanche Rated
- Pb-free lead plating and halogen-free package

Equivalent Circuit

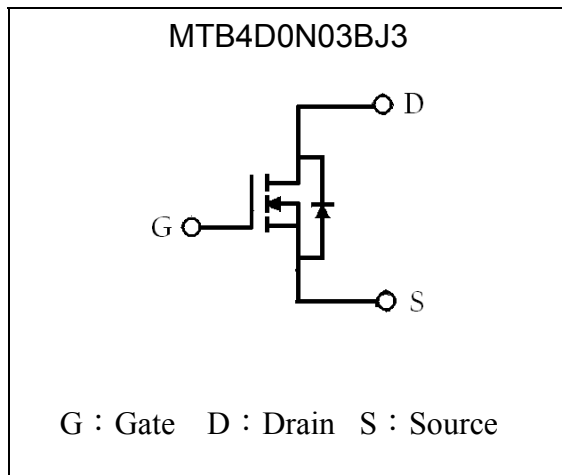

Outline

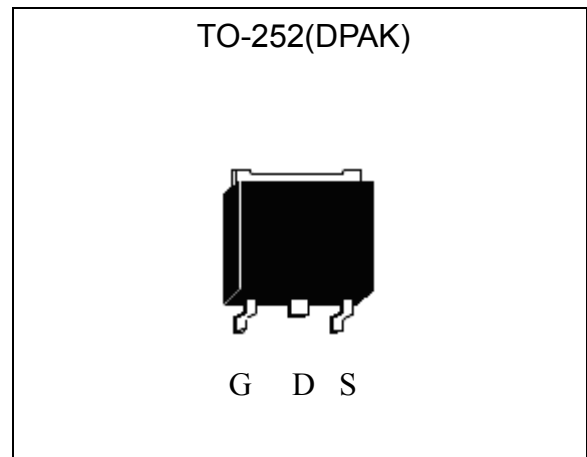

Ordering Information

Device	Package	Shipping
MTB4D0N03BJ3-0-T3-G	TO-252 (Pb-free lead plating and halogen-free package)	2500 pcs / tape& reel

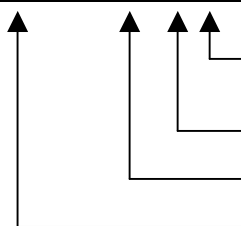

Environment friendly grade : S for RoHS compliant products, G for RoHS compliant and green compound products

Packing spec, T3 : 2500 pcs / tape & reel, 13" reel

Product rank, zero for no rank products

Product name



Absolute Maximum Ratings (Ta=25°C, unless otherwise specified)

Parameter	Symbol	Limits	Unit	
Drain-Source Voltage	V _{DS}	30	V	
Gate-Source Voltage	V _{GS}	±20		
Continuous Drain Current @ V _{GS} =10V, T _C =25°C	I _D	56	A	
Continuous Drain Current @ V _{GS} =10V, T _C =100°C		35		
Continuous Drain Current @ V _{GS} =10V, T _A =25°C		15		
Continuous Drain Current @ V _{GS} =10V, T _A =70°C		12		
Pulsed Drain Current	I _{DM}	224 *1		
Avalanche Energy @ L=0.1mH, I _D =37A, R _G =25 Ω	E _{AS}	68 *3	mJ	
Repetitive Avalanche Energy @ L=0.05mH	E _{AR}	4.9		
Total Power Dissipation	P _D	T _C =25°C	36	W
		T _C =100°C	14.4	
	P _{DSM}	T _A =25°C	2.5 *2	
		T _A =70°C	1.6 *2	
Operating Junction and Storage Temperature Range	T _j , T _{stg}	-55~+150	°C	

Thermal Data

Parameter	Symbol	Value	Unit
Thermal Resistance, Junction-to-case, max	R _{th,j-c}	3.5	°C/W
Thermal Resistance, Junction-to-ambient, max	R _{th,j-a}	50 *2	

- Note : 1. Pulse width limited by maximum junction temperature.
 2. Surface mounted on a 1 in² pad of 2oz copper. In practice R_{th,j-a} will be determined by customer's PCB characteristics. 125°C/W when mounted on a minimum pad of 2 oz. copper.
 3. 100% tested by conditions of L=0.6mH, I_{AS}=16A, V_{GS}=10V, V_{DD}=15V, rated 30V

Characteristics (T_C=25°C, unless otherwise specified)

Symbol	Min.	Typ.	Max.	Unit	Test Conditions
Static					
BV _{DSS}	30	-	-	V	V _{GS} =0V, I _D =250μA
V _{GS(th)}	1	-	2.5		V _{DS} = V _{GS} , I _D =250μA
G _{FS} *1	-	25	-	S	V _{DS} =5V, I _D =15A
I _{GSS}	-	-	±100	nA	V _{GS} =±20V
I _{DSS}	-	-	1	μA	V _{DS} =24V, V _{GS} =0V
	-	-	10		V _{DS} =24V, V _{GS} =0V, T _j =85°C
R _{DS(ON)} *1	-	3.9	5.0	mΩ	V _{GS} =10V, I _D =20A
	-	5.0	6.5		V _{GS} =4.5V, I _D =10A
Dynamic					
C _{iss}	-	1442	-	pF	V _{DS} =15V, V _{GS} =0V, f=1MHz
C _{oss}	-	270	-		
C _{rss}	-	182	-		
Q _g *1, 2	-	31.5	-	nC	V _{DS} =15V, V _{GS} =10V, I _D =15A
Q _{gs} *1, 2	-	3.6	-		
Q _{gd} *1, 2	-	8.7	-		

Characteristics (Tc=25°C, unless otherwise specified)

Symbol	Min.	Typ.	Max.	Unit	Test Conditions
t _{d(ON)} *1, 2	-	13	-	ns	V _{DS} =15V, I _D =15A, V _{GS} =10V, R _{GS} =3 Ω
t _r *1, 2	-	18	-		
t _{d(OFF)} *1, 2	-	43.8	-		
t _f *1, 2	-	10.6	-		
R _g	-	2.2	-	Ω	f=1MHz

Source-Drain Diode

I _S *1	-	-	56	A	
I _{SM} *3	-	-	224		
V _{SD} *1	-	0.84	1.2	V	I _S =20A, V _{GS} =0V
t _{rr}	-	12	-	ns	I _F =20A, dI _F /dt=100A/μs
Q _{rr}	-	4	-	nC	

Note : *1.Pulse Test : Pulse Width ≤300μs, Duty Cycle≤2%
 *2.Independent of operating temperature
 *3.Pulse width limited by maximum junction temperature.

Recommended soldering footprint

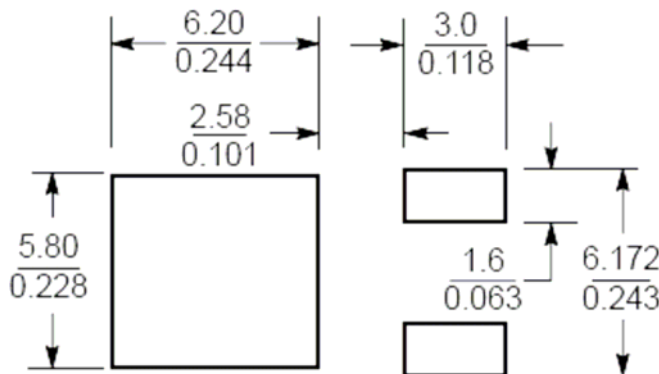

Unit ($\frac{\text{mm}}{\text{inch}}$)



Typical Characteristics

Typical Output Characteristics

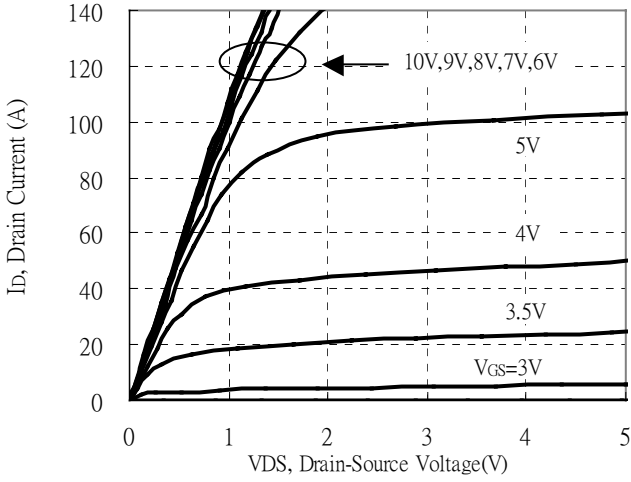

Breakdown Voltage vs Junction Temperature

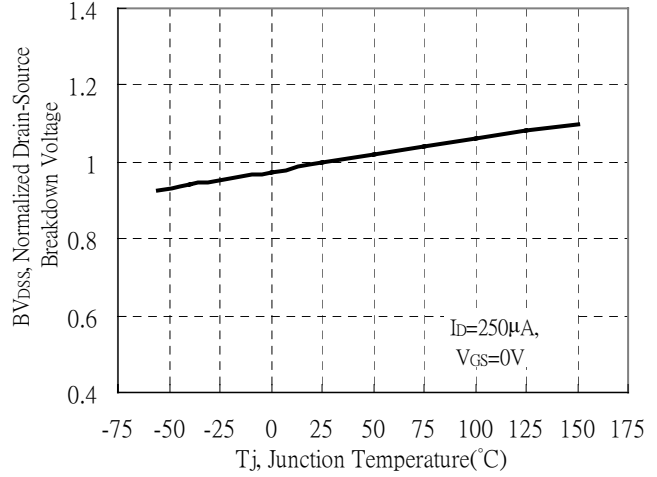

Static Drain-Source On-State resistance vs Drain Current

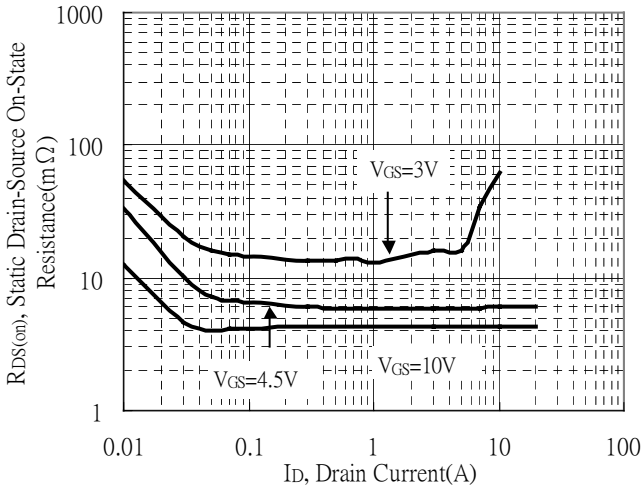

Reverse Drain Current vs Source-Drain Voltage

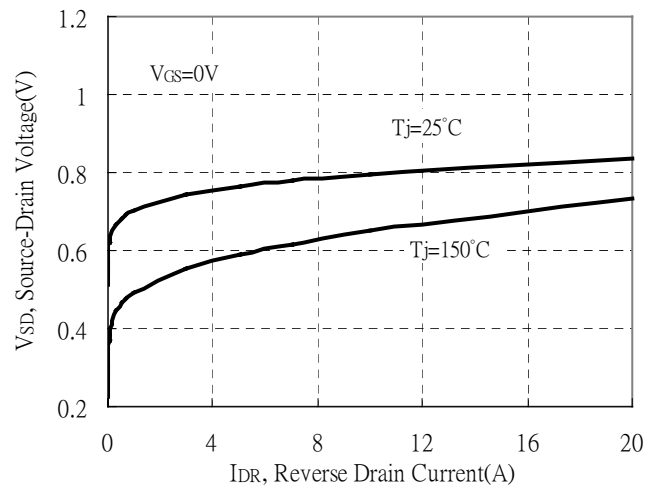

Static Drain-Source On-State Resistance vs Gate-Source Voltage

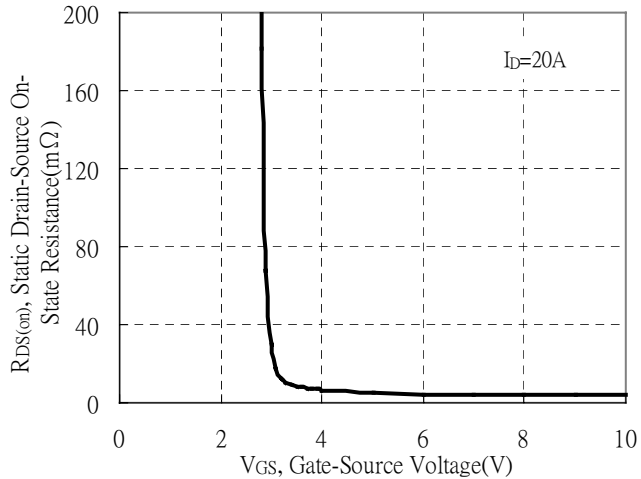

Drain-Source On-State Resistance vs Junction Temperature

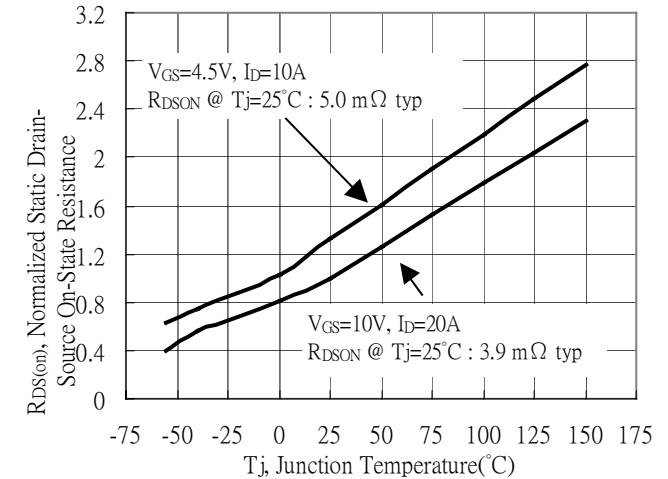

Typical Characteristics(Cont.)

Capacitance vs Drain-to-Source Voltage

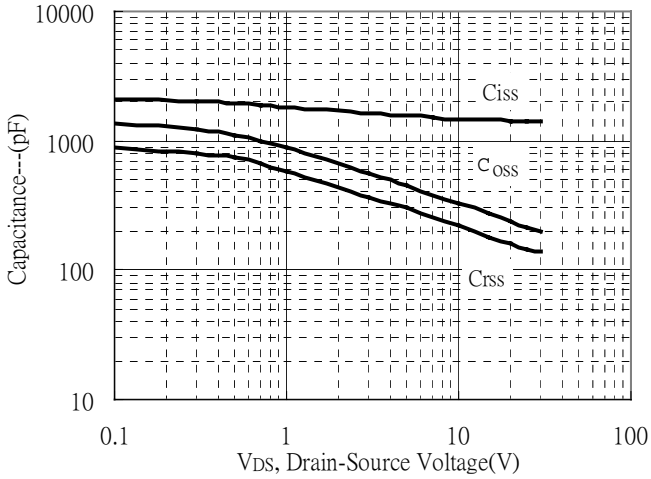

Threshold Voltage vs Junction Temperature

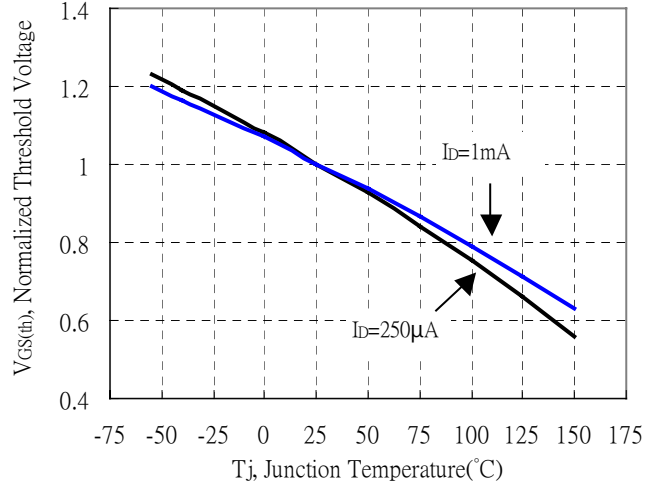

Forward Transfer Admittance vs Drain Current

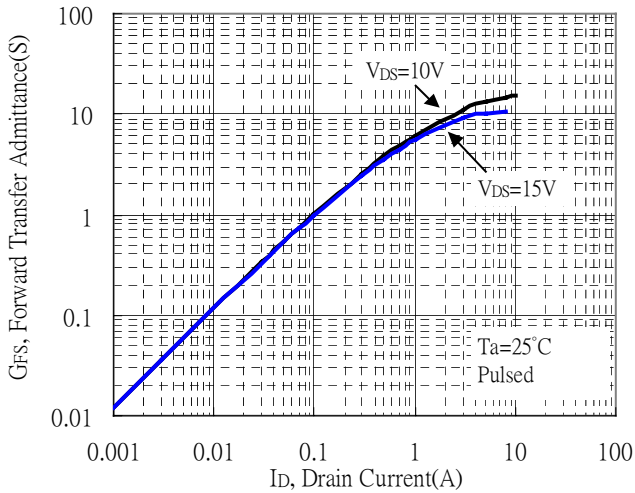

Gate Charge Characteristics

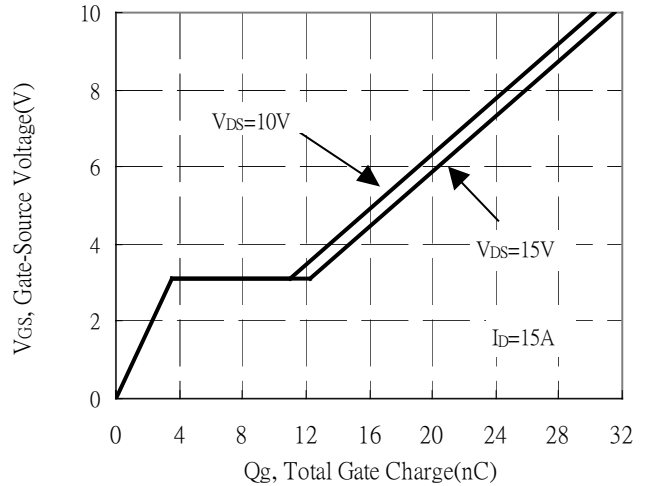

Maximum Safe Operating Area

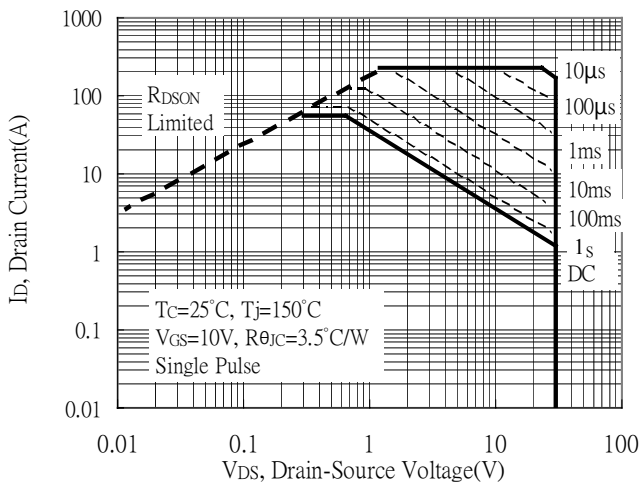

Maximum Drain Current vs Case Temperature

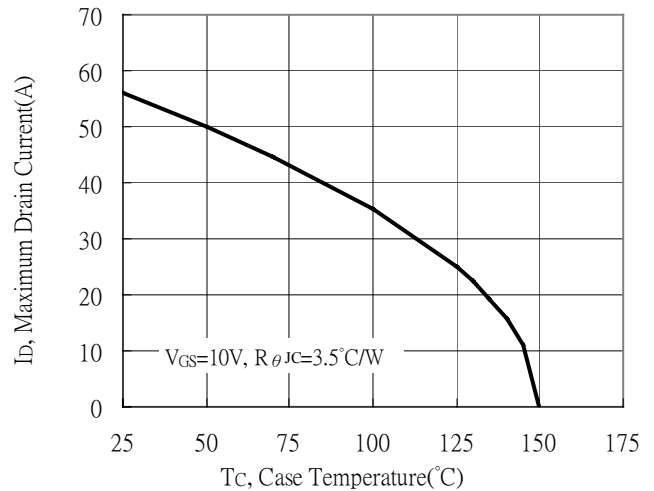



Typical Characteristics(Cont.)

Typical Transfer Characteristics

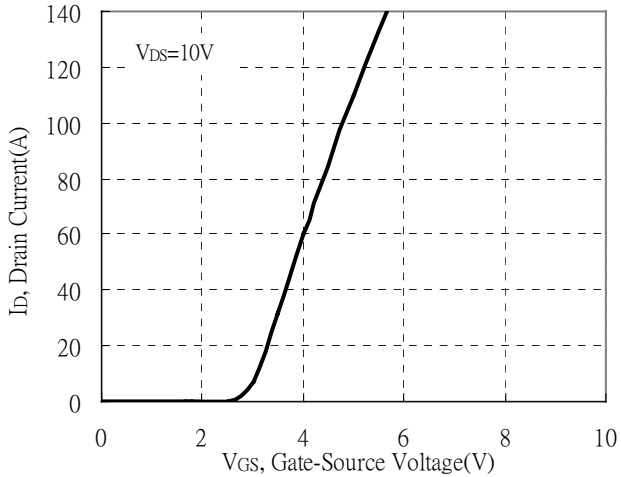

Single Pulse Power Rating, Junction to Ambient
(Note on page 2)

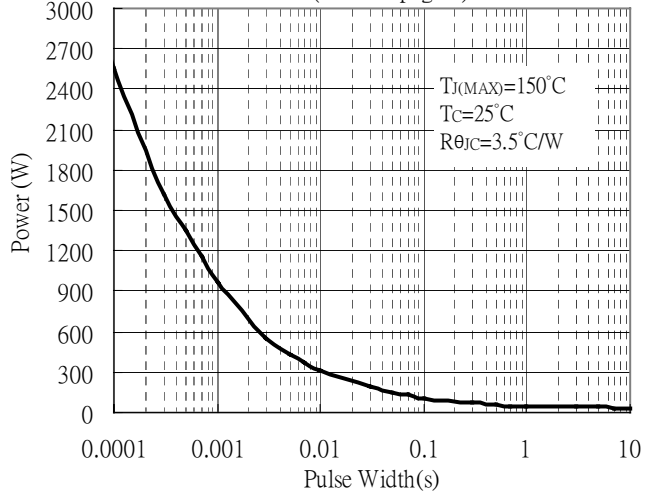

Transient Thermal Response Curves

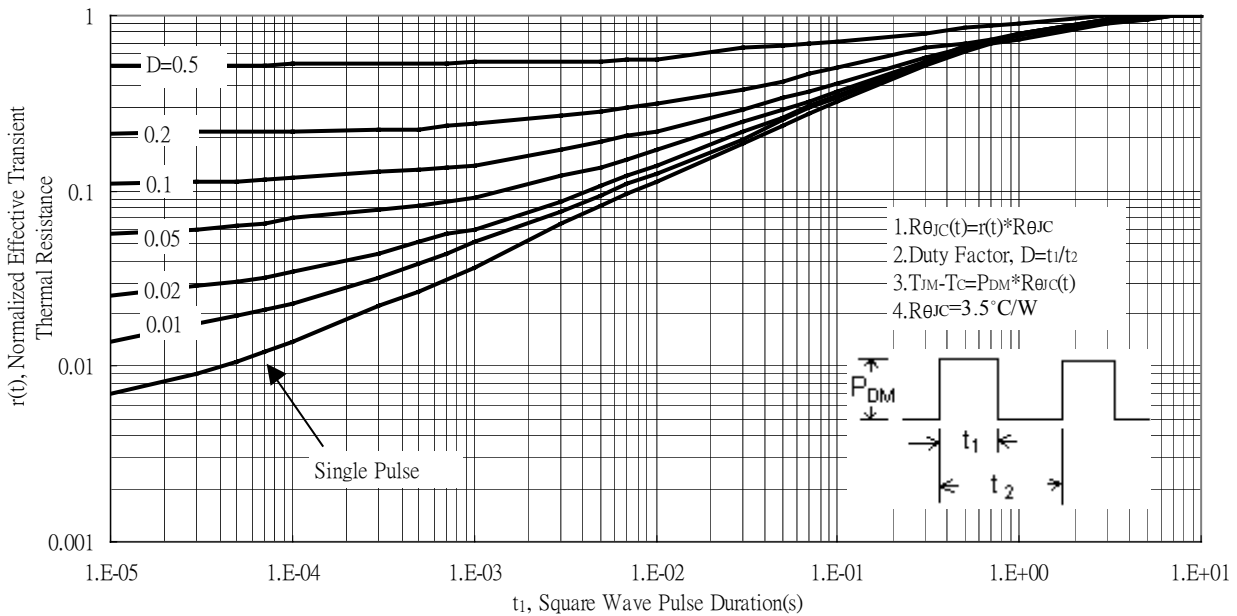

Reel Dimension

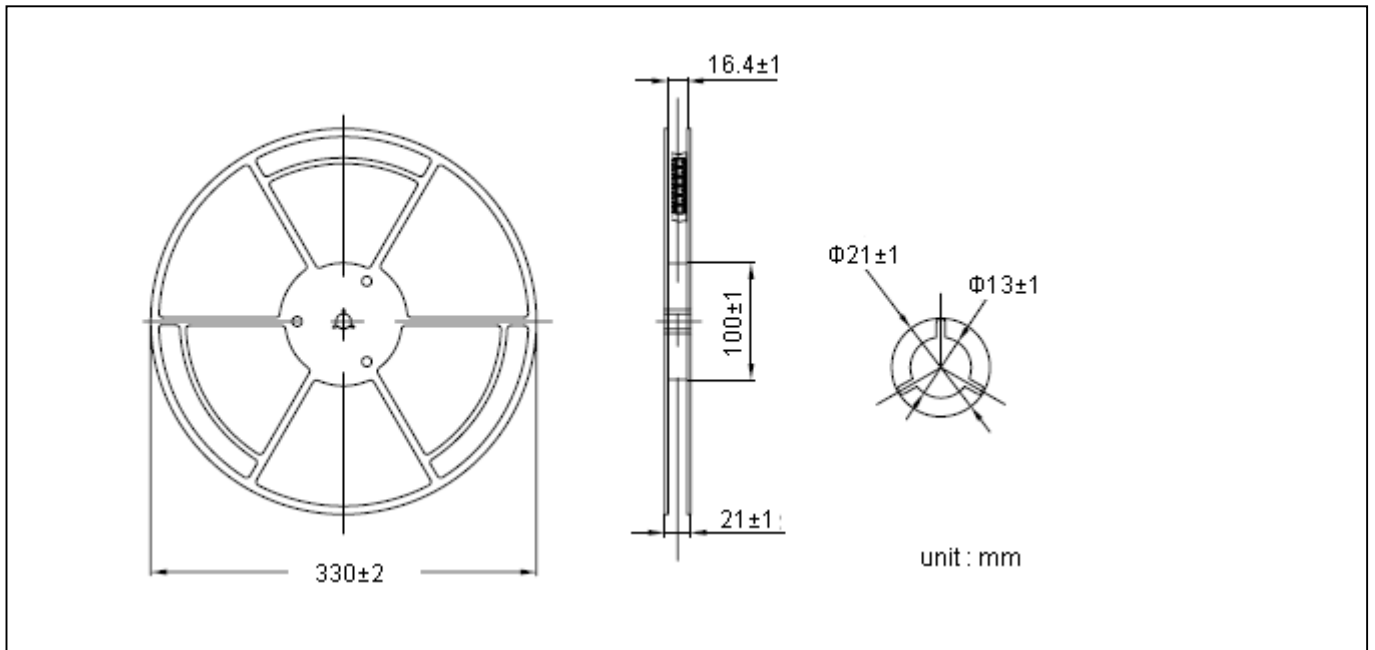

Carrier Tape Dimension

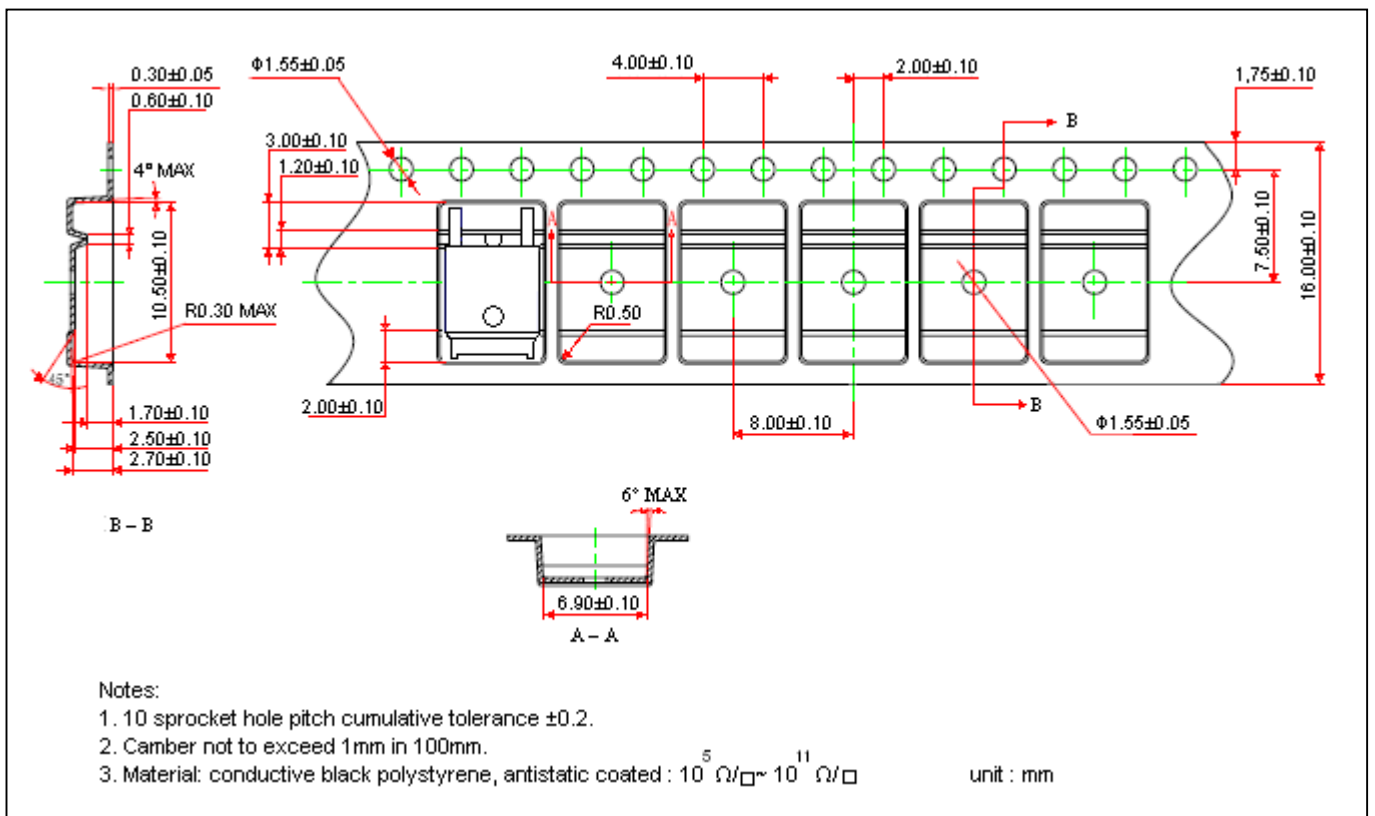

Recommended wave soldering condition

Product	Peak Temperature	Soldering Time
Pb-free devices	260 +0/-5 °C	5 +1/-1 seconds

Recommended temperature profile for IR reflow

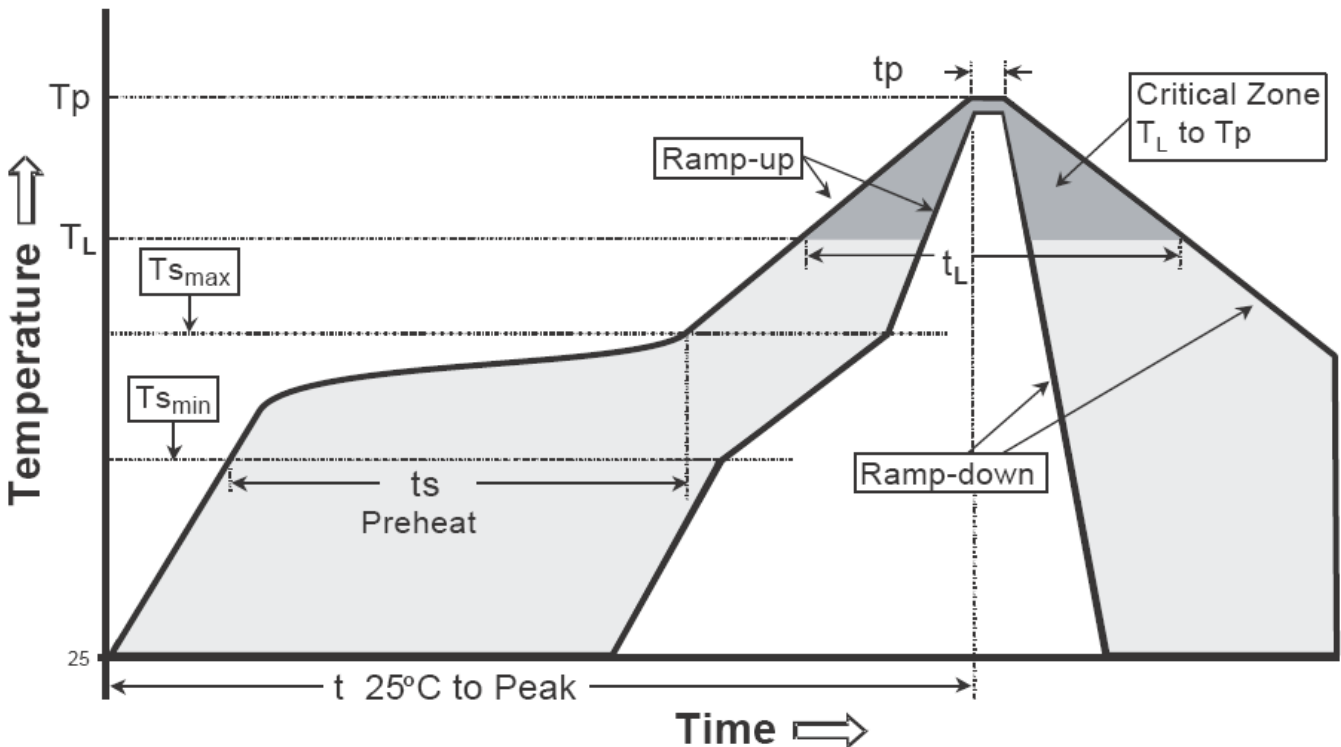

Profile feature	Sn-Pb eutectic Assembly	Pb-free Assembly
Average ramp-up rate (T _{smax} to T _p)	3°C/second max.	3°C/second max.
Preheat		
-Temperature Min(T _{s min})	100°C	150°C
-Temperature Max(T _{s max})	150°C	200°C
-Time(t _{s min} to t _{s max})	60-120 seconds	60-180 seconds
Time maintained above:		
-Temperature (T _L)	183°C	217°C
- Time (t _L)	60-150 seconds	60-150 seconds
Peak Temperature(T _P)	240 +0/-5 °C	260 +0/-5 °C
Time within 5°C of actual peak temperature(tp)	10-30 seconds	20-40 seconds
Ramp down rate	6°C/second max.	6°C/second max.
Time 25 °C to peak temperature	6 minutes max.	8 minutes max.

Note : All temperatures refer to topside of the package, measured on the package body surface.

TO-252 Dimension

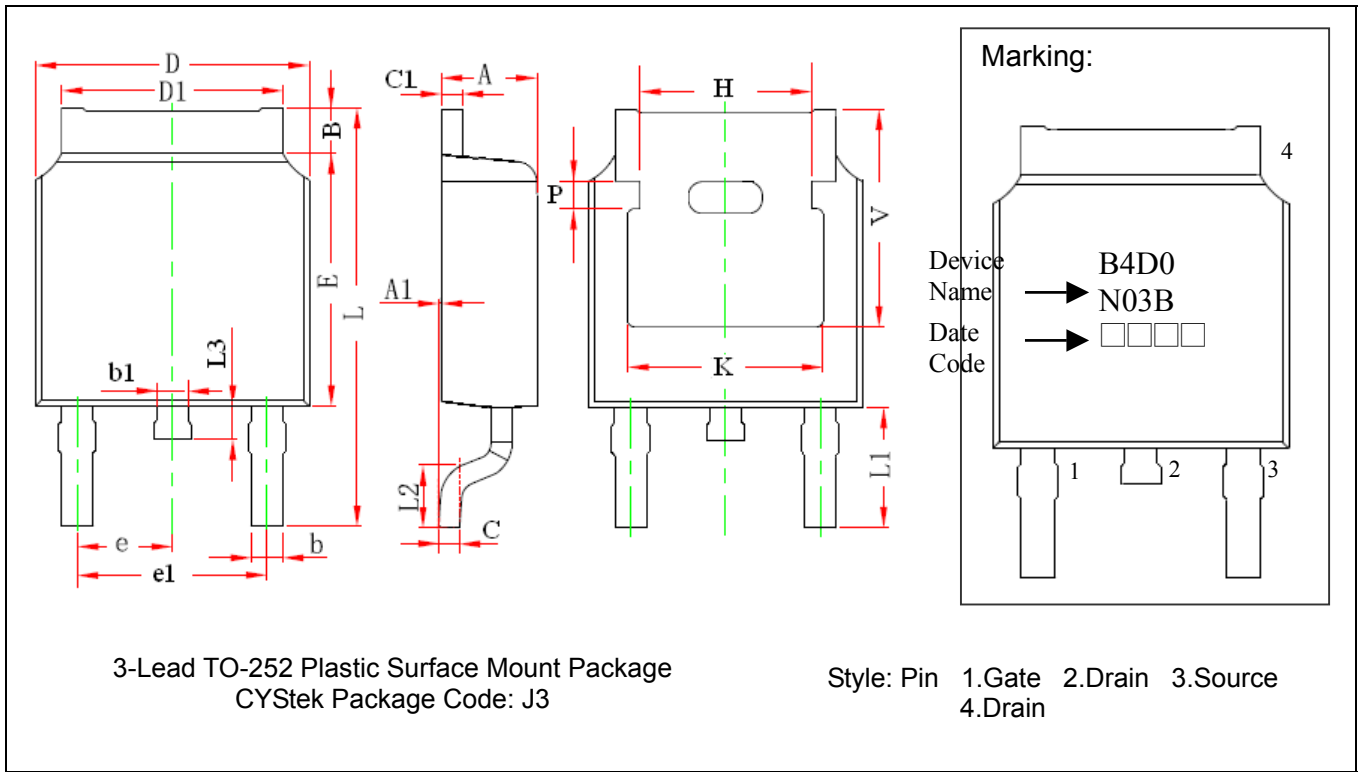

DIM	Inches		Millimeters		DIM	Inches		Millimeters	
	Min.	Max.	Min.	Max.		Min.	Max.	Min.	Max.
A	0.087	0.094	2.200	2.400	e	0.086	0.094	2.186	2.386
A1	0.000	0.005	0.000	0.127	e1	0.172	0.188	4.372	4.772
B	0.039	0.048	0.990	1.210	H	0.163	REF	4.140	REF
b	0.026	0.034	0.660	0.860	K	0.190	REF	4.830	REF
b1	0.026	0.034	0.660	0.860	L	0.386	0.409	9.800	10.400
C	0.018	0.023	0.460	0.580	L1	0.114	REF	2.900	REF
C1	0.018	0.023	0.460	0.580	L2	0.055	0.067	1.400	1.700
D	0.256	0.264	6.500	6.700	L3	0.024	0.039	0.600	1.000
D1	0.201	0.215	5.100	5.460	P	0.026	REF	0.650	REF
E	0.236	0.244	6.000	6.200	V	0.211	REF	5.350	REF

Notes: 1.Controlling dimension: millimeters.
 2.Maximum lead thickness includes lead finish thickness, and minimum lead thickness is the minimum thickness of base material.
 3.If there is any question with packing specification or packing method, please contact your local CYStek sales office.

Material:

- Lead : Pure tin plated.
- Mold Compound: Epoxy resin family, flammability solid burning class: UL94V-0.

Important Notice:

- All rights are reserved. Reproduction in whole or in part is prohibited without the prior written approval of CYStek.
- CYStek reserves the right to make changes to its products without notice.
- CYStek **semiconductor products are not warranted to be suitable for use in Life-Support Applications, or systems.**
- CYStek assumes no liability for any consequence of customer product design, infringement of patents, or application assistance.