

N-Channel Enhancement Mode Power MOSFET

MTB3D6N04RH8

BV_{DSS}	40 V
$I_D@V_{GS}=10V, T_C=25^\circ C$	65 A
$I_D@V_{GS}=10V, T_A=25^\circ C$	14.5A
$R_{DS(on)(typ)}@V_{GS}=10V, I_D=20A$	3.0 mΩ
$R_{DS(on)(typ)}@V_{GS}=4.5V, I_D=20A$	4.2 mΩ

Features

- Single Drive Requirement
- Low On-resistance
- Fast Switching Characteristic
- Pb-free lead plating and Halogen-free package

Symbol

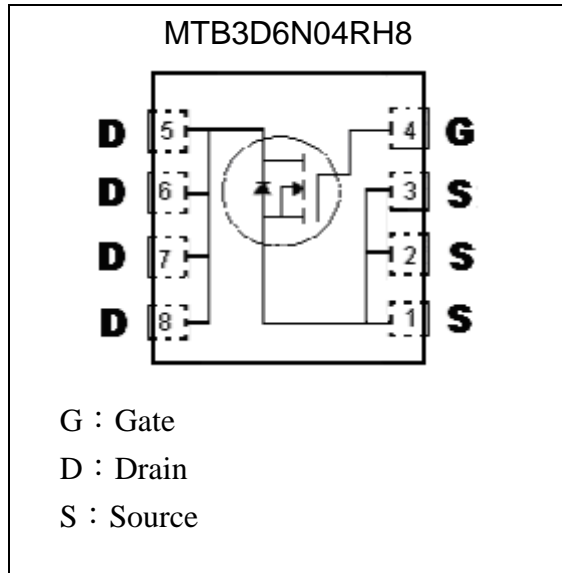

Outline

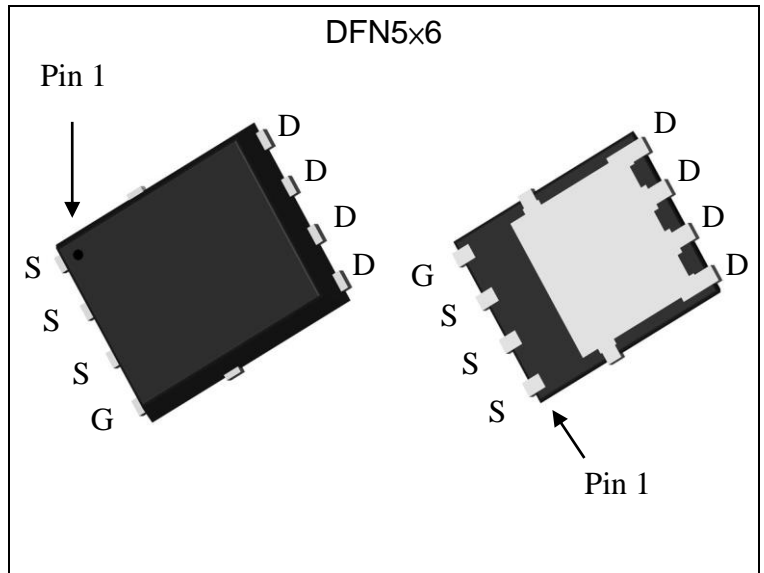

Ordering Information

Device	Package	Shipping
MTB3D6N04RH8-0-T6-G	DFN5x6 (Pb-free lead plating and halogen-free package)	3000 pcs / Tape & Reel

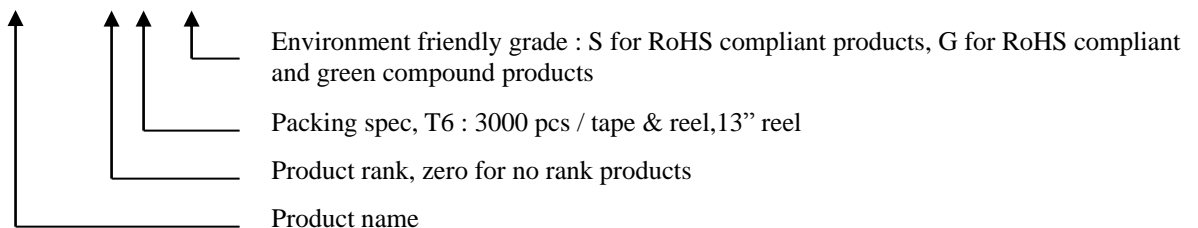



Absolute Maximum Ratings (Ta=25°C)

Parameter	Symbol	Limits	Unit	
Drain-Source Voltage	V _{DS}	40	V	
Gate-Source Voltage	V _{GS}	±20		
Continuous Drain Current @ T _C =25°C, V _{GS} =10V	I _D	65	A	
Continuous Drain Current @ T _C =100°C, V _{GS} =10V		41.1		
Continuous Drain Current @ T _A =25°C, V _{GS} =10V	I _{DSM}	14.5 *3		
Continuous Drain Current @ T _A =70°C, V _{GS} =10V		11.6 *3		
Pulsed Drain Current	I _{DM}	260 *1		
Avalanche Current @ L=0.5mH	I _{AS}	10		
Avalanche Energy @ L=0.5mH, I _D =10A, V _{DD} =15V	E _{AS}	25 *4	mJ	
Repetitive Avalanche Energy @ L=0.05mH	E _{AR}	5 *2		
Total Power Dissipation	P _D	T _C =25°C	50	W
		T _C =100°C	20	
	P _D SM	T _A =25°C	2.5	
		T _A =70°C	1.6	
Operating Junction and Storage Temperature Range	T _j , T _{stg}	-55~+150	°C	

Thermal Data

Parameter	Symbol	Value	Unit
Thermal Resistance, Junction-to-case, max	R _{th,j-c}	2.5	°C/W
Thermal Resistance, Junction-to-ambient, max	R _{th,j-a}	50 *3	

- Note : 1. Pulse width limited by maximum junction temperature
 2. Duty cycle ≤ 1%
 3. Surface mounted on 1 in² copper pad of FR-4 board, 125°C/W when mounted on minimum copper pad
 4. 100% tested by conditions of L=0.5mH, I_{AS}=2A, V_{GS}=10V, V_{DD}=15V

Characteristics (T_C=25°C, unless otherwise specified)

Symbol	Min.	Typ.	Max.	Unit	Test Conditions
Static					
BV _{DSS}	40	-	-	V	V _{GS} =0V, I _D =250μA
V _{GS(th)}	1.0	-	2.5		V _{DS} = V _{GS} , I _D =250μA
G _{FS} *1	-	29.4	-	S	V _{DS} =5V, I _D =10A
I _{GSS}	-	-	±100	nA	V _{GS} =±20V, V _{DS} =0V
I _{DSS}	-	-	1	μA	V _{DS} =32V, V _{GS} =0V
	-	-	10		V _{DS} =32V, V _{GS} =0V, T _j =85°C
R _{DS(ON)} *1	-	3.0	4.8	mΩ	V _{GS} =10V, I _D =20A
	-	4.2	6.8	mΩ	V _{GS} =4.5V, I _D =20A
Dynamic					
C _{iss}	-	1543	-	pF	V _{GS} =0V, V _{DS} =20V, f=1MHz
C _{oss}	-	935	-		
C _{rss}	-	77	-		





Qg *1,2	-	26.8	-	nC	V _{DS} =20V, V _{GS} =10V, I _D =20A
Qgs *1,2	-	4.7	-		
Qgd *1,2	-	5.3	-		
t _{d(ON)} *1,2	-	14	-	ns	V _{DS} =20V, I _D =20A, V _{GS} =10V, R _{GS} =1 Ω
t _r *1,2	-	13.8	-		
t _{d(OFF)} *1,2	-	39	-		
t _f *1,2	-	9	-		
R _g	-	1	-	Ω	f=1MHz
Source-Drain Diode					
I _S *1	-	-	65	A	
I _{SM} *3	-	-	260		
V _{SD} *1	-	0.83	1.2	V	I _S =20A, V _{GS} =0V
t _{rr}	-	34.1	-	ns	I _F =20A, dI _F /dt=100A/μs
Q _{rr}	-	18.6	-	nC	

Note : *1.Pulse Test : Pulse Width ≤300μs, Duty Cycle≤2%
 *2.Independent of operating temperature
 *3.Pulse width limited by maximum junction temperature.

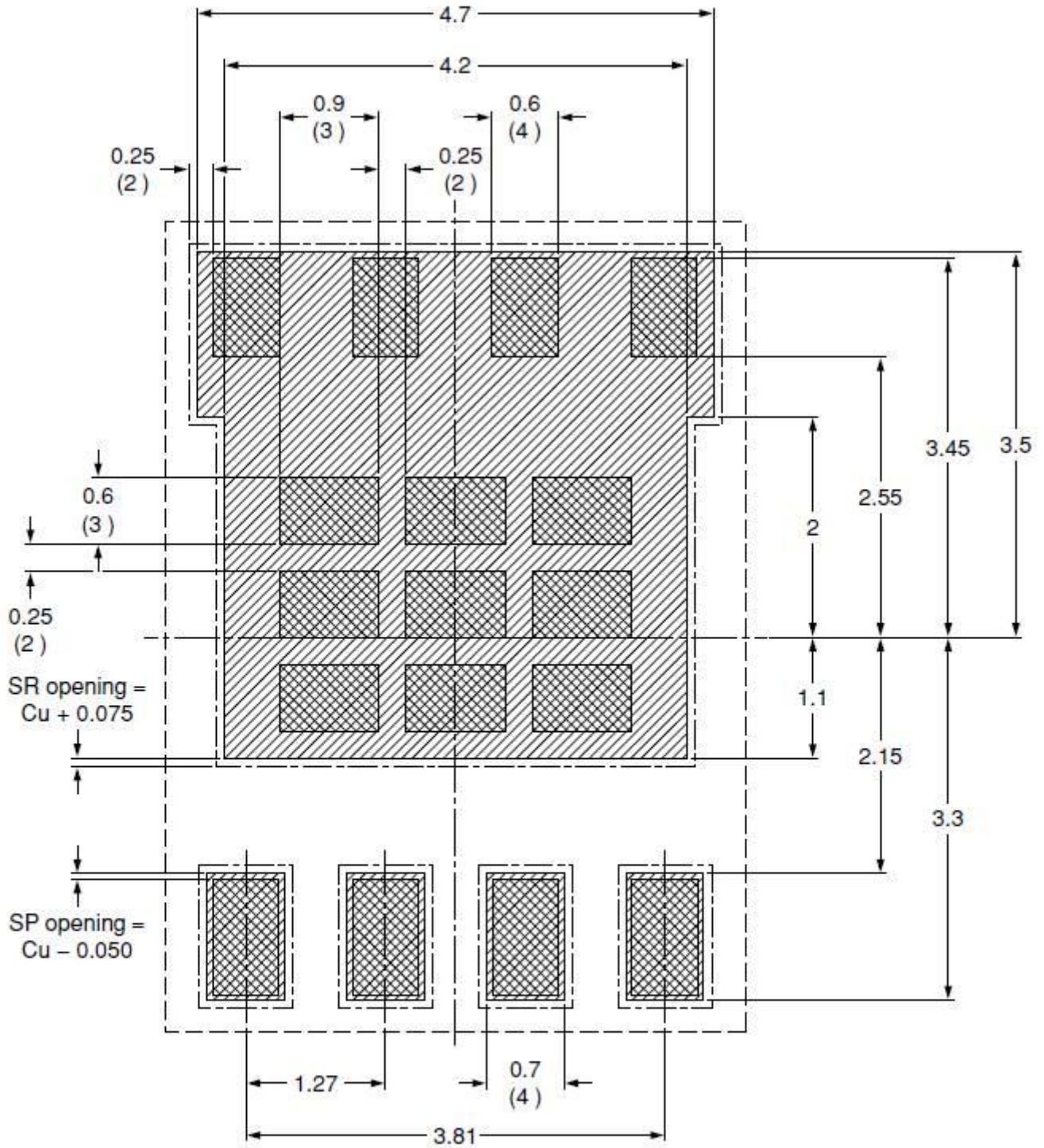
Recommended Soldering Footprint & Stencil Design

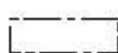
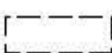

- | | |
|---|--|
|  solder lands |  solder paste
125 μm stencil |
|  solder resist |  occupied area |

unit : mm

Typical Characteristics

Typical Output Characteristics

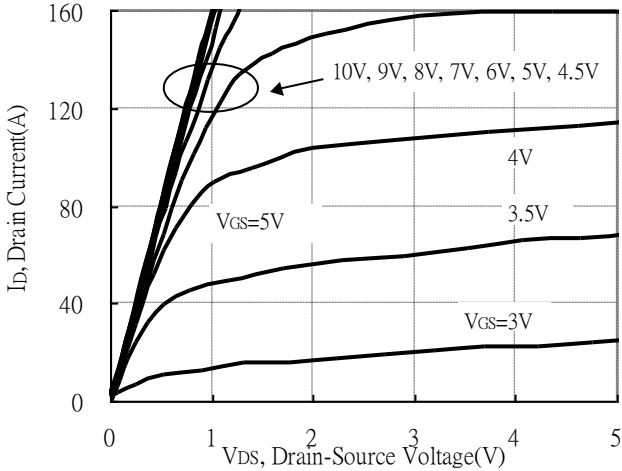

Brekdown Voltage vs Ambient Temperature

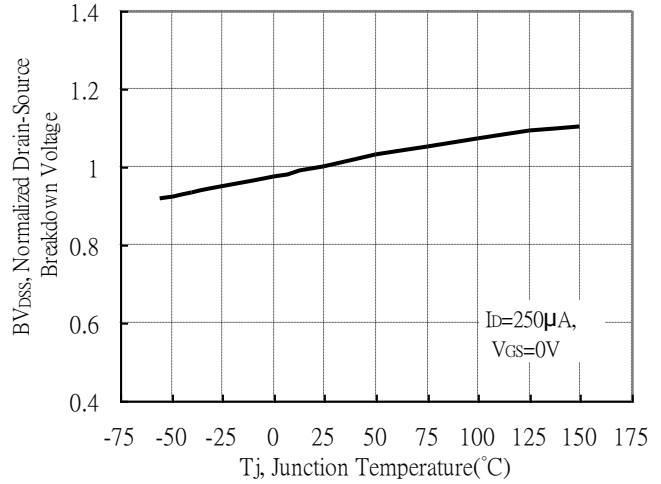

Static Drain-Source On-State resistance vs Drain Current

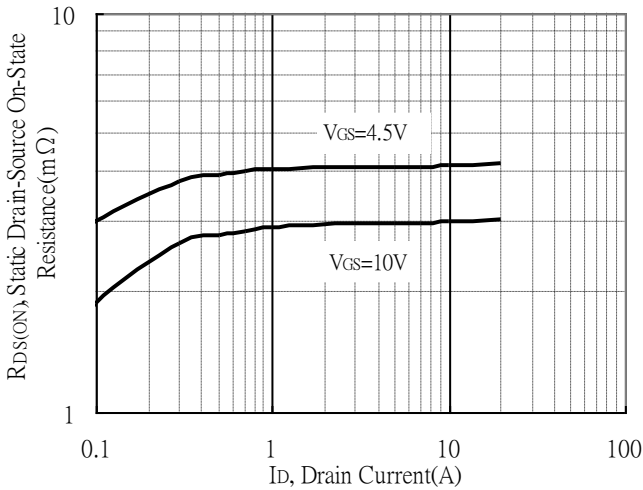

Reverse Drain Current vs Source-Drain Voltage

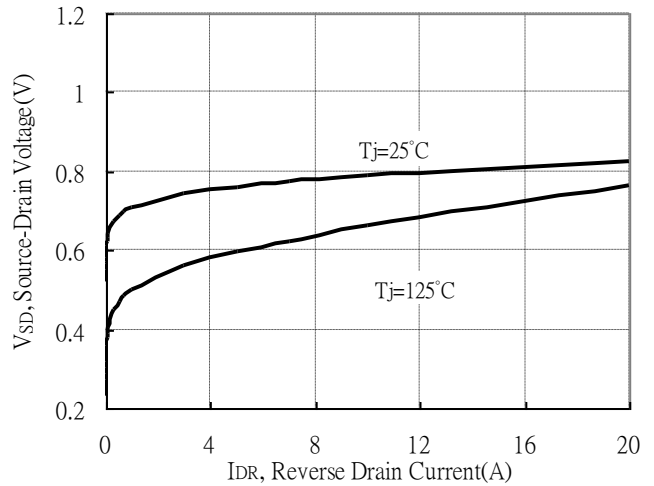

Static Drain-Source On-State Resistance vs Gate-Source Voltage

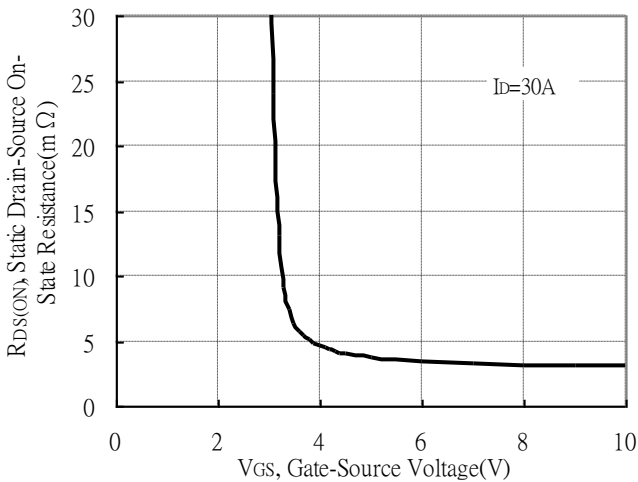

Drain-Source On-State Resistance vs Junction Temperature

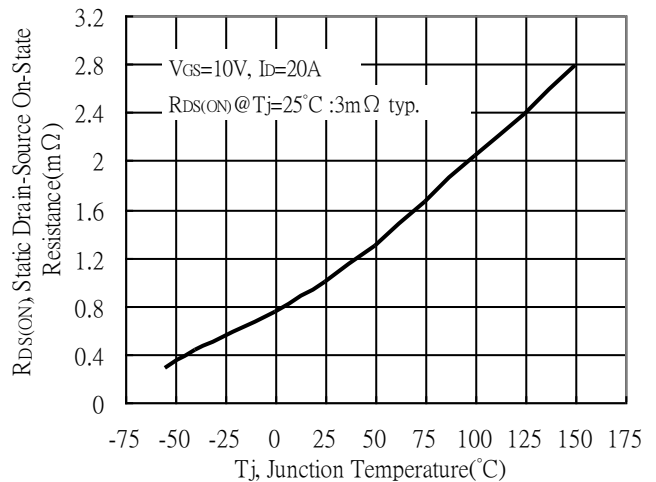

Typical Characteristics(Cont.)

Capacitance vs Drain-to-Source Voltage

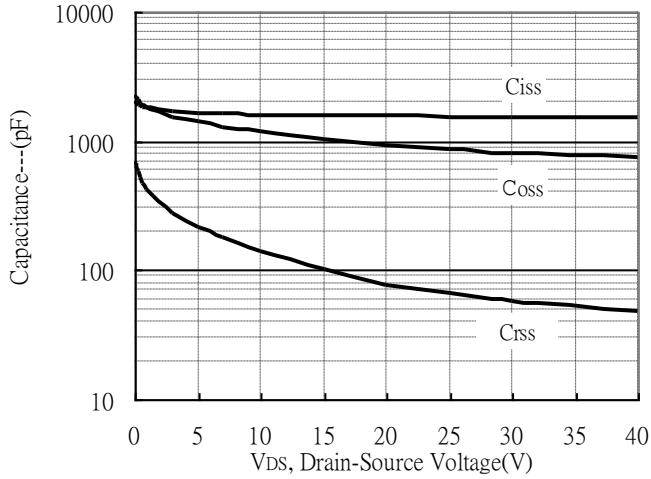

Threshold Voltage vs Junction Temperature

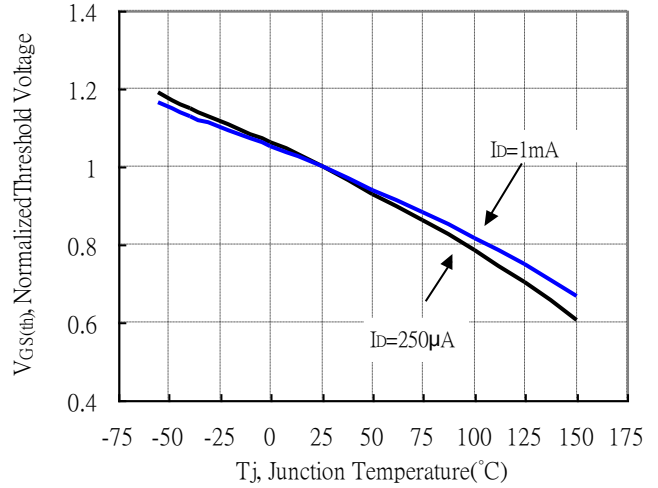

Forward Transfer Admittance vs Drain Current

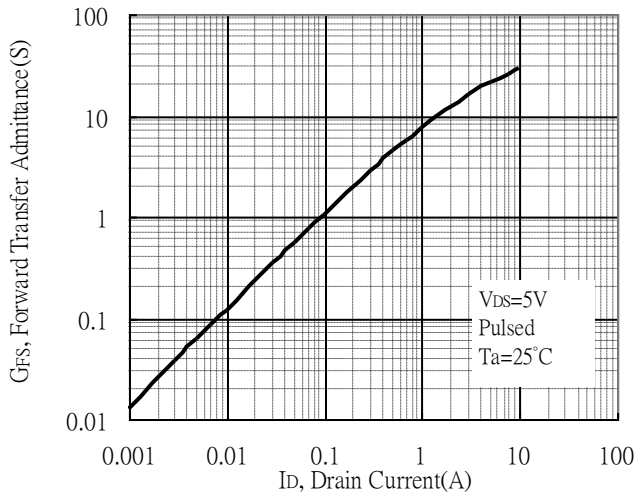

Gate Charge Characteristics

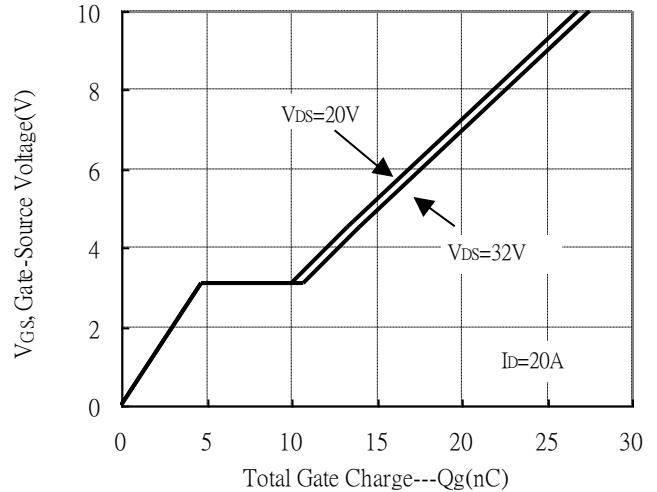

Maximum Safe Operating Area

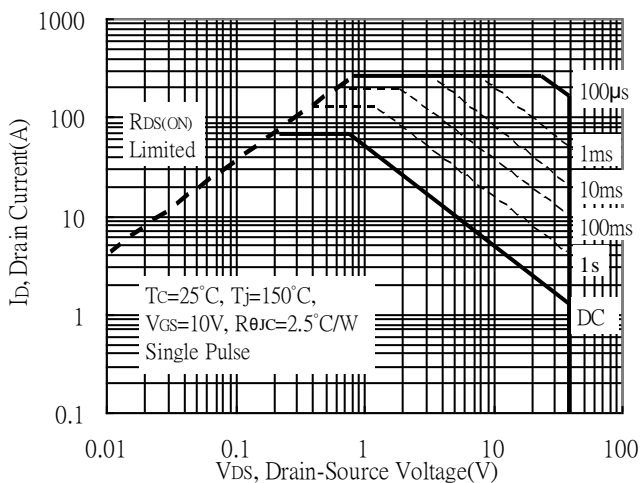

Maximum Drain Current vs Case Temperature

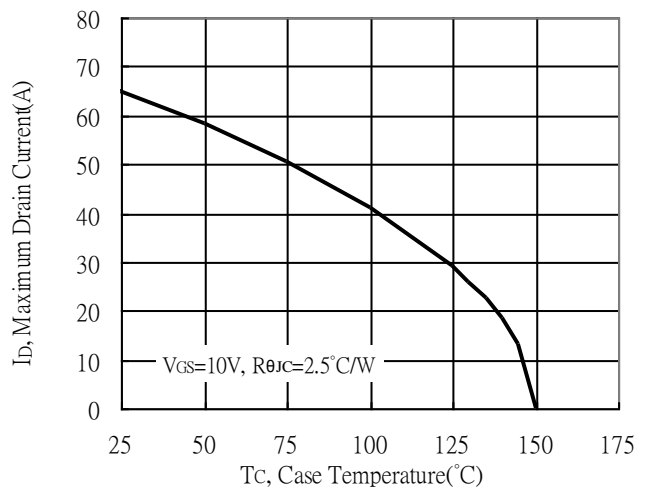



Typical Characteristics(Cont.)

Typical Transfer Characteristics

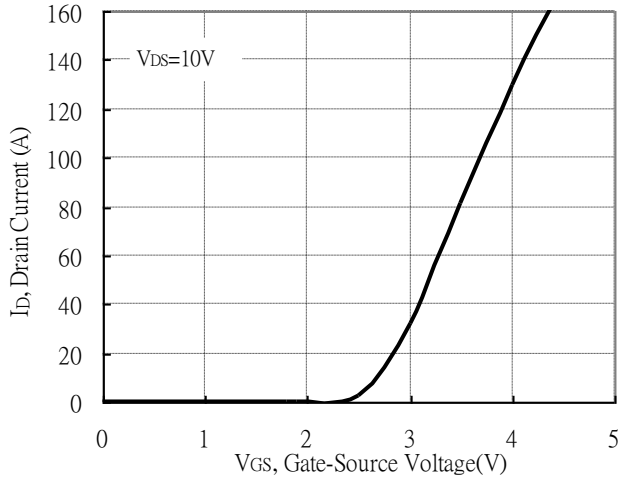

Single Pulse Maximum Power Dissipation

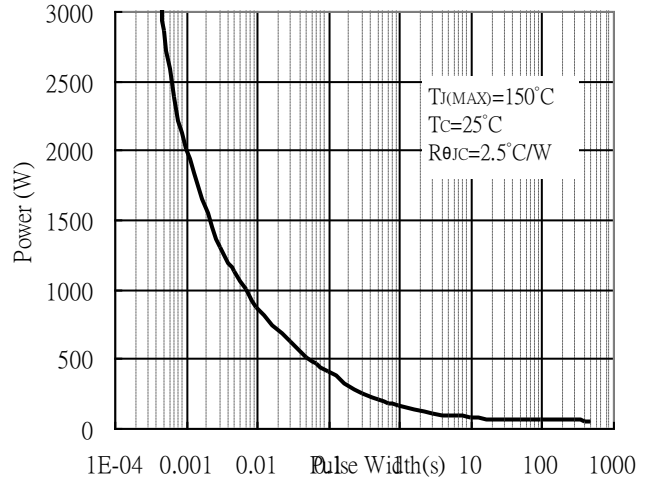

Transient Thermal Response Curves

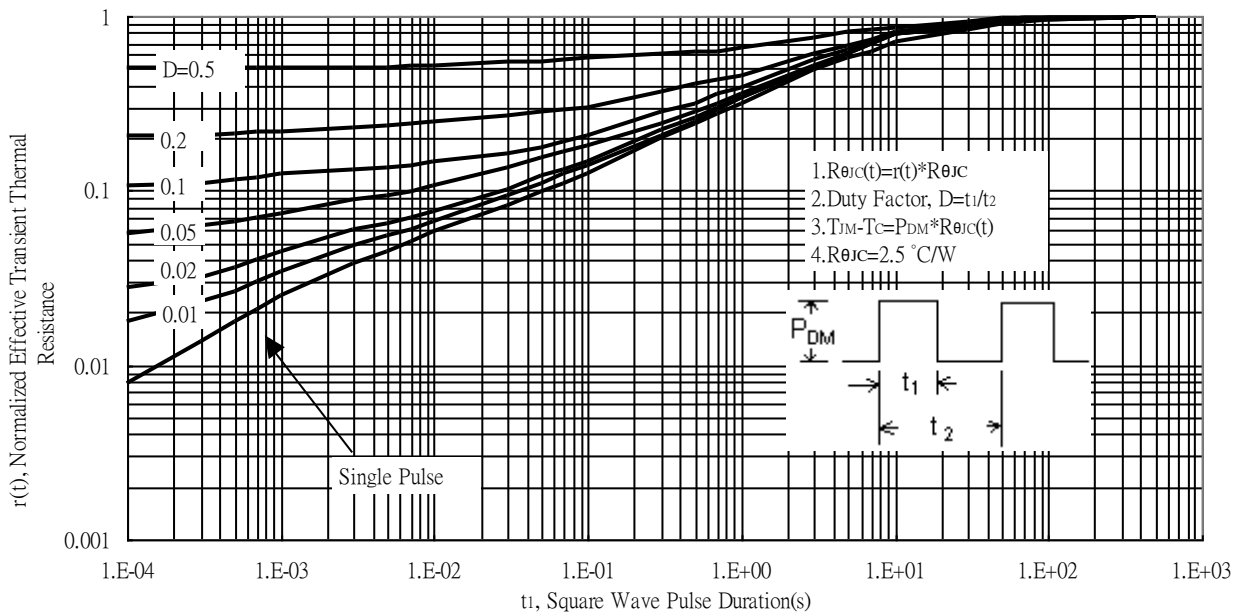

Reel Dimension

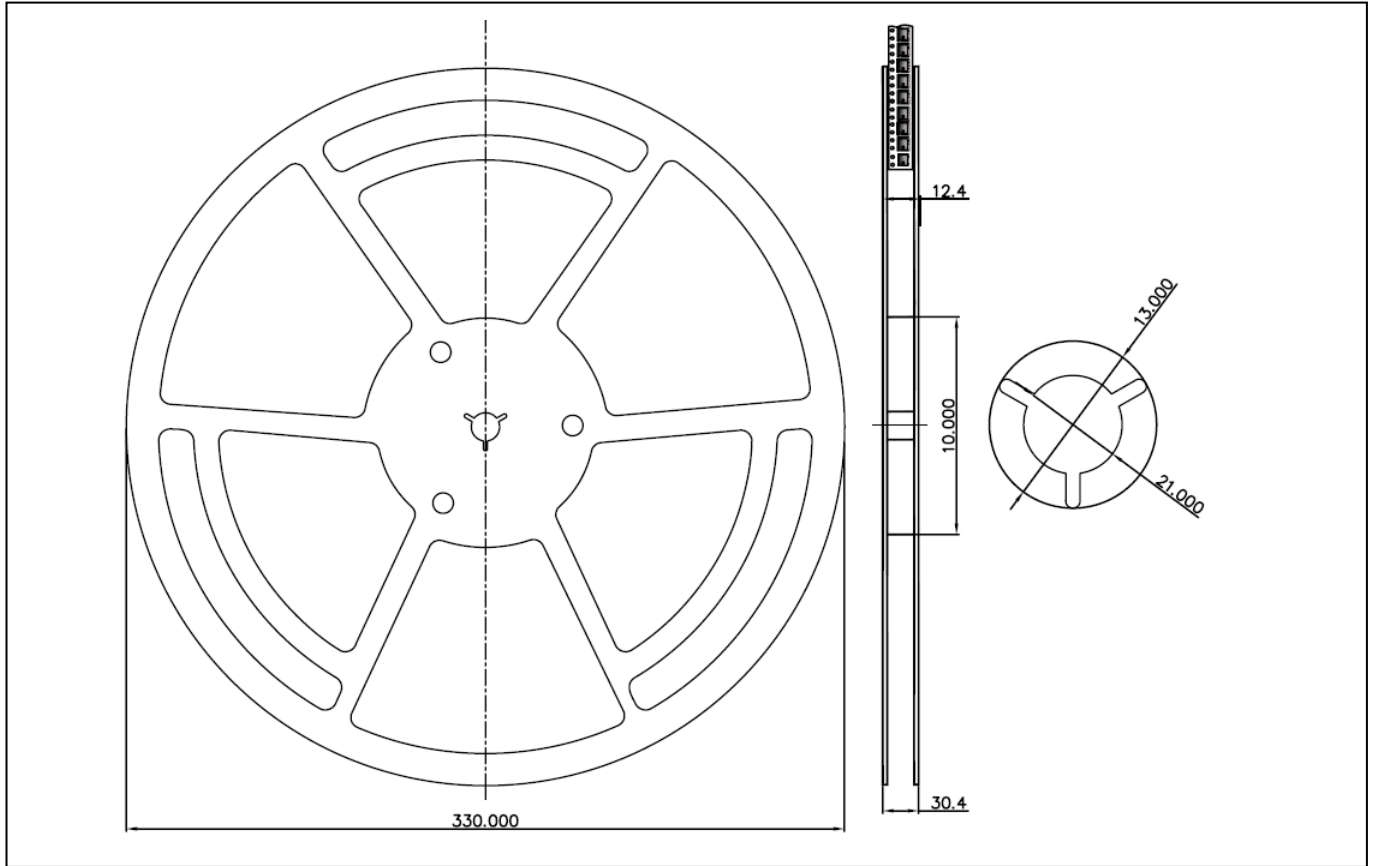

Carrier Tape Dimension

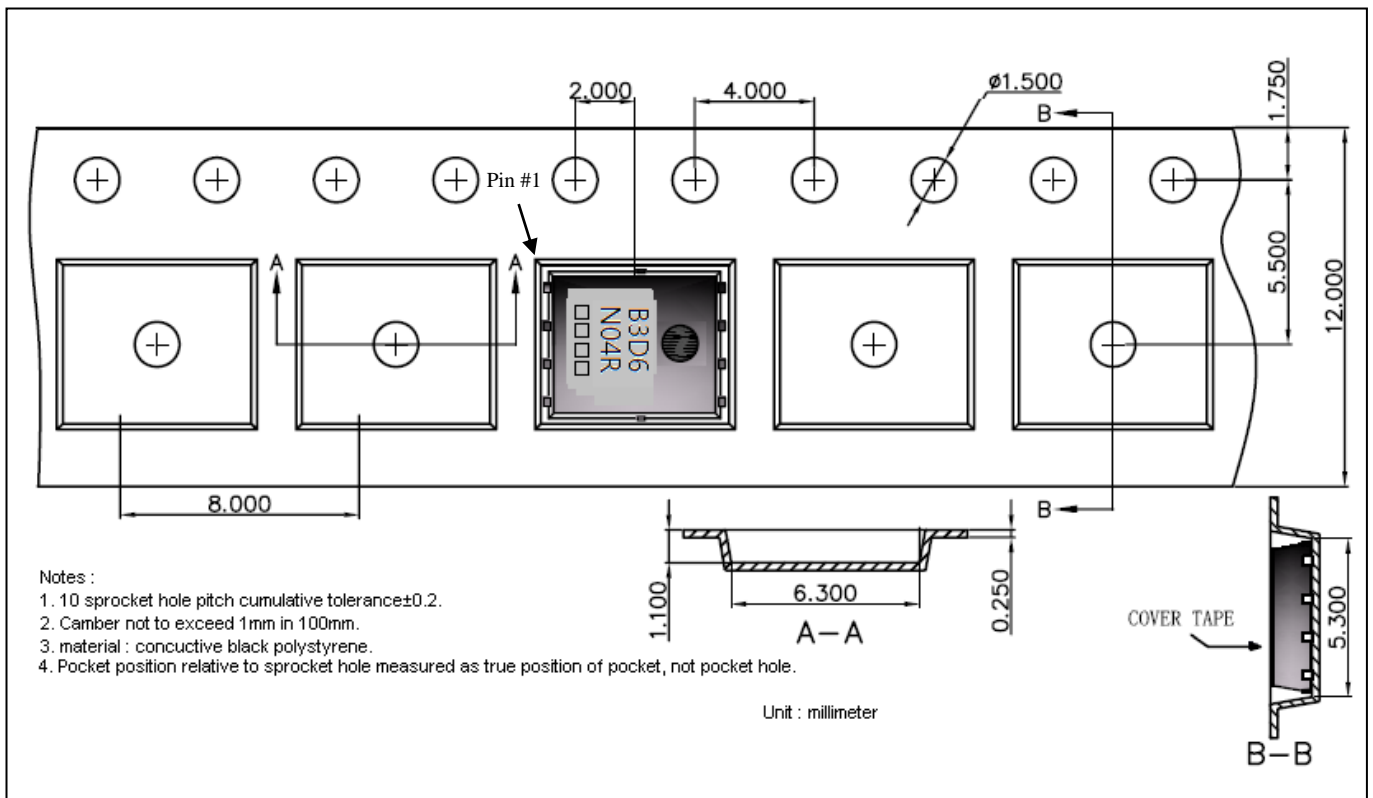

Notes :

1. 10 sprocket hole pitch cumulative tolerance±0.2.
2. Camber not to exceed 1mm in 100mm.
3. material : conductive black polystyrene.
4. Pocket position relative to sprocket hole measured as true position of pocket, not pocket hole.

Recommended wave soldering condition

Product	Peak Temperature	Soldering Time
Pb-free devices	260 +0/-5 °C	5 +1/-1 seconds

Recommended temperature profile for IR reflow

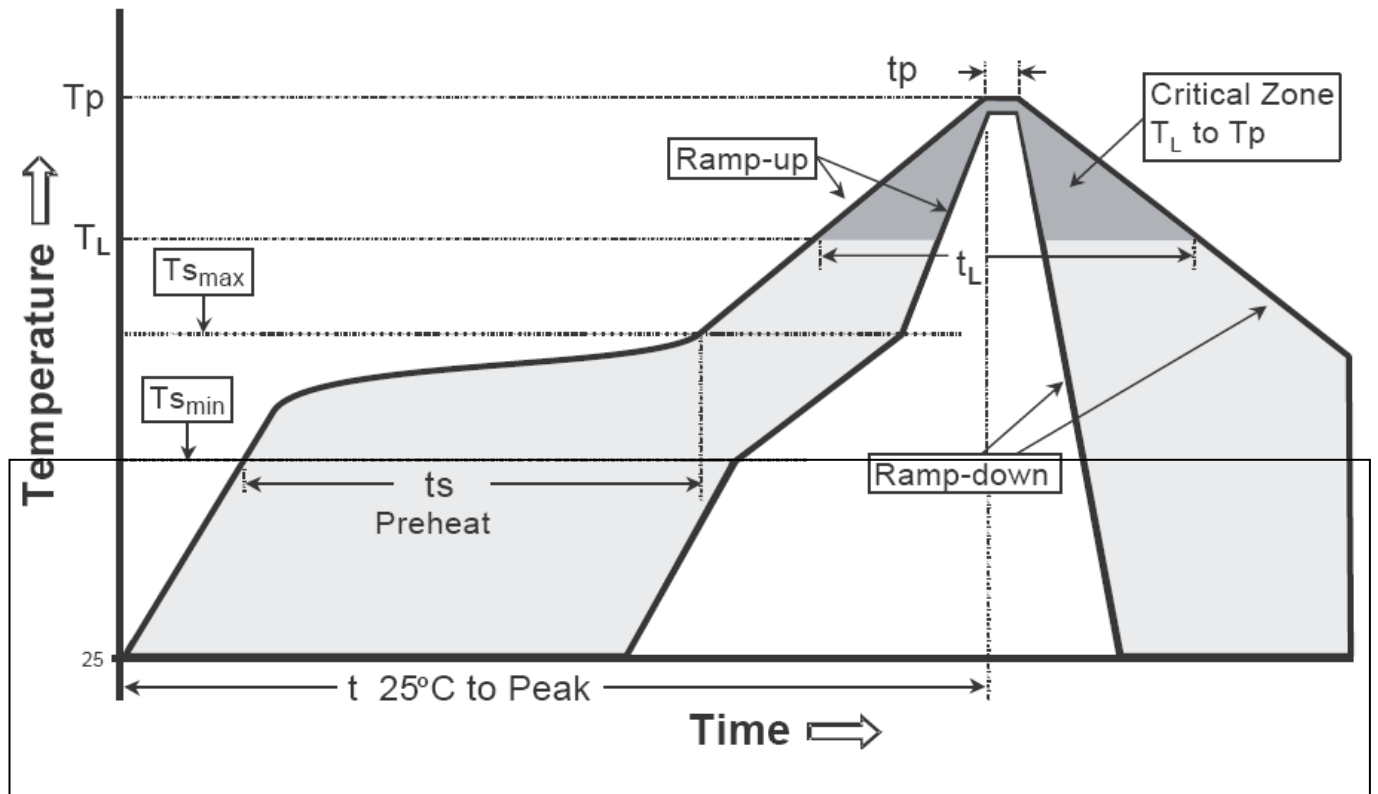

Profile feature	Sn-Pb eutectic Assembly	Pb-free Assembly
Average ramp-up rate (T _{smax} to T _p)	3°C/second max.	3°C/second max.
Preheat		
-Temperature Min(T _{s min})	100°C	150°C
-Temperature Max(T _{s max})	150°C	200°C
-Time(t _{s min} to t _{s max})	60-120 seconds	60-180 seconds
Time maintained above:		
-Temperature (T _L)	183°C	217°C
- Time (t _L)	60-150 seconds	60-150 seconds
Peak Temperature(T _p)	240 +0/-5 °C	260 +0/-5 °C
Time within 5°C of actual peak temperature(tp)	10-30 seconds	20-40 seconds
Ramp down rate	6°C/second max.	6°C/second max.
Time 25 °C to peak temperature	6 minutes max.	8 minutes max.

Note : All temperatures refer to topside of the package, measured on the package body surface.

DFN5x6 Dimension

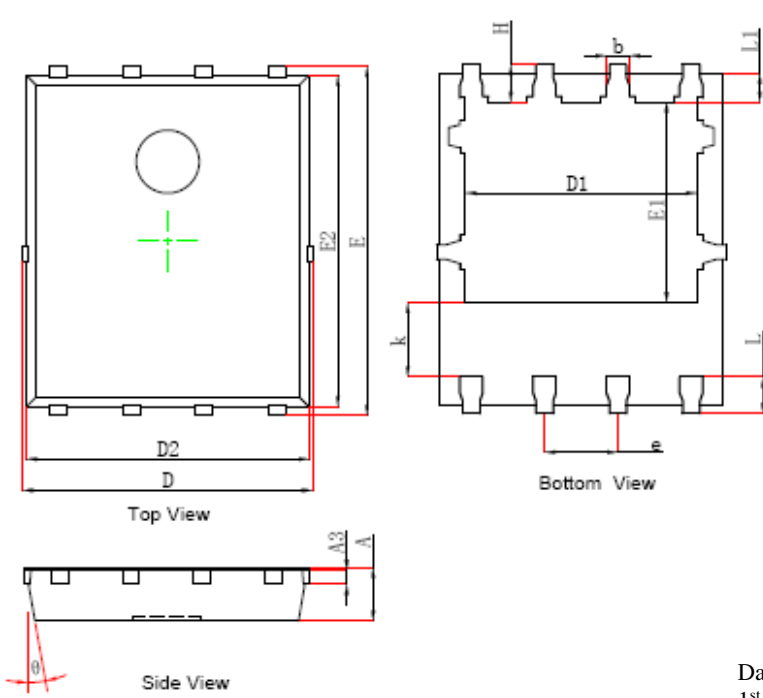

Marking :

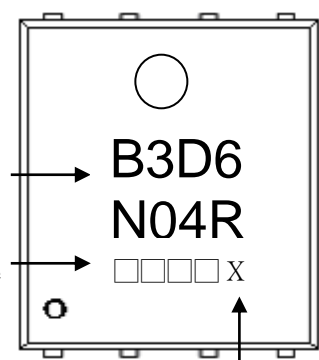

Device Name → **B3D6**

Date Code → **N04R**

Assembly Site code : Blank → Site 1
 G → Site 2

8-Lead DFN5x6 Plastic Package
 CYS Package Code : H8

Date Code(counting from left to right) :
 1st code: year code, the last digit of Christian year
 2nd code : month code, Jan→A, Feb→B, Mar→C, Apr→D
 May→E, Jun→F, Jul→G, Aug→H, Sep→J,
 Oct→K, Nov→L, Dec→M
 3rd and 4th codes : production serial number, 01~99

DIM	Millimeters		Inches		DIM	Millimeters		Inches	
	Min.	Max.	Min.	Max.		Min.	Max.	Min.	Max.
A	0.900	1.100	0.035	0.043	k	1.100	-	0.043	-
A3	0.200	0.300	0.008	0.012	b	0.330	0.510	0.013	0.020
D	4.944	5.096	0.195	0.201	e	1.270 TYP.		0.050 TYP.	
E	5.900	6.126	0.232	0.241	L	0.510	0.711	0.020	0.028
D1	3.670	4.110	0.144	0.162	L1	0.310	0.576	0.012	0.023
E1	3.375	3.780	0.133	0.149	H	0.410	0.726	0.016	0.029
D2	4.800	5.000	0.189	0.197	θ	8°	12°	8°	12°
E2	5.674	5.826	0.223	0.229					

Notes: 1.Controlling dimension: millimeters.
 2.Maximum lead thickness includes lead finish thickness, and minimum lead thickness is the minimum thickness of base material.
 3.If there is any question with packing specification or packing method, please contact your local CYStek sales office.

Material:

- Lead: Pure tin plated.
- Mold Compound: Epoxy resin family, flammability solid burning class: UL94V-0.

Important Notice:

- All rights are reserved. Reproduction in whole or in part is prohibited without the prior written approval of CYStek.
- CYStek reserves the right to make changes to its products without notice.
- CYStek **semiconductor products are not warranted to be suitable for use in Life-Support Applications, or systems.**
- CYStek assumes no liability for any consequence of customer product design, infringement of patents, or application assistance.