

N-Channel Enhancement Mode Power MOSFET

MTB1D5N03H8

BV_{DSS}	30V
I_D@V_{GS}=10V, T_C=25°C	156A (silicon limit)
I_D@V_{GS}=10V, T_C=25°C	84A (package limit)
I_D@V_{GS}=10V, T_A=25°C	23.5A
R_{DS(ON)}@V_{GS}=10V, I_D=20A	1.3mΩ (typ)
R_{DS(ON)}@V_{GS}=4.5V, I_D=20A	1.6mΩ (typ)

Features

- Low On Resistance
- Simple Drive Requirement
- Low Gate Charge
- Fast Switching Characteristic
- Pb-free lead plating and Halogen-free package

Symbol

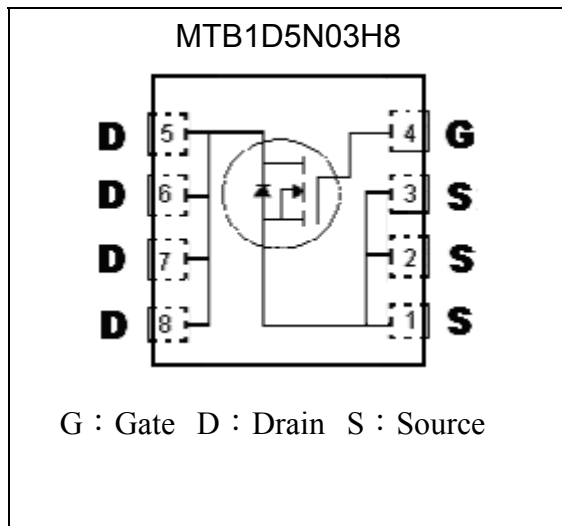

Outline

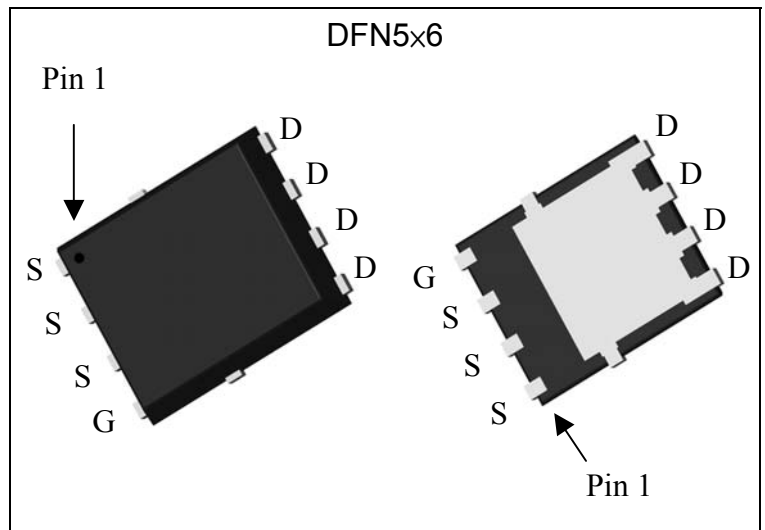

Ordering Information

Device	Package	Shipping
MTB1D5N03H8-0-T6-G	DFN 5 ×6 (Pb-free lead plating and halogen-free package)	3000 pcs / tape & reel

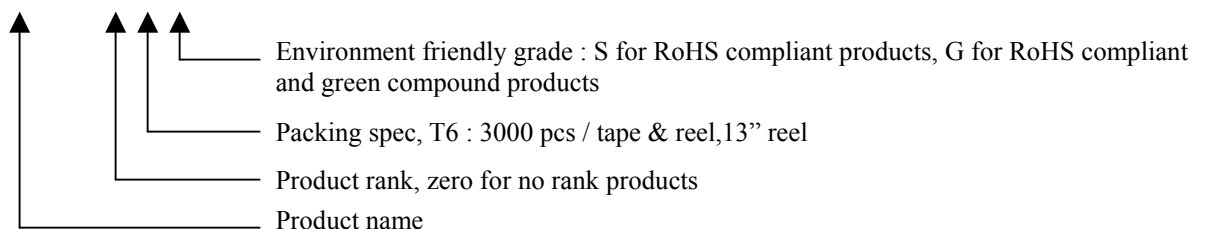

**Absolute Maximum Ratings** ($T_C=25^{\circ}\text{C}$, unless otherwise noted)

Parameter	Symbol	Limits	Unit	
Drain-Source Voltage (Note 1)	V_{DS}	30	V	
Gate-Source Voltage	V_{GS}	± 20		
Continuous Drain Current @ $T_C=25^{\circ}\text{C}$, $V_{GS}=10\text{V}$ (silicon limit) (Note 5)	I_D	156	A	
Continuous Drain Current @ $T_C=100^{\circ}\text{C}$, $V_{GS}=10\text{V}$ (silicon limit) (Note 5)		110		
Continuous Drain Current @ $T_C=25^{\circ}\text{C}$, $V_{GS}=10\text{V}$ (package limit) (Note 1)		84		
Continuous Drain Current @ $T_A=25^{\circ}\text{C}$, $V_{GS}=10\text{V}$ (Note 2)	I_{DSM}	23.5		
Continuous Drain Current @ $T_A=70^{\circ}\text{C}$, $V_{GS}=10\text{V}$ (Note 2)		18.8		
Pulsed Drain Current @ $V_{GS}=10\text{V}$ (Note 3)	I_{DM}	450		
Avalanche Current @ $L=0.1\text{mH}$ (Note 3)	I_{AS}	80		
Single Pulse Avalanche Energy @ $L=1\text{mH}$, $I_D=50\text{Amps}$, $V_{DD}=15\text{V}$ (Note 4)	E_{AS}	1250	mJ	
Repetitive Avalanche Energy (Note 3)	E_{AR}	12.5		
Power Dissipation	P_D	$T_C=25^{\circ}\text{C}$ (Note 1)	125	W
		$T_C=100^{\circ}\text{C}$ (Note 1)	62.5	
	P_{DSM}	$T_A=25^{\circ}\text{C}$ (Note 2)	2.5	
		$T_A=70^{\circ}\text{C}$ (Note 2)	1.6	
Operating Junction and Storage Temperature	T_J, T_{stg}	-55~+175	$^{\circ}\text{C}$	

*Drain current limited by maximum junction temperature

Thermal Data

Parameter	Symbol	Value	Unit
Thermal Resistance, Junction-to-case, max	$R_{\theta JC}$	1.2	$^{\circ}\text{C}/\text{W}$
Thermal Resistance, Junction-to-ambient, max (Note 2)	$R_{\theta JA}$	50	

- Note : 1. The power dissipation P_D is based on $T_{J(\text{MAX})}=175^{\circ}\text{C}$, using junction-to-case thermal resistance, and is more useful in setting the upper dissipation limit for cases where additional heatsinking is used.
2. The value of $R_{\theta JA}$ is measured with the device mounted on 1 in² FR-4 board with 2 oz. copper, in a still air environment with $T_A=25^{\circ}\text{C}$. The value in any given application depends on the user's specific board design. The power dissipation P_{DSM} is based on $R_{\theta JA}$ and the maximum allowed junction temperature of 150°C , and the maximum temperature of 175°C may be used if the PCB allows it.
3. Pulse width limited by junction temperature $T_{J(\text{MAX})}=175^{\circ}\text{C}$.
4. Ratings are based on low frequency and low duty cycles to keep initial $T_J=25^{\circ}\text{C}$. 100% tested by conditions of $V_{DD}=15\text{V}$, $I_D=20\text{A}$, $L=1\text{mH}$, $V_{GS}=10\text{V}$.
5. Calculated continuous drain current based on maximum allowable junction temperature.
6. The static characteristics are obtained using $<300\mu\text{s}$ pulses, duty cycle 0.5% maximum.
7. The $R_{\theta JA}$ is the sum of thermal resistance from junction to case $R_{\theta JC}$ and case to ambient.



Characteristics (Tj=25°C, unless otherwise specified)

Symbol	Min.	Typ.	Max.	Unit	Test Conditions
Static					
BV _{DSS}	30	-	-	V	V _{GS} =0V, I _D =250μA
ΔBV _{DSS} /ΔT _j	-	0.024	-	V/°C	Reference to 25°C, I _D =250μA
V _{GS(th)}	1	-	2.5	V	V _{DS} = V _{GS} , I _D =250μA
*G _{FS}	-	51.9	-	S	V _{DS} =10V, I _D =20A
I _{GSS}	-	-	±100	nA	V _{GS} =±20V
I _{DSS}	-	-	1	μA	V _{DS} =24V, V _{GS} =0V
	-	-	5		V _{DS} =24V, V _{GS} =0V, T _j =55°C
*R _{DS(ON)}	-	1.3	1.7	mΩ	V _{GS} =10V, I _D =20A
	-	1.6	2.2		V _{GS} =4.5V, I _D =20A
Dynamic					
*Q _g (V _{GS} =10V)	-	144.8	-	nC	V _{DS} =20V, I _D =20A, V _{GS} =10V
*Q _g (V _{GS} =4.5V)	-	75.3	-		
*Q _{gs}	-	21	-		
*Q _{gd}	-	35.4	-		
*t _{d(ON)}	-	32.4	-	ns	V _{DS} =15V, I _D =20A, V _{GS} =10V, R _G =1Ω
*t _r	-	28.8	-		
*t _{d(OFF)}	-	108.8	-		
*t _f	-	24	-		
C _{iss}	-	6726	-	pF	V _{GS} =0V, V _{DS} =20V, f=1MHz
C _{oss}	-	1066	-		
C _{rss}	-	506	-		
R _g	-	1.0	-	Ω	f=1MHz
Source-Drain Diode					
*I _S	-	-	84	A	
*I _{SM}	-	-	450		
*V _{SD}	-	0.71	1.1	V	I _S =5A, V _{GS} =0V
*t _{rr}	-	40	-	ns	V _{GS} =0V, I _F =5A, dI _F /dt=100A/μs
*Q _{rr}	-	37.9	-	nC	

*Pulse Test : Pulse Width ≤300μs, Duty Cycle≤2%

Recommended Soldering Footprint & Stencil Design

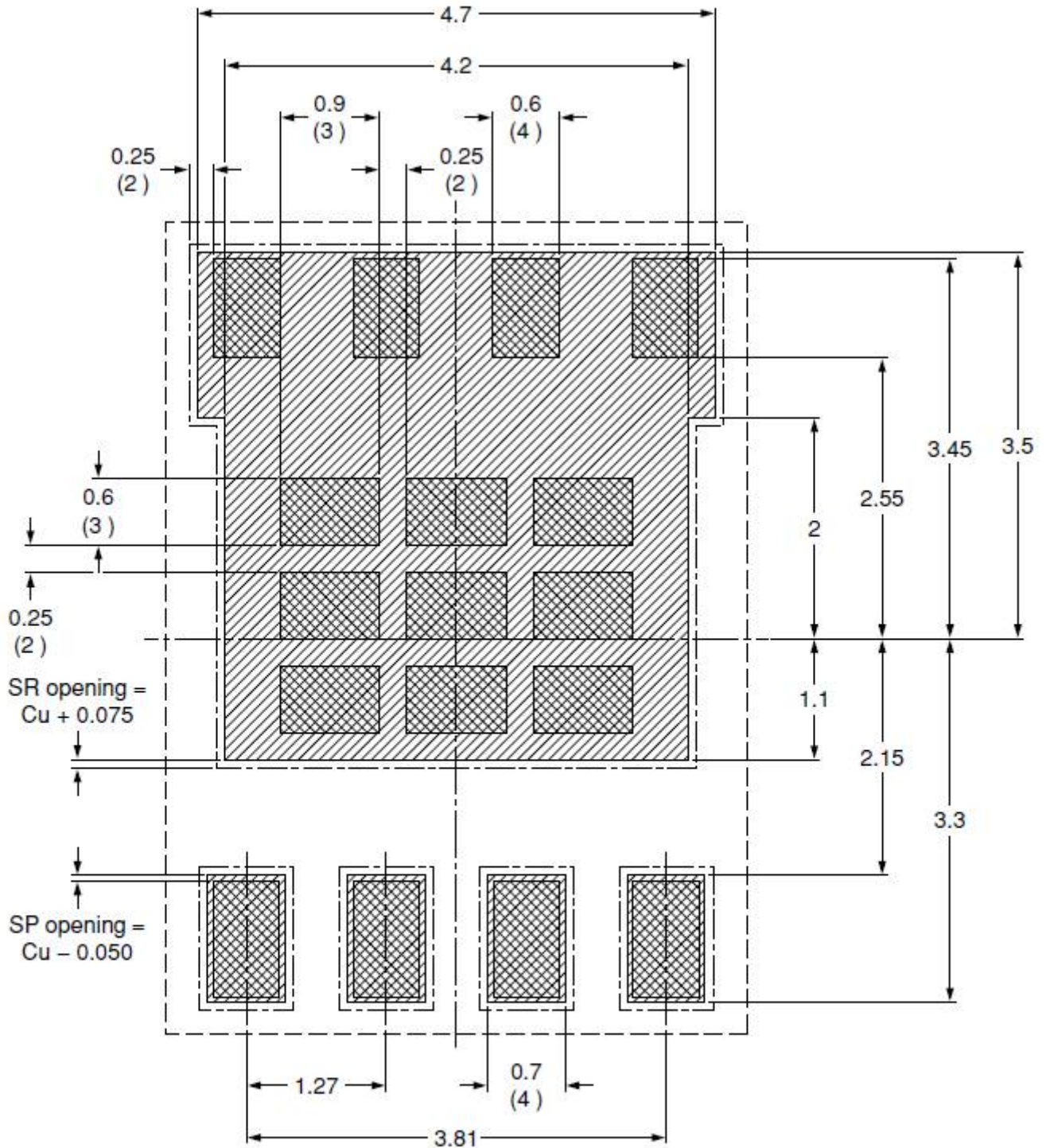

- | | |
|---|---|
|  solder lands |  solder paste
125 μ m stencil |
|  solder resist |  occupied area |

unit : mm

Typical Characteristics

Typical Output Characteristics

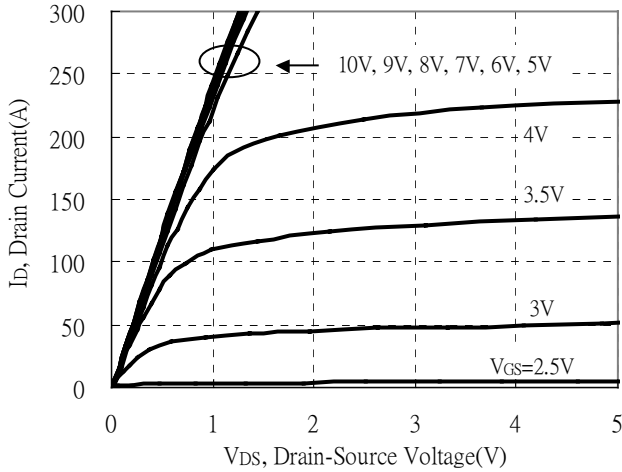

Brekdown Voltage vs Ambient Temperature

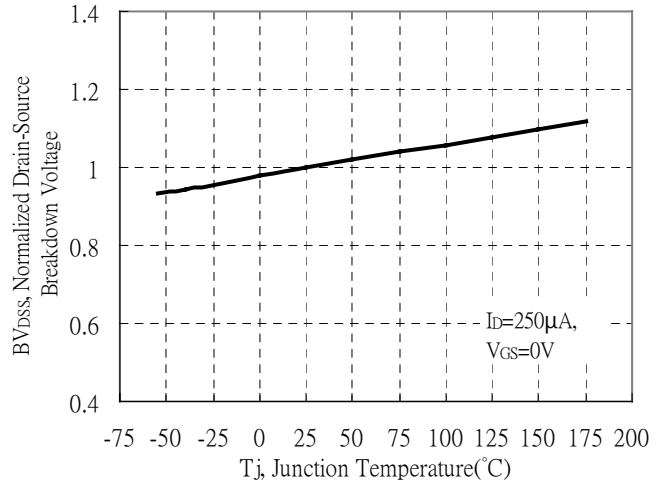

Static Drain-Source On-State resistance vs Drain Current

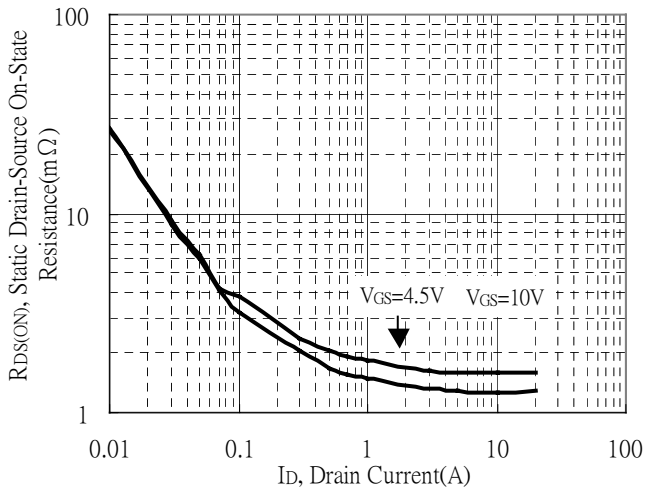

Reverse Drain Current vs Source-Drain Voltage

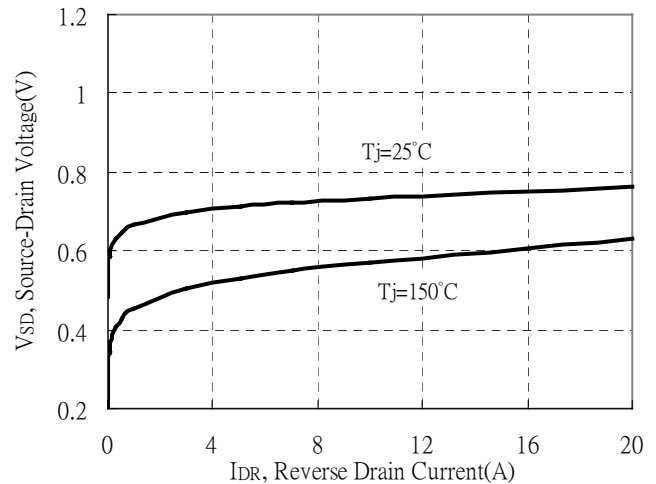

Static Drain-Source On-State Resistance vs Gate-Source Voltage

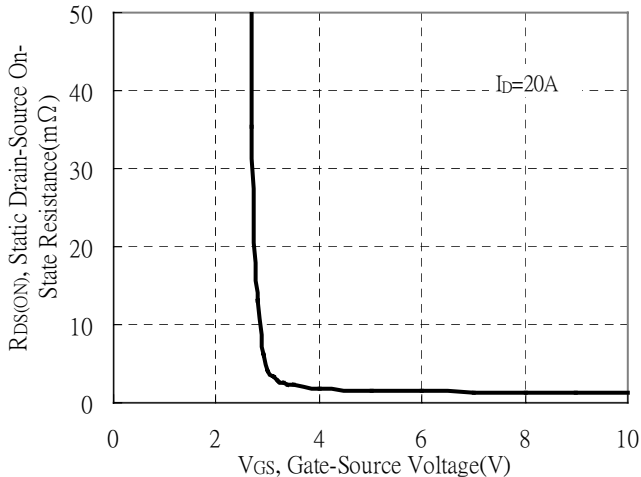

Drain-Source On-State Resistance vs Junction Temperature

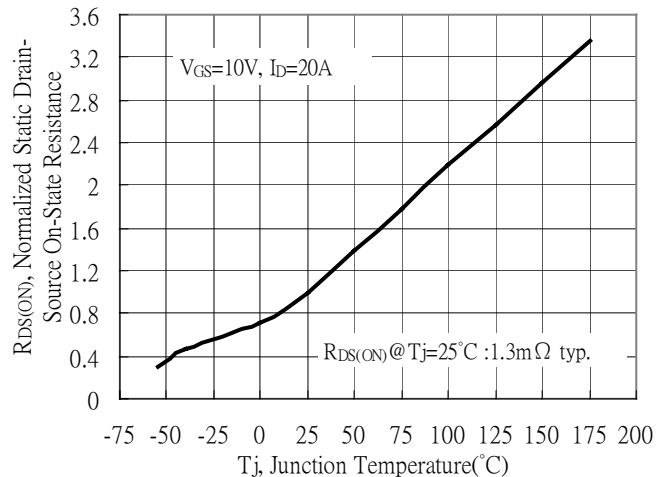

Typical Characteristics(Cont.)

Capacitance vs Drain-to-Source Voltage

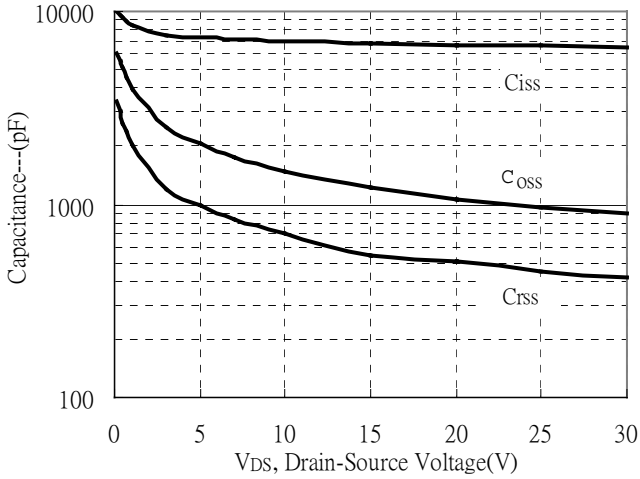

Threshold Voltage vs Junction Temperature

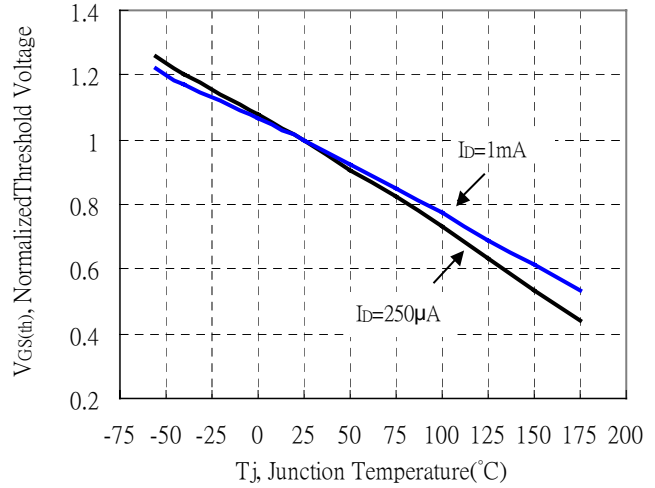

Forward Transfer Admittance vs Drain Current

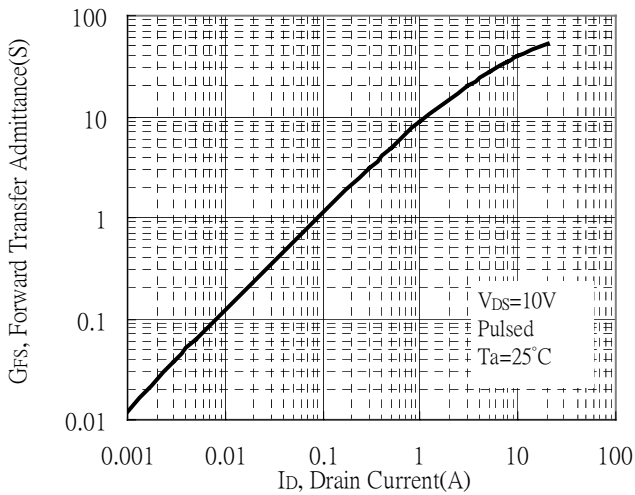

Gate Charge Characteristics

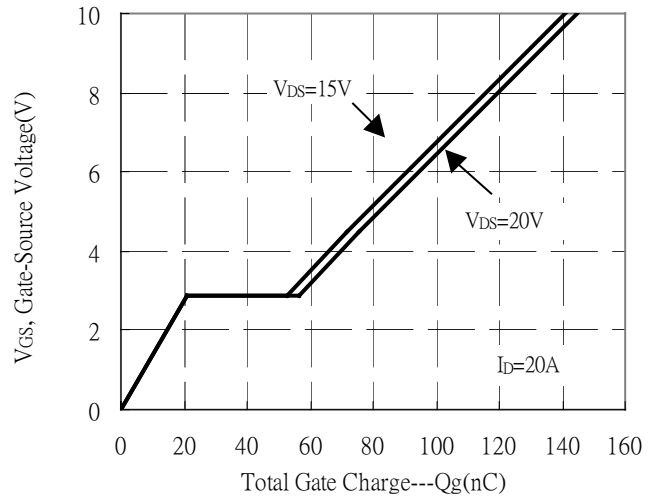

Maximum Safe Operating Area

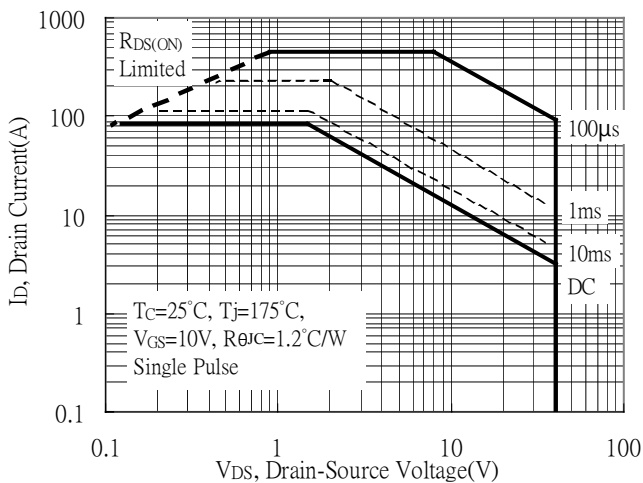

Maximum Drain Current vs Case Temperature

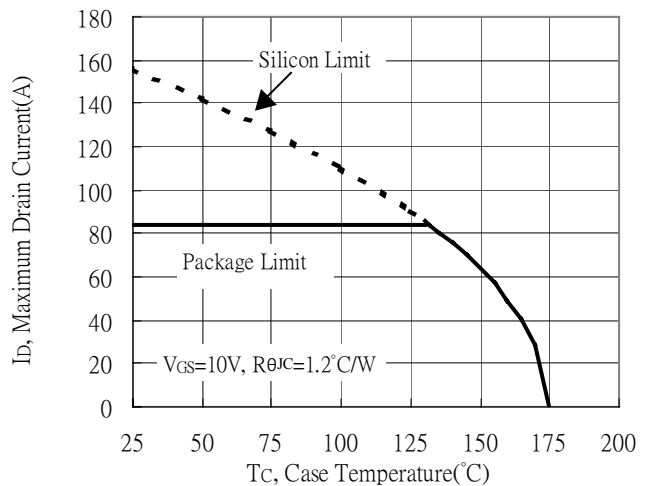

Typical Characteristics(Cont.)

Typical Transfer Characteristics

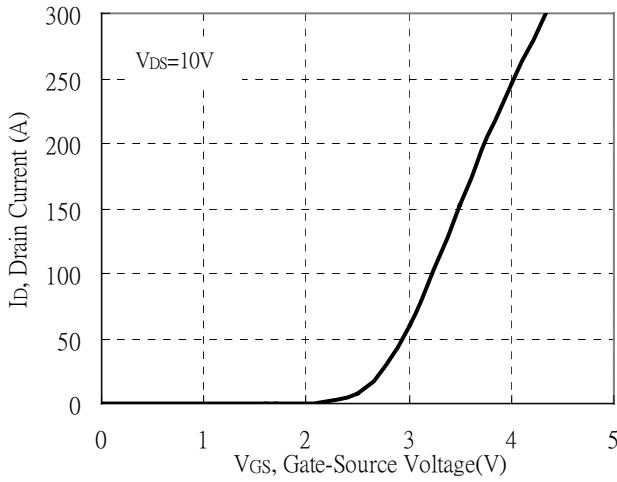

Single Pulse Maximum Power Dissipation

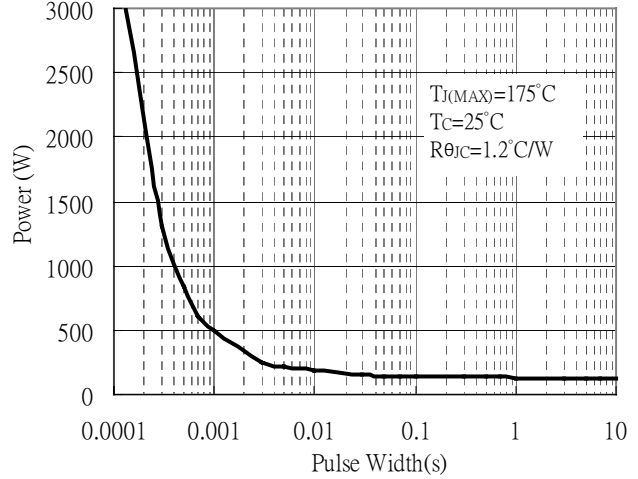

Transient Thermal Response Curves

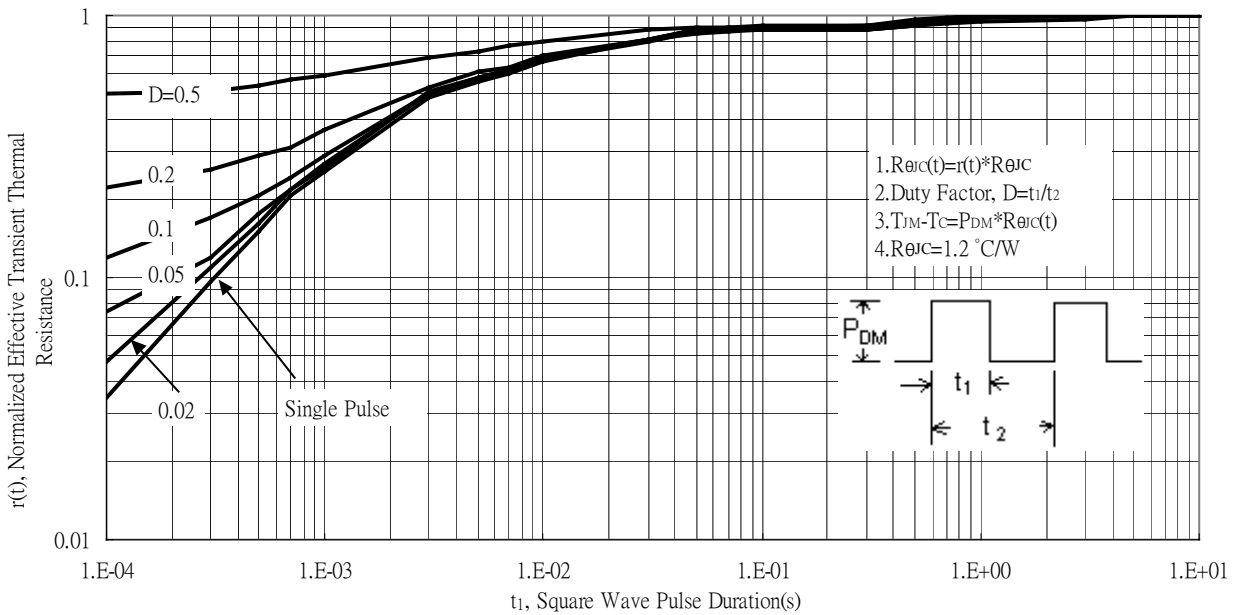

Reel Dimension

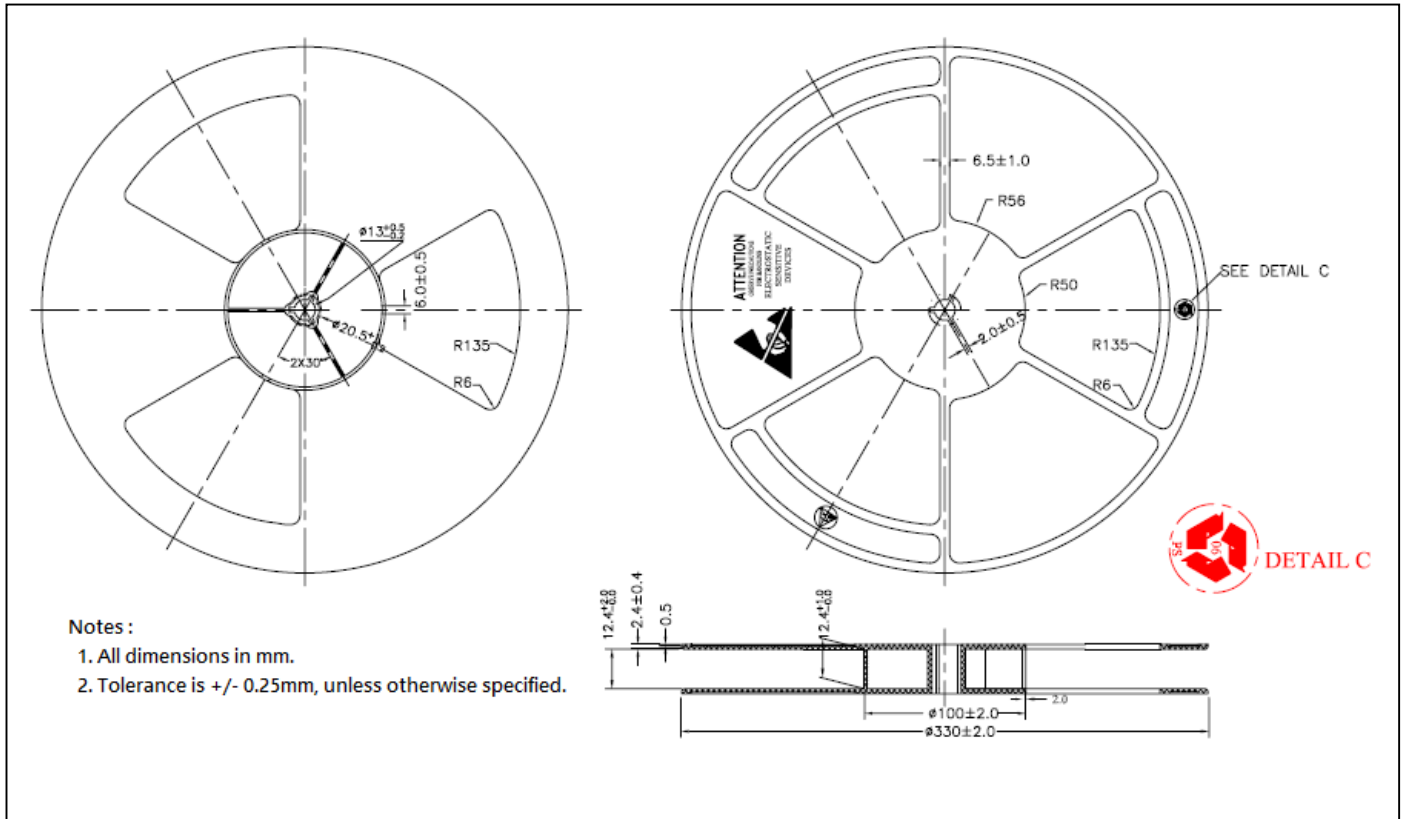

Carrier Tape Dimension

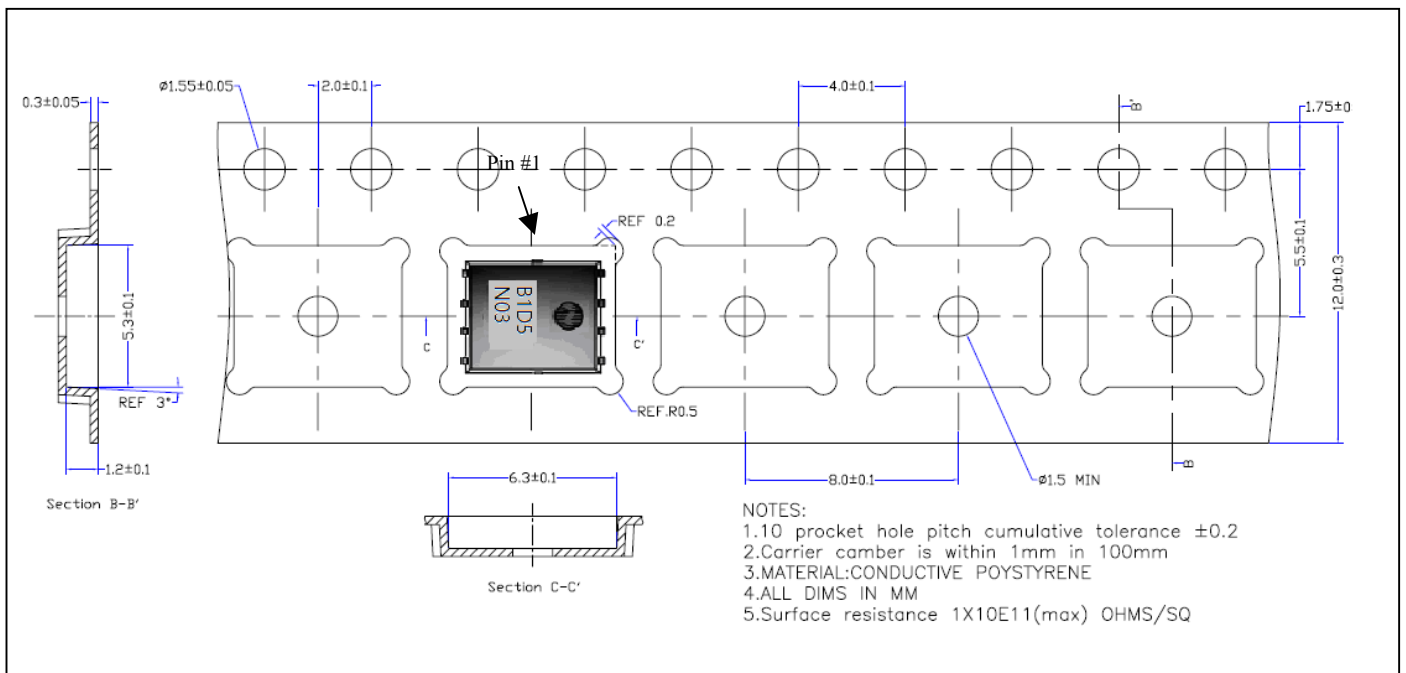

Recommended wave soldering condition

Product	Peak Temperature	Soldering Time
Pb-free devices	260 +0/-5 °C	5 +1/-1 seconds

Recommended temperature profile for IR reflow

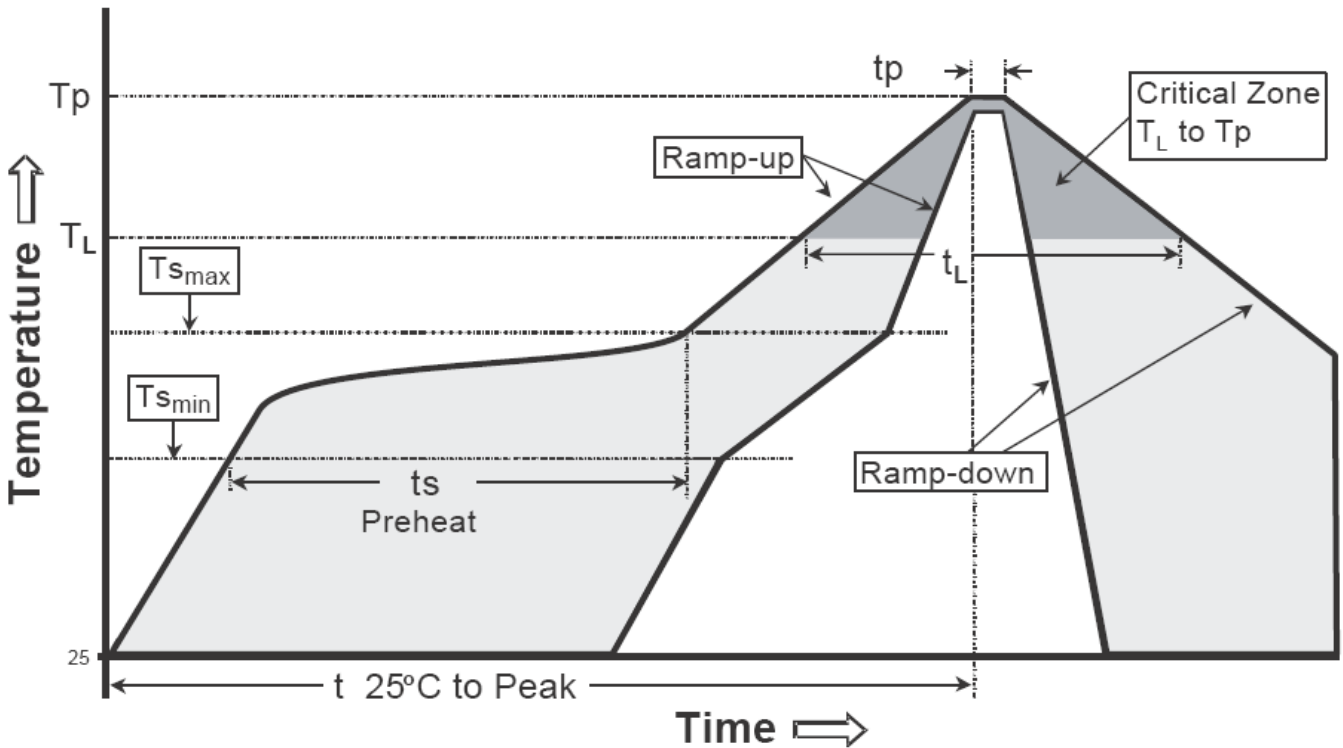

Profile feature	Sn-Pb eutectic Assembly	Pb-free Assembly
Average ramp-up rate (Tsmax to Tp)	3°C/second max.	3°C/second max.
Preheat		
-Temperature Min(Ts min)	100°C	150°C
-Temperature Max(Ts max)	150°C	200°C
-Time(ts min to ts max)	60-120 seconds	60-180 seconds
Time maintained above:		
-Temperature (TL)	183°C	217°C
- Time (tL)	60-150 seconds	60-150 seconds
Peak Temperature(TP)	240 +0/-5 °C	260 +0/-5 °C
Time within 5°C of actual peak temperature(tp)	10-30 seconds	20-40 seconds
Ramp down rate	6°C/second max.	6°C/second max.
Time 25 °C to peak temperature	6 minutes max.	8 minutes max.

Note : All temperatures refer to topside of the package, measured on the package body surface.

DFN5x6 Dimension

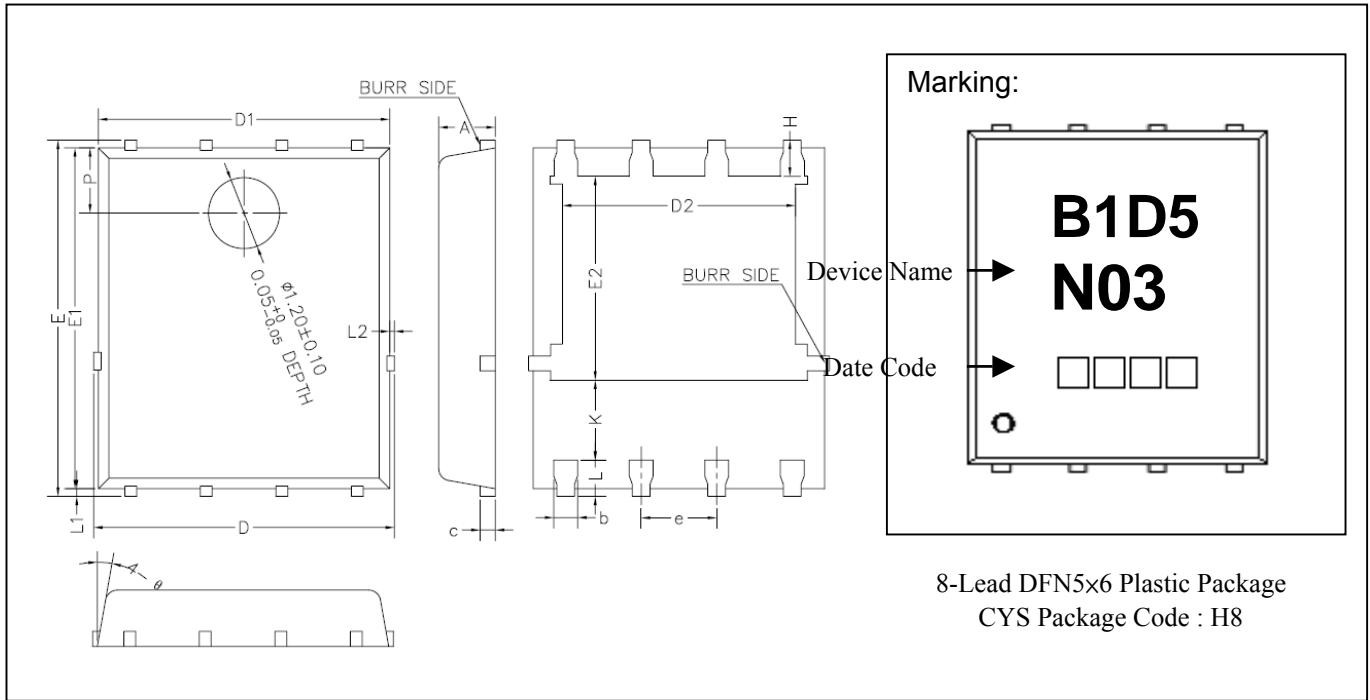

DIM	Millimeters		Inches		DIM	Millimeters		Inches	
	Min.	Max.	Min.	Max.		Min.	Max.	Min.	Max.
A	1.00	1.20	0.039	0.047	E2	3.18	3.54	0.125	0.139
b	0.35	0.45	0.014	0.018	H	0.51	0.71	0.020	0.028
c	0.21	0.34	0.008	0.013	K	1.10	-	0.043	-
D	-	5.10	-	0.201	L	0.51	0.71	0.020	0.028
D1	4.80	5.00	0.189	0.197	L1	0.06	0.20	0.002	0.008
D2	3.82	4.11	0.150	0.162	L2	-	0.10	-	0.004
e	1.17	1.37	0.046	0.054	p	1.00	1.20	0.039	0.047
E	5.90	6.10	0.232	0.240	θ	8°	12°	8°	12°
E1	5.70	5.80	0.224	0.228					

Notes: 1. Controlling dimension: millimeters.
 2. Maximum lead thickness includes lead finish thickness, and minimum lead thickness is the minimum thickness of base material.
 3. If there is any question with packing specification or packing method, please contact your local CYStek sales office.

Material:

- Lead: Pure tin plated.
- Mold Compound: Epoxy resin family, flammability solid burning class: UL94V-0.

Important Notice:

- All rights are reserved. Reproduction in whole or in part is prohibited without the prior written approval of CYStek.
- CYStek reserves the right to make changes to its products without notice.
- CYStek **semiconductor products are not warranted to be suitable for use in Life-Support Applications, or systems.**
- CYStek assumes no liability for any consequence of customer product design, infringement of patents, or application assistance.