

N -Channel Enhancement Mode Power MOSFET

MTB160N25J3

BV_{DSS}	250V	
$I_D@V_{GS}=10V, T_C=25^\circ C$	18A	
$R_{DS(on)(TYP)}$	$V_{GS}=10V, I_D=9A$	132m Ω
	$V_{GS}=4.5V, I_D=6A$	138m Ω

Features

- Low Gate Charge
- Simple Drive Requirement
- Pb-free lead plating package

Equivalent Circuit

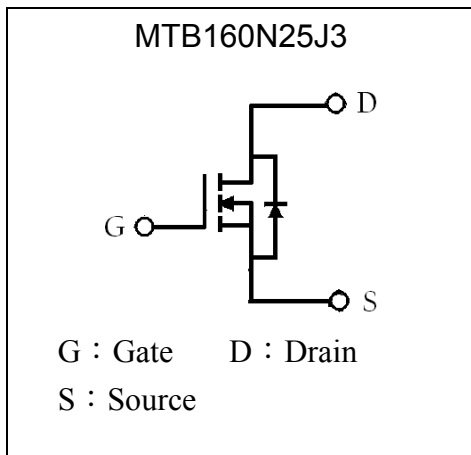

Outline

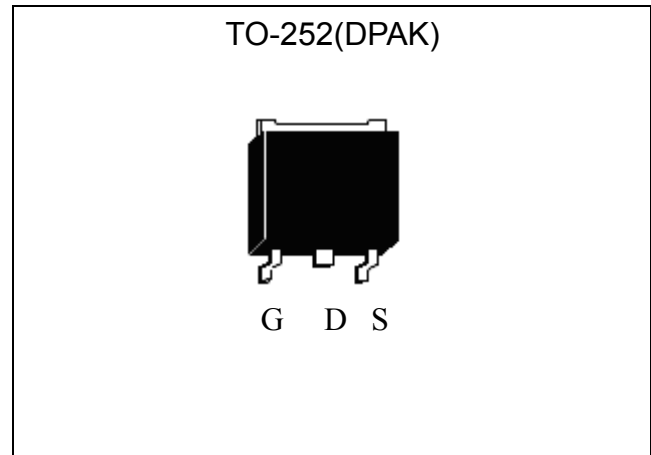

Ordering Information

Device	Package	Shipping
MTB160N25J3-0-T3-G	TO-252 (Pb-free lead plating and halogen-free package)	2500 pcs / Tape & Reel

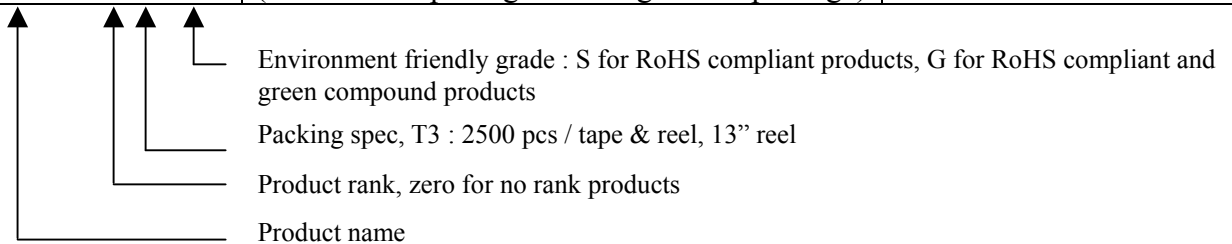



Absolute Maximum Ratings (Tc=25°C, unless otherwise noted)

Parameter	Symbol	Limits	Unit
Drain-Source Voltage	V _{DS}	250	V
Gate-Source Voltage	V _{GS}	±20	
Continuous Drain Current @ Tc=25°C, V _{GS} =10V	I _D	18	A
Continuous Drain Current @ Tc=100°C, V _{GS} =10V	I _D	12.7	
Pulsed Drain Current *1	I _{DM}	44	
Avalanche Current	I _{AS}	10	
Avalanche Energy @ L=6mH, I _D =8A, R _G =25 Ω	E _{AS}	192	mJ
Total Power Dissipation @Tc=25°C	P _d	83	W
Total Power Dissipation @Tc=100°C		41.5	
Operating Junction and Storage Temperature Range	T _j , T _{stg}	-55~+175	°C

Note : *1. Pulse width limited by maximum junction temperature
 *2. Duty cycle ≤ 1%

Thermal Data

Parameter	Symbol	Value	Unit
Thermal Resistance, Junction-to-case, max	R _{th,j-c}	1.8	°C/W
Thermal Resistance, Junction-to-ambient, max	R _{th,j-a}	62.5	°C/W

Characteristics (Tc=25°C, unless otherwise specified)

Symbol	Min.	Typ.	Max.	Unit	Test Conditions
Static					
BV _{DSS}	250	-	-	V	V _{GS} =0V, I _D =250μA
V _{GS(th)}	1	-	2.5	V	V _{DS} =V _{GS} , I _D =250μA
I _{GSS}	-	-	±100	nA	V _{GS} =±20V, V _{DS} =0V
I _{DSS}	-	-	1	μA	V _{DS} =250V, V _{GS} =0V
	-	-	10		V _{DS} =200V, V _{GS} =0V, T _J =125°C
R _{DS(ON)} *1	-	132	175	mΩ	V _{GS} =10V, I _D =9A
	-	138	195		V _{GS} =4.5V, I _D =6A
G _{FS} *1	-	22	-	S	V _{DS} =10V, I _D =9A
Dynamic					
Q _g *1, 2	-	44.3	-	nC	V _{DS} =200V, I _D =18A, V _{GS} =10V
Q _{gs} *1, 2	-	6.3	-		
Q _{gd} *1, 2	-	15	-		
t _{d(ON)} *1, 2	-	16	-	ns	V _{DS} =125V, I _D =18A, V _{GS} =10V, R _G =25 Ω
t _r *1, 2	-	55	-		
t _{d(OFF)} *1, 2	-	141	-		
t _f *1, 2	-	125	-		
C _{iss}	-	2170	-	pF	V _{GS} =0V, V _{DS} =25V, f=1MHz
C _{oss}	-	121	-		
C _{rss}	-	73	-		
R _g	-	1.4	-	Ω	f=1MHz

Source-Drain Diode					
I_S *1	-	-	18	A	
I_{SM} *3	-	-	44		
V_{SD} *1	-	0.84	1.3	V	$I_F=18A, V_{GS}=0V$
trr	-	117	-	ns	$I_F=18A, dI_F/dt=100A/\mu s$
Qrr	-	480	-	nC	

Note : *1.Pulse Test : Pulse Width $\leq 300\mu s$, Duty Cycle $\leq 2\%$
 *2.Independent of operating temperature
 *3.Pulse width limited by maximum junction temperature.

Recommended soldering footprint

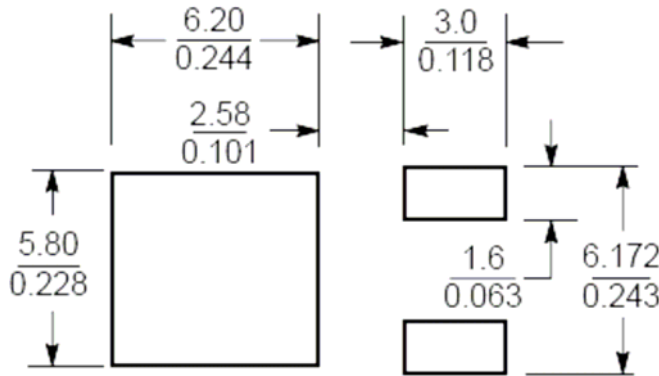

Unit ($\frac{mm}{inch}$)

Typical Characteristics

Typical Output Characteristics

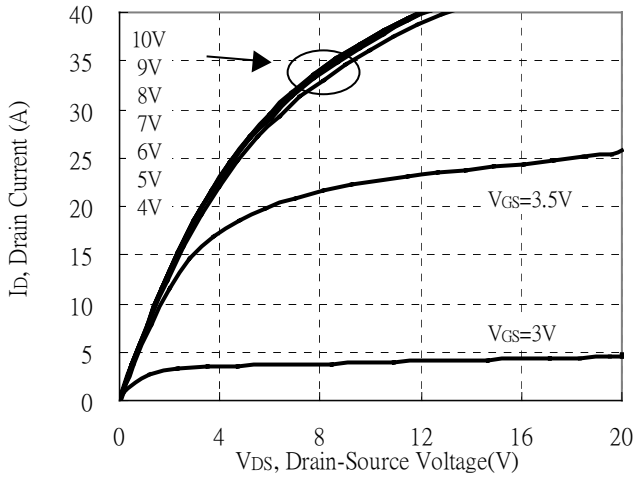

Brekdown Voltage vs Ambient Temperature

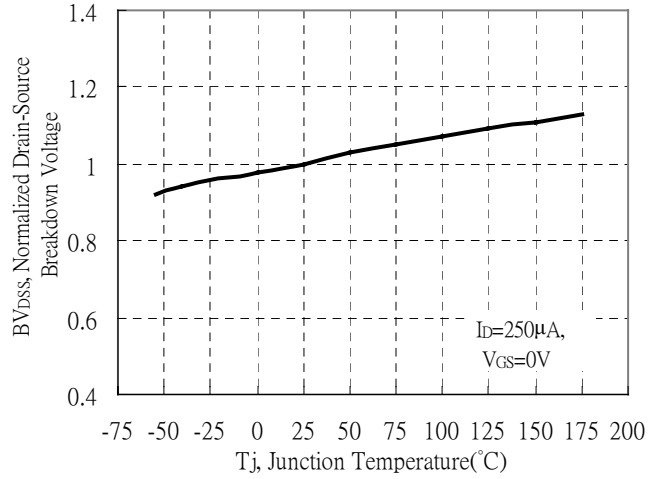

Static Drain-Source On-State resistance vs Drain Current

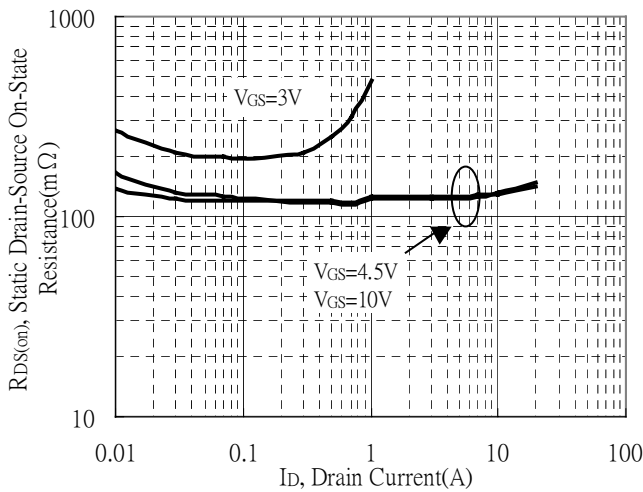

Reverse Drain Current vs Source-Drain Voltage

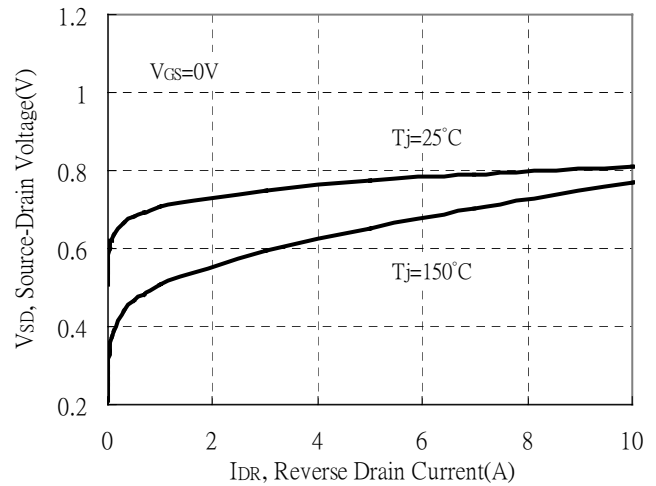

Static Drain-Source On-State Resistance vs Gate-Source Voltage

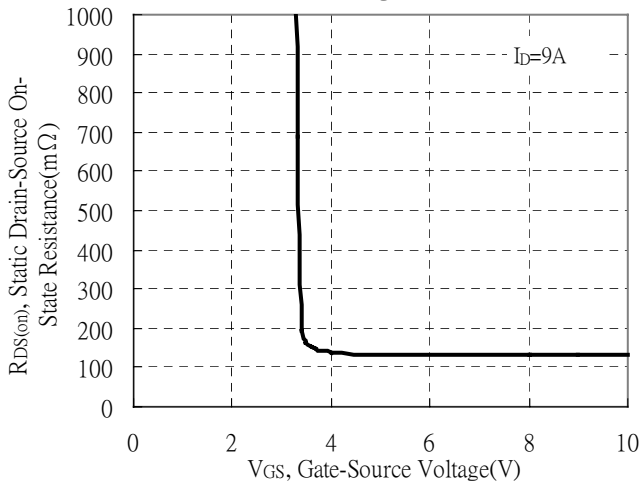

Drain-Source On-State Resistance vs Junction Temperature

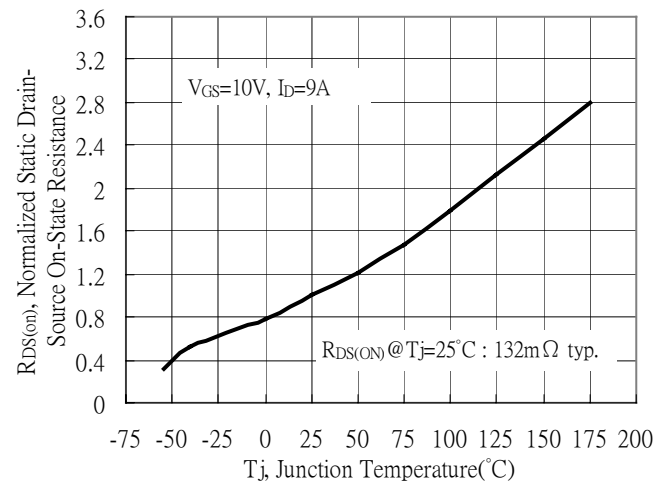



Typical Characteristics(Cont.)

Capacitance vs Drain-to-Source Voltage

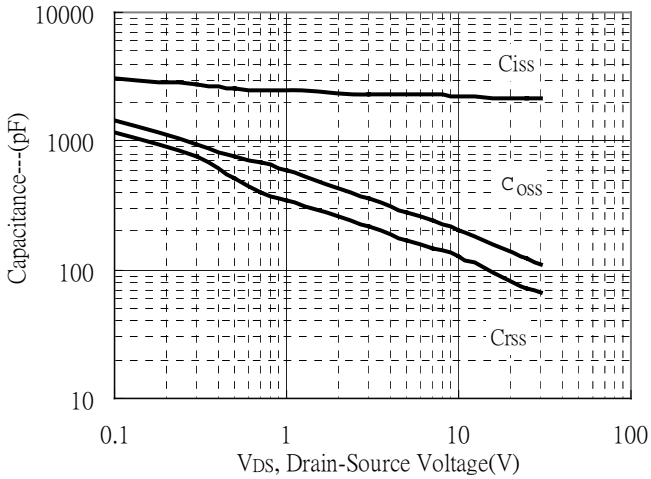

Threshold Voltage vs Junction Temperature

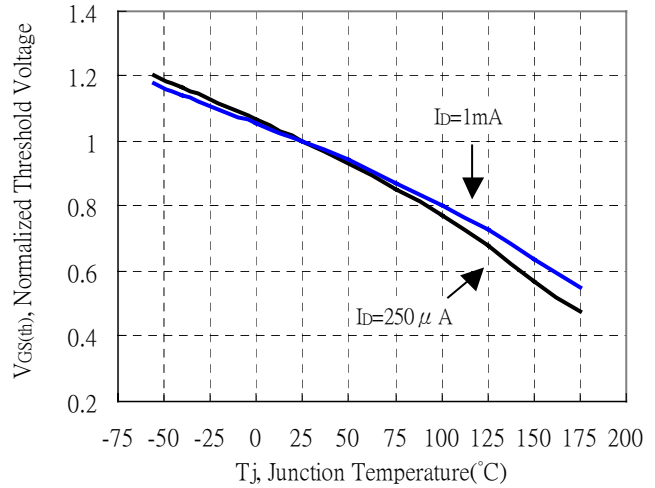

Forward Transfer Admittance vs Drain Current

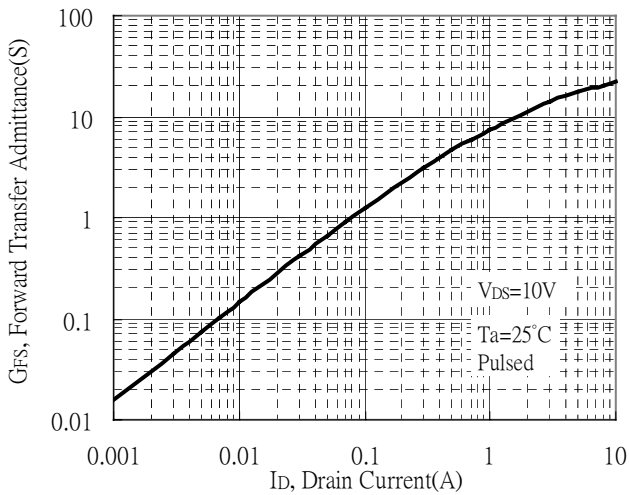

Gate Charge Characteristics

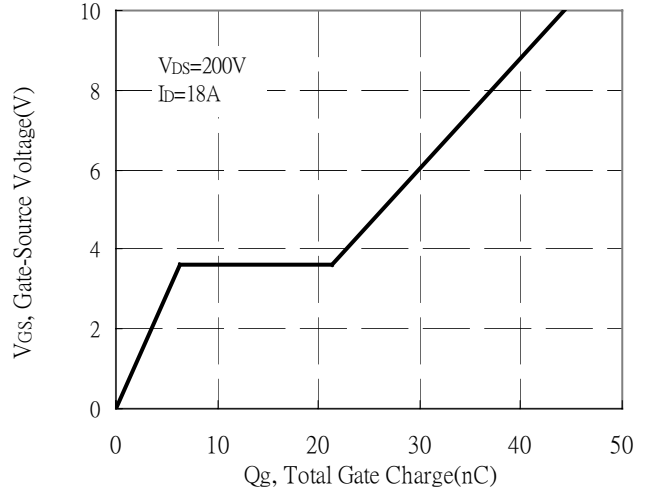

Maximum Safe Operating Area

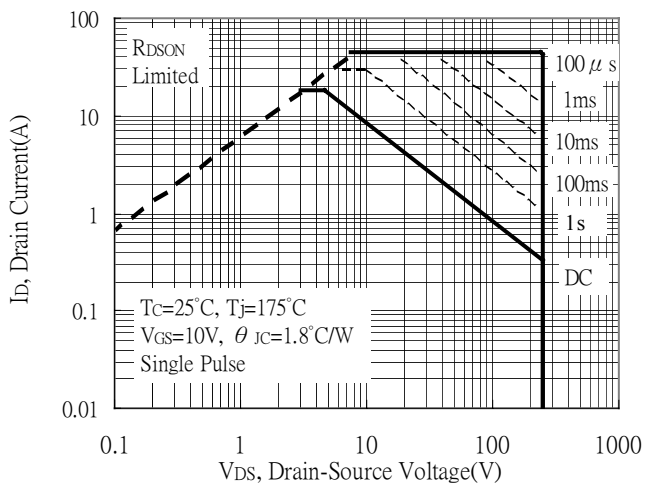

Maximum Drain Current vs Case Temperature

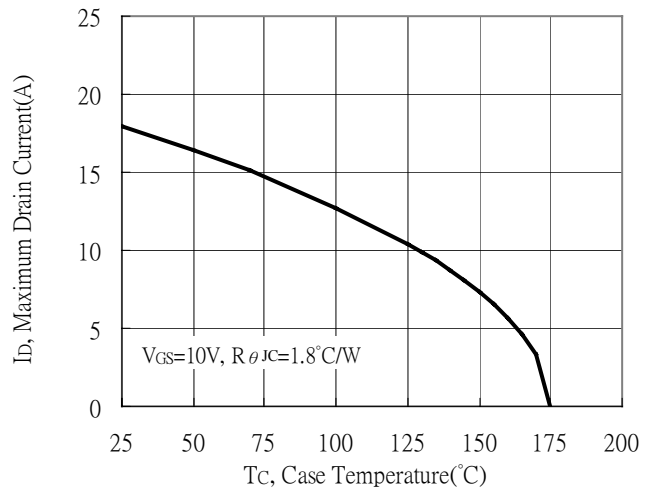

Typical Characteristics(Cont.)

Typical Transfer Characteristics

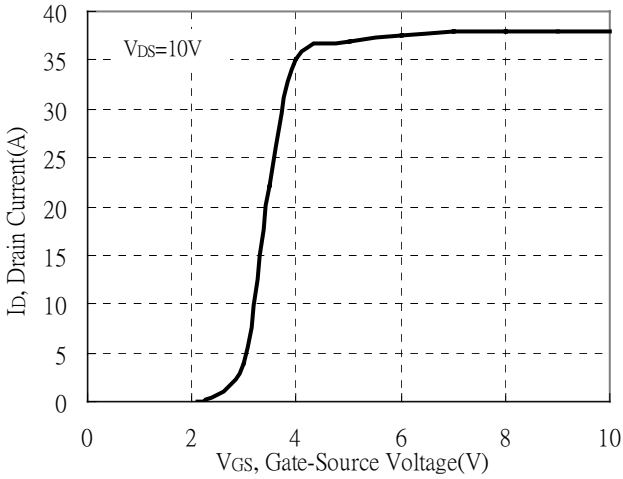

Single Pulse Power Rating, Junction to Case

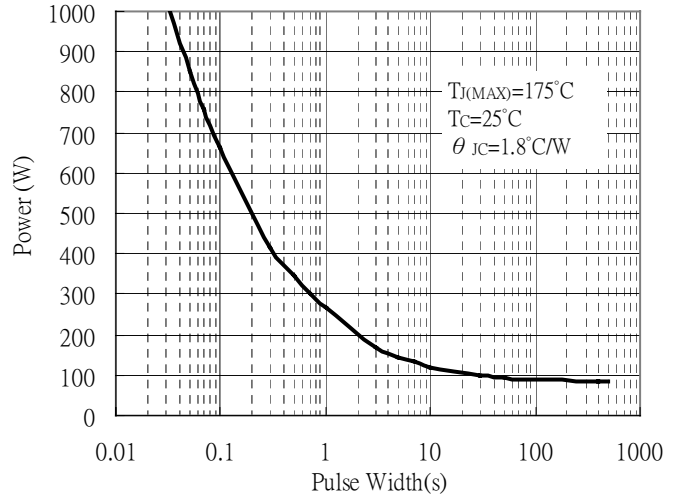

Transient Thermal Response Curves

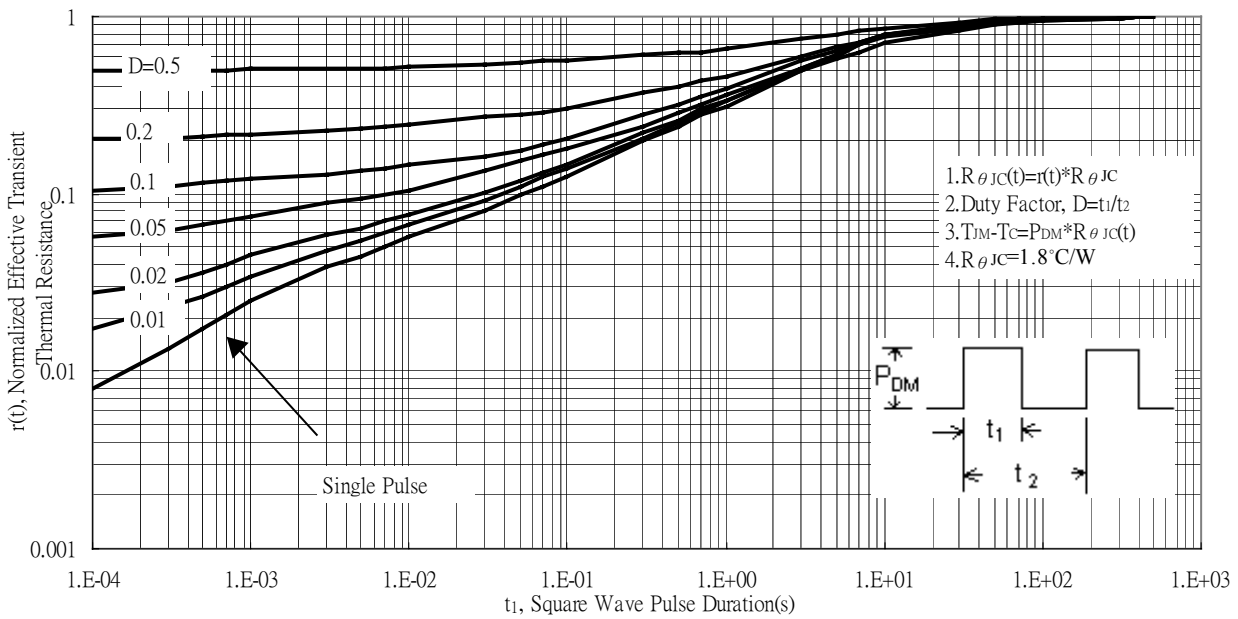

Recommended wave soldering condition

Product	Peak Temperature	Soldering Time
Pb-free devices	260 +0/-5 °C	5 +1/-1 seconds

Recommended temperature profile for IR reflow

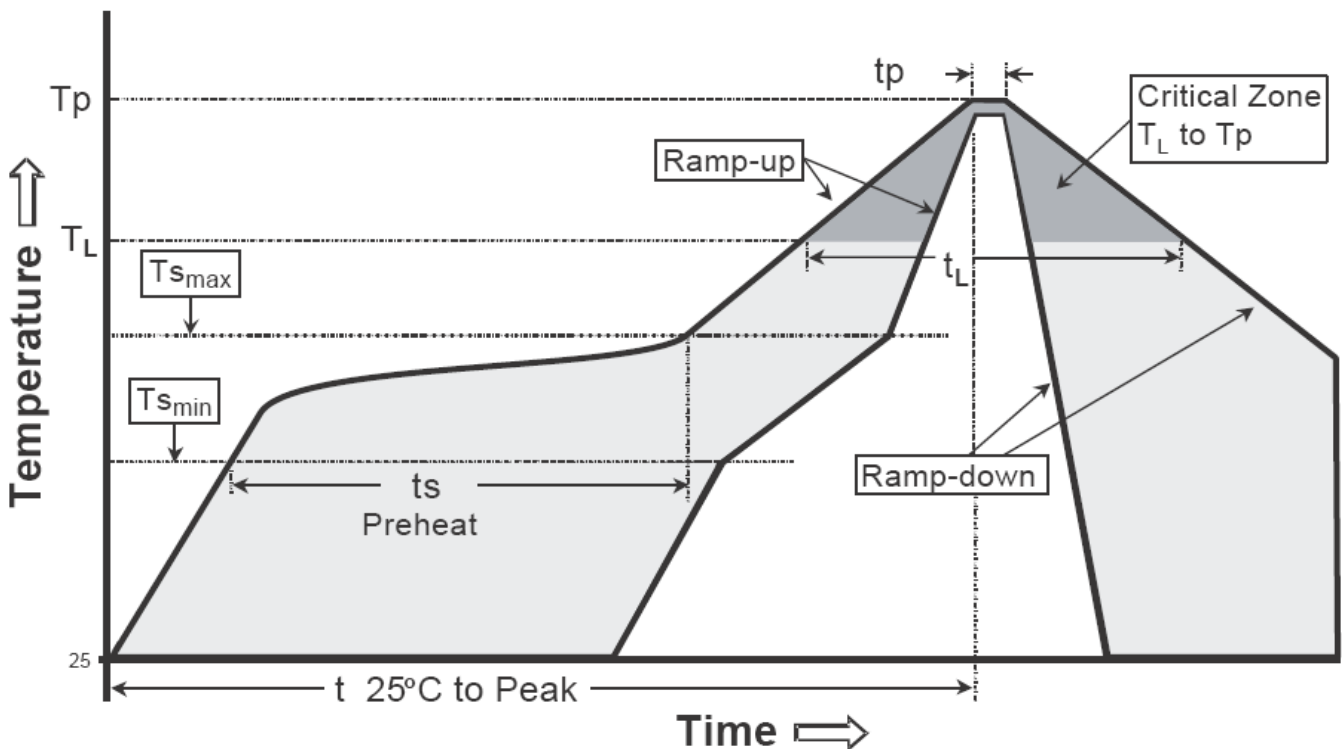

Profile feature	Sn-Pb eutectic Assembly	Pb-free Assembly
Average ramp-up rate (T _{smax} to T _p)	3°C/second max.	3°C/second max.
Preheat		
-Temperature Min(T _{s min})	100°C	150°C
-Temperature Max(T _{s max})	150°C	200°C
-Time(t _{s min} to t _{s max})	60-120 seconds	60-180 seconds
Time maintained above:		
-Temperature (T _L)	183°C	217°C
- Time (t _L)	60-150 seconds	60-150 seconds
Peak Temperature(T _P)	240 +0/-5 °C	260 +0/-5 °C
Time within 5°C of actual peak temperature(tp)	10-30 seconds	20-40 seconds
Ramp down rate	6°C/second max.	6°C/second max.
Time 25 °C to peak temperature	6 minutes max.	8 minutes max.

Note : All temperatures refer to topside of the package, measured on the package body surface.

TO-252 Dimension

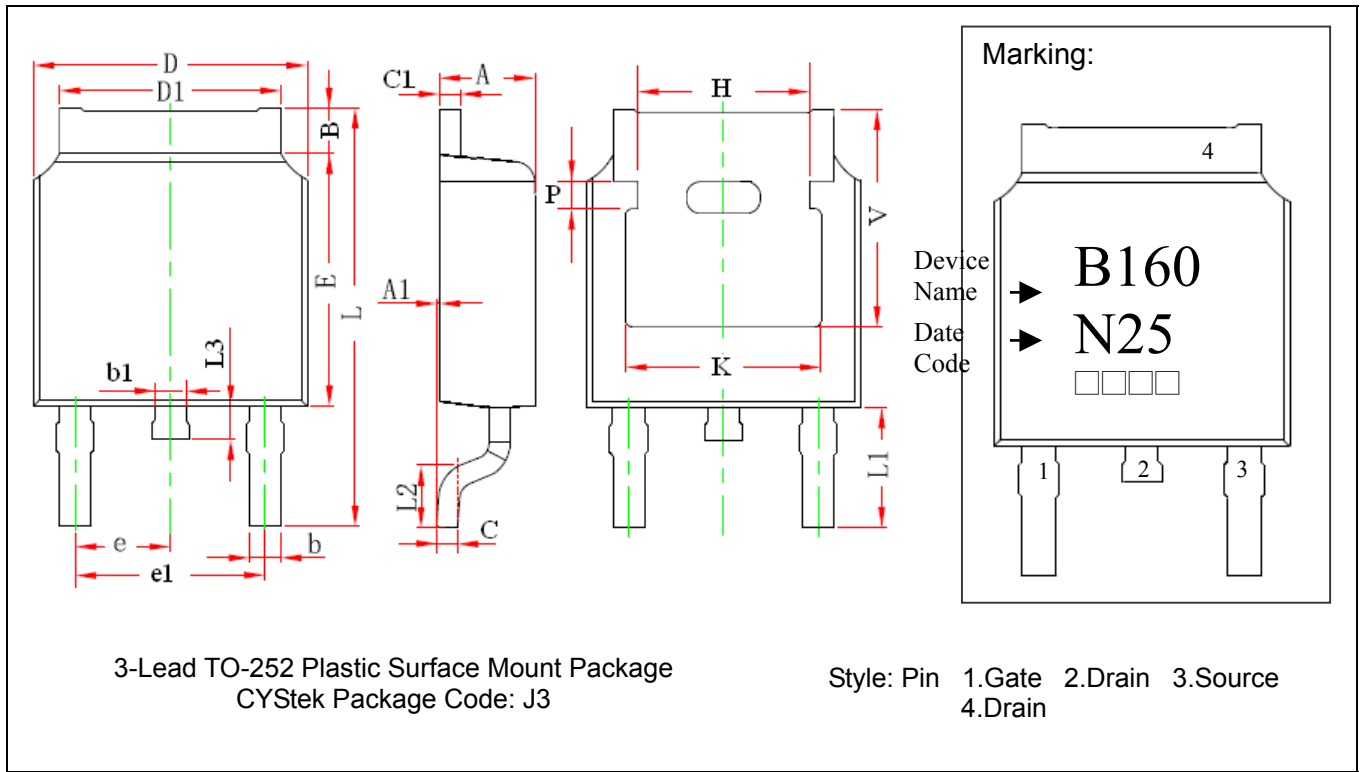

DIM	Inches		Millimeters		DIM	Inches		Millimeters	
	Min.	Max.	Min.	Max.		Min.	Max.	Min.	Max.
A	0.087	0.094	2.200	2.400	e	0.086	0.094	2.186	2.386
A1	0.000	0.005	0.000	0.127	e1	0.172	0.188	4.372	4.772
B	0.039	0.048	0.990	1.210	H	0.163	REF	4.140	REF
b	0.026	0.034	0.660	0.860	K	0.190	REF	4.830	REF
b1	0.026	0.034	0.660	0.860	L	0.386	0.409	9.800	10.400
C	0.018	0.023	0.460	0.580	L1	0.114	REF	2.900	REF
C1	0.018	0.023	0.460	0.580	L2	0.055	0.067	1.400	1.700
D	0.256	0.264	6.500	6.700	L3	0.024	0.039	0.600	1.000
D1	0.201	0.215	5.100	5.460	P	0.026	REF	0.650	REF
E	0.236	0.244	6.000	6.200	V	0.211	REF	5.350	REF

Notes: 1.Controlling dimension: millimeters.
 2.Maximum lead thickness includes lead finish thickness, and minimum lead thickness is the minimum thickness of base material.
 3.If there is any question with packing specification or packing method, please contact your local CYStek sales office.

Material:

- Lead : Pure tin plated.
- Mold Compound: Epoxy resin family, flammability solid burning class: UL94V-0.

Important Notice:

- All rights are reserved. Reproduction in whole or in part is prohibited without the prior written approval of CYStek.
- CYStek reserves the right to make changes to its products without notice.
- CYStek **semiconductor products are not warranted to be suitable for use in Life-Support Applications, or systems.**
- CYStek assumes no liability for any consequence of customer product design, infringement of patents, or application assistance.