

**N-Channel Logic Level Enhancement Mode Power MOSFET**

# MTB12N03J3

|                                   |               |
|-----------------------------------|---------------|
| $BV_{DSS}$                        | 30V           |
| $I_D$                             | 40A           |
| $R_{DS(on)}@V_{GS}=10V, I_D=15A$  | 8.5mΩ (typ.)  |
| $R_{DS(on)}@V_{GS}=4.5V, I_D=10A$ | 13.5mΩ (typ.) |

**Features**

- Single Drive Requirement
- Low On-resistance
- Fast Switching Characteristic
- Dynamic dv/dt rating
- Repetitive Avalanche Rated
- Pb-free Lead Plating and Halogen-free package

**Symbol**

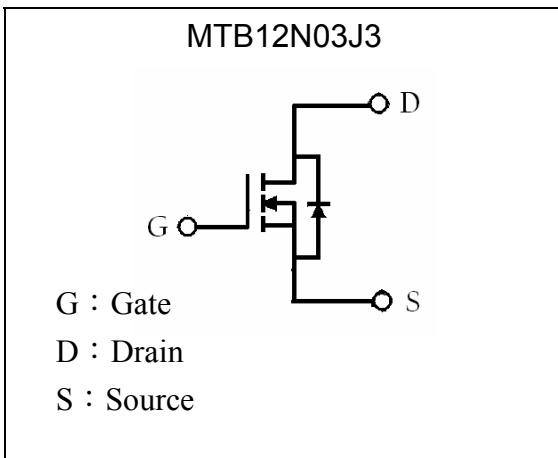

**Outline**

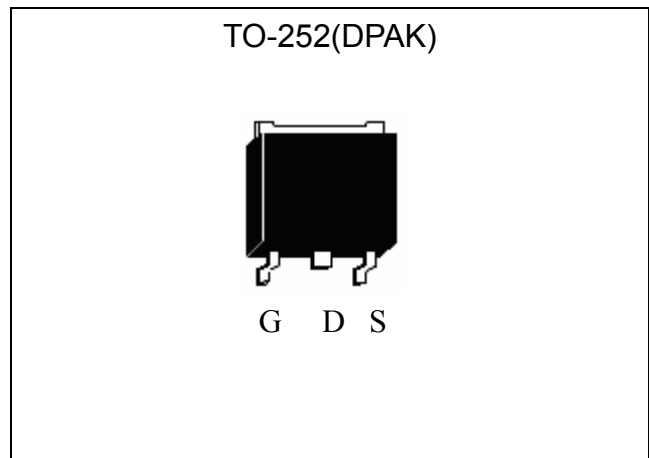

**Ordering Information**

| Device            | Package   | Shipping               |
|-------------------|---|------------------------|
| MTB12N03J3-0-T3-G | TO-252<br>(Pb-free lead plating & halogen-free package) | 2500 pcs / Tape & Reel |

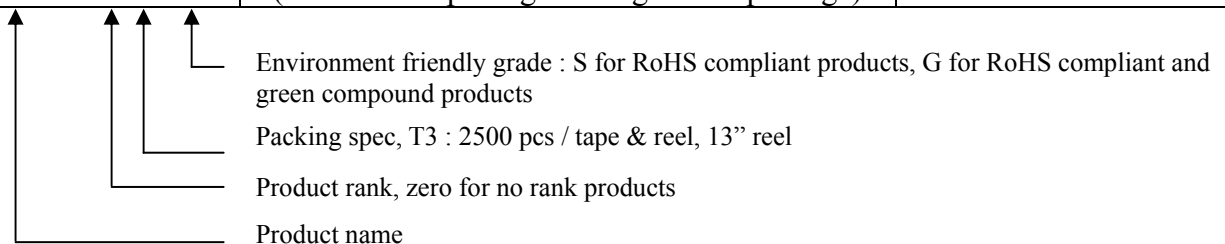



**Absolute Maximum Ratings (Ta=25°C)**

| Parameter  | Symbol                            | Limits                | Unit |   |
|--|-----------------------------------|-----------------------|------|---|
| Drain-Source Voltage   | V <sub>DS</sub>                   | 30                    | V    |   |
| Gate-Source Voltage  | V <sub>GS</sub>                   | ±20                   |      |   |
| Continuous Drain Current @ T <sub>c</sub> =25°C                      | I <sub>D</sub>                    | 40                    | A    |   |
| Continuous Drain Current @ T <sub>c</sub> =100°C                     |                                   | 25                    |      |   |
| Pulsed Drain Current   | I <sub>DM</sub>                   | 120 *1                |      |   |
| Avalanche Current  | I <sub>AS</sub>                   | 30                    |      |   |
| Avalanche Energy @ L=0.1mH, I <sub>D</sub> =30A, R <sub>G</sub> =25Ω | E <sub>AS</sub>                   | 45                    | mJ   |   |
| Repetitive Avalanche Energy @ L=0.05mH                               | E <sub>AR</sub>                   | 4.5 *2                |      |   |
| Total Power Dissipation  | P <sub>D</sub>                    | T <sub>c</sub> =25°C  | 35   | W |
|  |                                   | T <sub>c</sub> =100°C | 14   |   |
| Operating Junction and Storage Temperature Range                     | T <sub>j</sub> , T <sub>stg</sub> | -55~+150              | °C   |   |

**Thermal Data**

| Parameter                                    | Symbol              | Value | Unit |
|--|---------------------|-------|------|
| Thermal Resistance, Junction-to-case, max    | R <sub>th,j-c</sub> | 3.5   | °C/W |
| Thermal Resistance, Junction-to-ambient, max | R <sub>th,j-a</sub> | 50 *3 | °C/W |
| Thermal Resistance, Junction-to-ambient, max | R <sub>th,j-a</sub> | 110   | °C/W |

- Note : 1. Pulse width limited by maximum junction temperature  
 2. Duty cycle≤1%  
 3. When mounted on the minimum pad size recommended (PCB mount).

**Characteristics (Tc=25°C, unless otherwise specified)**

| Symbol                 | Min. | Typ. | Max. | Unit | Test Conditions   |
|------------------------|------|------|------|------|---|
| <b>Static</b>          |      |      |      |      |   |
| BV <sub>DSS</sub>      | 30   | -    | -    | V    | V <sub>GS</sub> =0, I <sub>D</sub> =250μA                       |
| V <sub>GS(th)</sub>    | 1    | 1.7  | 3    | V    | V <sub>DS</sub> = V <sub>GS</sub> , I <sub>D</sub> =250μA       |
| G <sub>FS</sub> *1     | -    | 14   | -    | S    | V <sub>DS</sub> =5V, I <sub>D</sub> =15A                        |
| I <sub>GSS</sub>       | -    | -    | ±100 | nA   | V <sub>GS</sub> =±20  |
| I <sub>DSS</sub>       | -    | -    | 1    | μA   | V <sub>DS</sub> =24V, V <sub>GS</sub> =0                        |
|                        | -    | -    | 25   |      | V <sub>DS</sub> =24V, V <sub>GS</sub> =0, T <sub>J</sub> =125°C |
| R <sub>DS(ON)</sub> *1 | -    | 8.5  | 11.5 | mΩ   | V <sub>GS</sub> =10V, I <sub>D</sub> =15A                       |
|                        | -    | 13.5 | 20   | mΩ   | V <sub>GS</sub> =4.5V, I <sub>D</sub> =10A                      |
| <b>Dynamic</b>         |      |      |      |      |   |
| C <sub>iss</sub>       | -    | 1195 | -    | pF   | V <sub>GS</sub> =0V, V <sub>DS</sub> =15V, f=1MHz               |
| C <sub>oss</sub>       | -    | 123  | -    |      |   |
| C <sub>rss</sub>       | -    | 101  | -    |      |   |

**Characteristics (Tc=25°C, unless otherwise specified)**

| Symbol                    | Min. | Typ. | Max. | Unit | Test Conditions                      |
|---------------------------|------|------|------|------|--------------------------------------|
| Qg (VGS=10V) *1, 2        | -    | 12   | -    | nC   | VDS=15V, VGS=10V, ID=15A             |
| Qg (VGS=4.5V) *1, 2       | -    | 6.2  | -    |      |                                      |
| Qgs *1, 2                 | -    | 1.2  | -    |      |                                      |
| Qgd *1, 2                 | -    | 3.7  | -    |      |                                      |
| td(ON) *1, 2              | -    | 8    | -    | ns   | VDS=15V, ID=1A, VGS=10V,<br>RGS=2.7Ω |
| tr *1, 2                  | -    | 6    | -    |      |                                      |
| td(OFF) *1, 2             | -    | 24   | -    |      |                                      |
| tf *1, 2                  | -    | 3    | -    |      |                                      |
| Rg                        | -    | 2    | -    | Ω    | VGS=15mV, VDS=0V, f=1MHz             |
| <b>Source-Drain Diode</b> |      |      |      |      |                                      |
| IS *1                     | -    | -    | 25   | A    |                                      |
| ISM *3                    | -    | -    | 100  |      |                                      |
| VSD *1                    | -    | -    | 1.3  | V    | IF=IS, VGS=0V                        |
| trr                       | -    | 18   | -    | ns   | IF=IS, dIF/dt=100A/μs                |
| Qrr                       | -    | 10   | -    | nC   |                                      |

Note : \*1.Pulse Test : Pulse Width ≤300μs, Duty Cycle≤2%  
 \*2.Independent of operating temperature  
 \*3.Pulse width limited by maximum junction temperature.

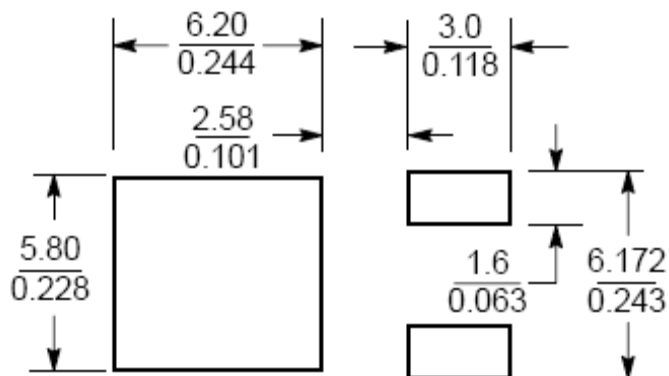
**Recommended soldering footprint**

 Unit (  $\frac{\text{mm}}{\text{inch}}$  )

**Typical Characteristics**

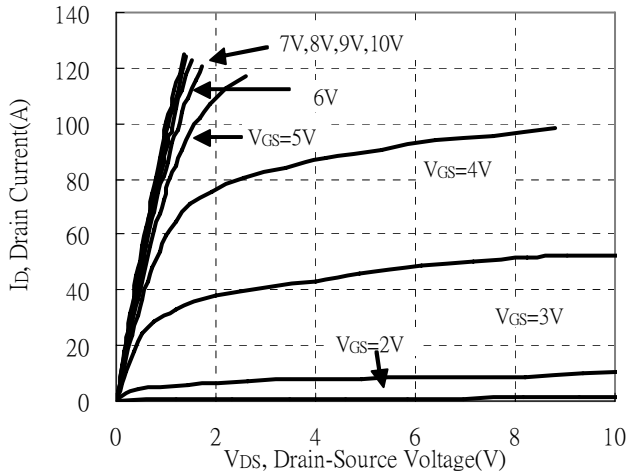
Typical Output Characteristics

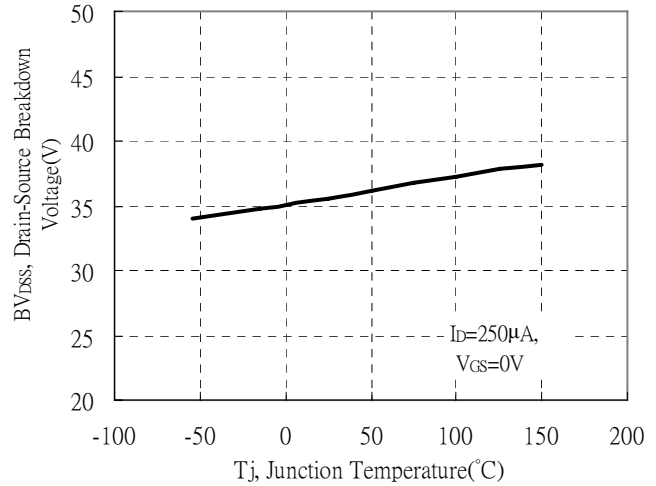

Breakdown Voltage vs Ambient Temperature



Static Drain-Source On-State resistance vs Drain Current

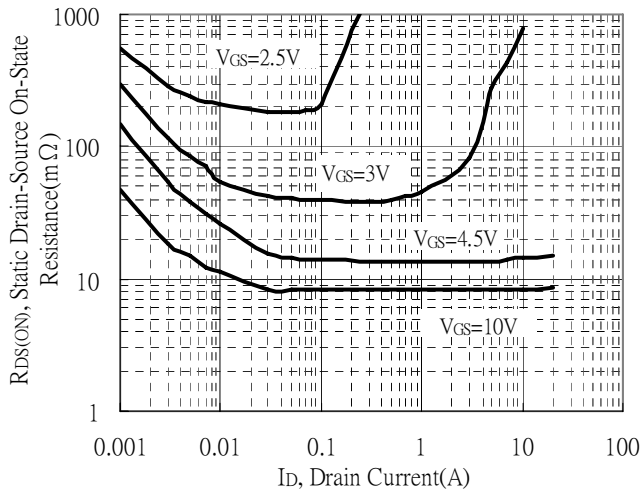

Reverse Drain Current vs Source-Drain Voltage

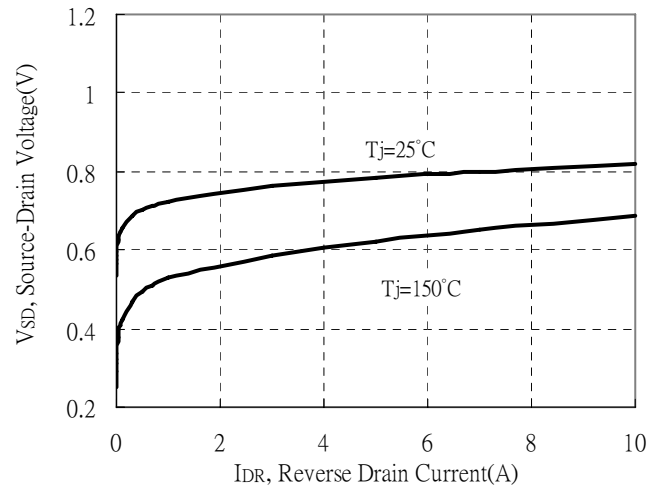

Static Drain-Source On-State Resistance vs Gate-Source Voltage

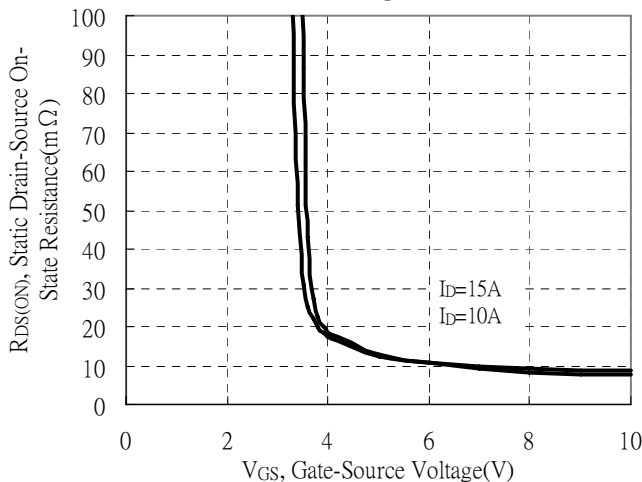

Drain-Source On-State Resistance vs Junction Temperature

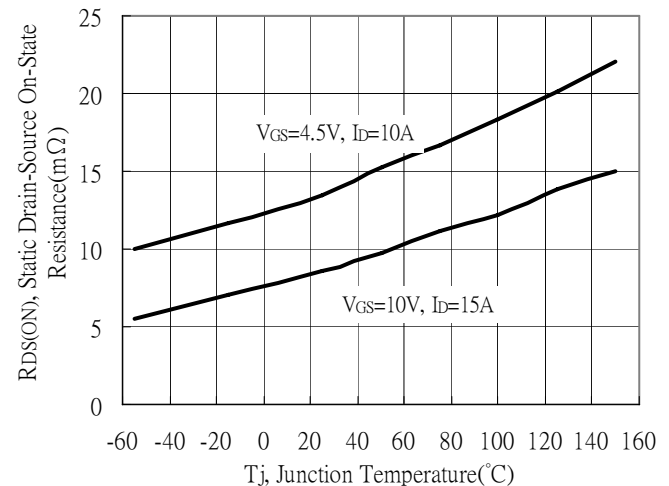



**Typical Characteristics(Cont.)**

Capacitance vs Drain-to-Source Voltage

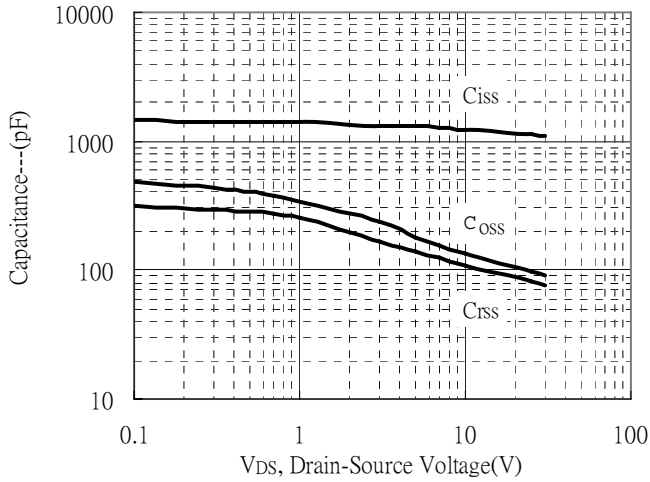

Threshold Voltage vs Junction Temperature

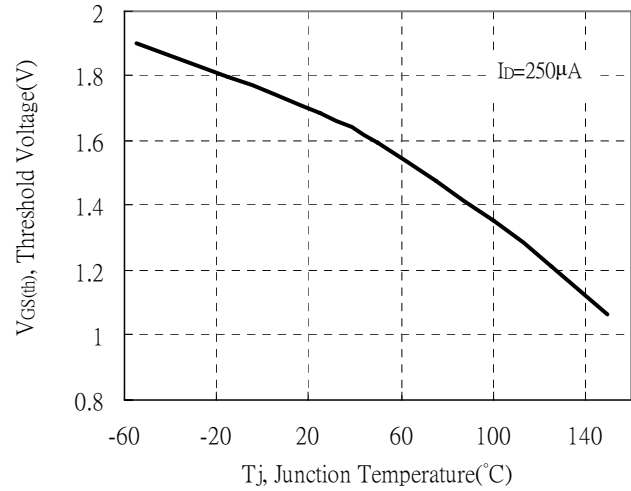

Forward Transfer Admittance vs Drain Current

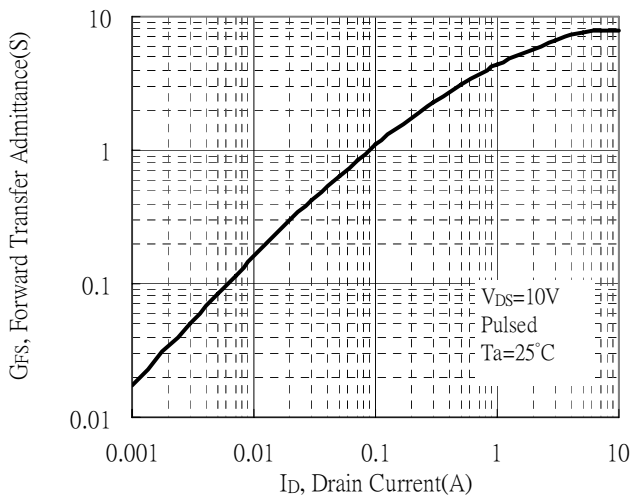

Gate Charge Characteristics

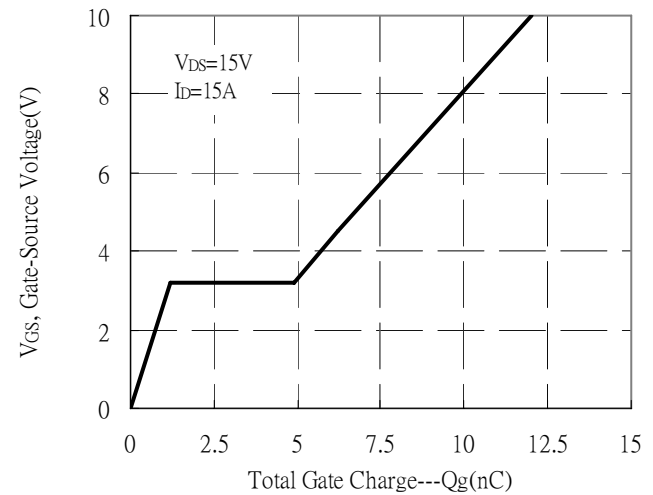

Maximum Safe Operating Area

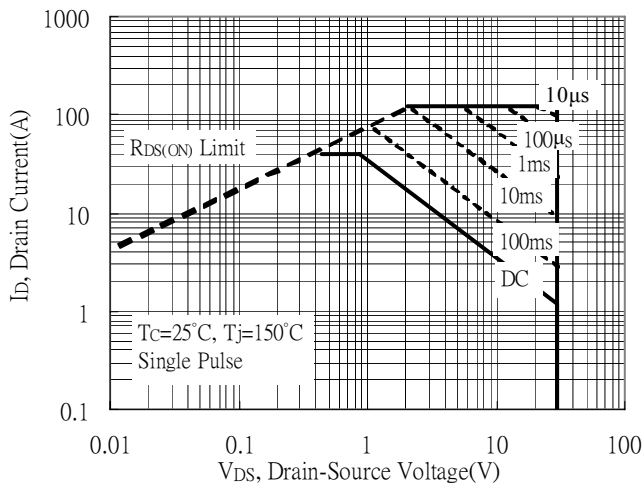

Maximum Drain Current vs Case Temperature

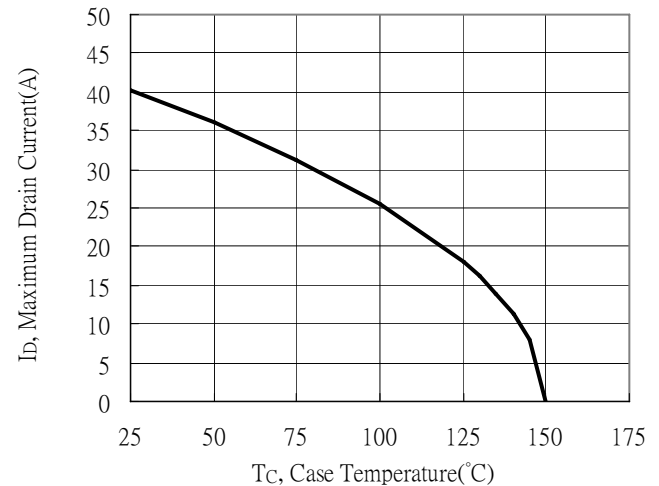

**Typical Characteristics(Cont.)**

Transient Thermal Response Curves

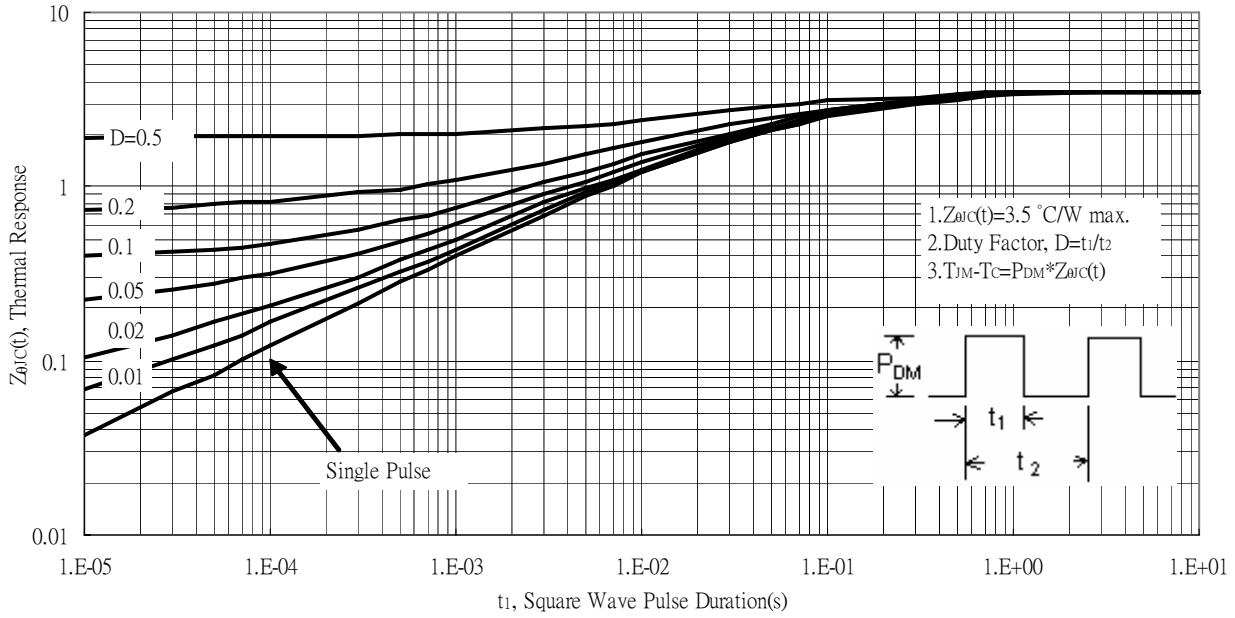



**Recommended wave soldering condition**

|                 |                  |                 |
|-----------------|------------------|-----------------|
| Product         | Peak Temperature | Soldering Time  |
| Pb-free devices | 260 +0/-5 °C     | 5 +1/-1 seconds |

**Recommended temperature profile for IR reflow**

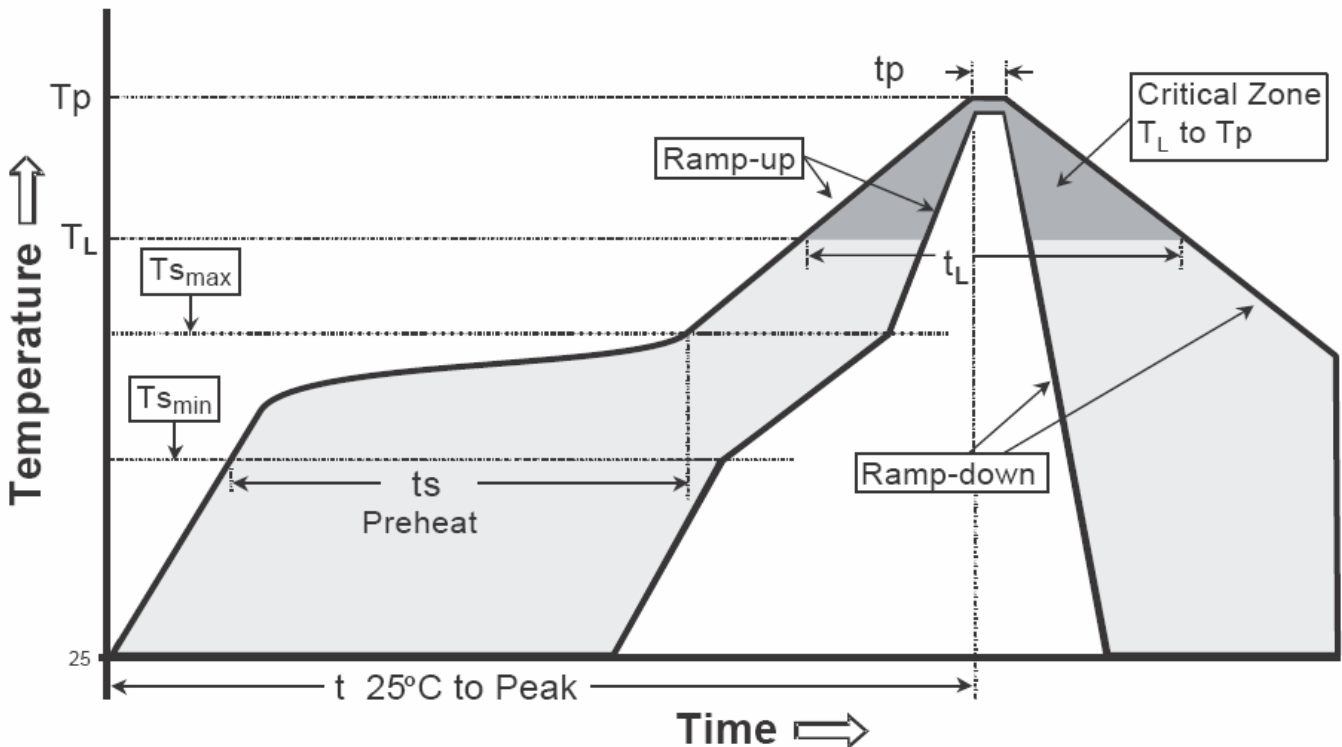

| Profile feature                                | Sn-Pb eutectic Assembly | Pb-free Assembly |
|--|-------------------------|------------------|
| Average ramp-up rate (Tsmax to Tp)             | 3°C/second max.         | 3°C/second max.  |
| Preheat  |                         |                  |
| -Temperature Min(Ts min)                       | 100°C                   | 150°C            |
| -Temperature Max(Ts max)                       | 150°C                   | 200°C            |
| -Time(ts min to ts max)                        | 60-120 seconds          | 60-180 seconds   |
| Time maintained above:                         |                         |                  |
| -Temperature (TL)                              | 183°C                   | 217°C            |
| - Time (tL)                                    | 60-150 seconds          | 60-150 seconds   |
| Peak Temperature(Tp)                           | 240 +0/-5 °C            | 260 +0/-5 °C     |
| Time within 5°C of actual peak temperature(tp) | 10-30 seconds           | 20-40 seconds    |
| Ramp down rate                                 | 6°C/second max.         | 6°C/second max.  |
| Time 25 °C to peak temperature                 | 6 minutes max.          | 8 minutes max.   |

Note : All temperatures refer to topside of the package, measured on the package body surface.



**TO-252 Dimension**

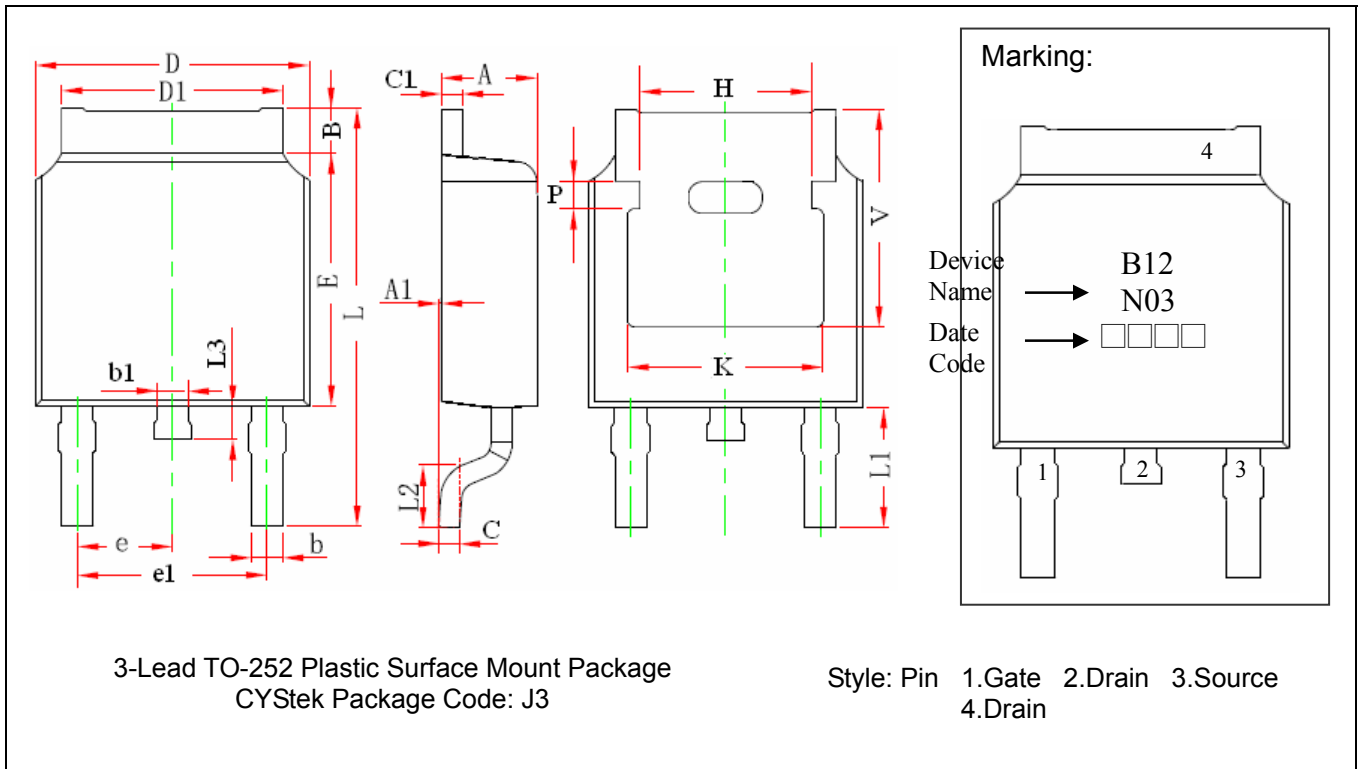

| DIM | Inches |       | Millimeters |       | DIM | Inches |       | Millimeters |        |
|-----|--------|-------|-------------|-------|-----|--------|-------|-------------|--------|
|     | Min.   | Max.  | Min.        | Max.  |     | Min.   | Max.  | Min.        | Max.   |
| A   | 0.087  | 0.094 | 2.200       | 2.400 | e   | 0.086  | 0.094 | 2.186       | 2.386  |
| A1  | 0.000  | 0.005 | 0.000       | 0.127 | e1  | 0.172  | 0.188 | 4.372       | 4.772  |
| B   | 0.039  | 0.048 | 0.990       | 1.210 | H   | 0.163  | REF   | 4.140       | REF    |
| b   | 0.026  | 0.034 | 0.660       | 0.860 | K   | 0.190  | REF   | 4.830       | REF    |
| b1  | 0.026  | 0.034 | 0.660       | 0.860 | L   | 0.386  | 0.409 | 9.800       | 10.400 |
| C   | 0.018  | 0.023 | 0.460       | 0.580 | L1  | 0.114  | REF   | 2.900       | REF    |
| C1  | 0.018  | 0.023 | 0.460       | 0.580 | L2  | 0.055  | 0.067 | 1.400       | 1.700  |
| D   | 0.256  | 0.264 | 6.500       | 6.700 | L3  | 0.024  | 0.039 | 0.600       | 1.000  |
| D1  | 0.201  | 0.215 | 5.100       | 5.460 | P   | 0.026  | REF   | 0.650       | REF    |
| E   | 0.236  | 0.244 | 6.000       | 6.200 | V   | 0.211  | REF   | 5.350       | REF    |

Notes: 1.Controlling dimension: millimeters.  
 2.Maximum lead thickness includes lead finish thickness, and minimum lead thickness is the minimum thickness of base material.  
 3.If there is any question with packing specification or packing method, please contact your local CYStek sales office.

**Material:**

- Lead : Pure tin plated.
- Mold Compound: Epoxy resin family, flammability solid burning class: UL94V-0.

**Important Notice:**

- All rights are reserved. Reproduction in whole or in part is prohibited without the prior written approval of CYStek.
- CYStek reserves the right to make changes to its products without notice.
- CYStek **semiconductor products are not warranted to be suitable for use in Life-Support Applications, or systems.**
- CYStek assumes no liability for any consequence of customer product design, infringement of patents, or application assistance.