

N-Channel Enhancement Mode Power MOSFET

MTB050N10KRQ8

BV_{DSS}	100V
I_D @ T_A=25°C, V_{GS}=10V	5A
R_{DS(ON)}@ V_{GS}=10V, I_D=4A	48mΩ (typ)
R_{DS(ON)}@ V_{GS}=4.5V, I_D=3A	57 mΩ (typ)

Features

- Single drive requirement
- Low on-resistance
- Fast switching characteristic
- ESD protected gate
- Pb-free & halogen-free package

Symbol

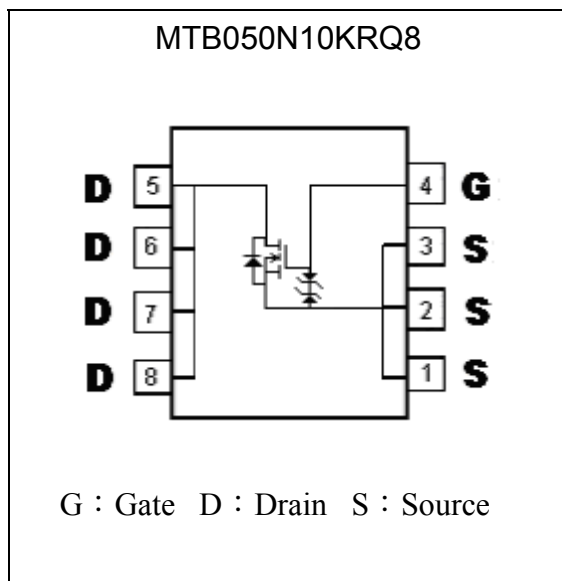

Outline

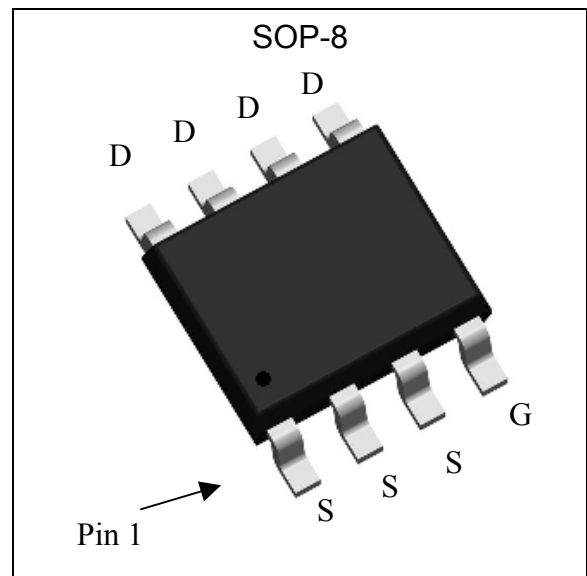

Ordering Information

Device	Package	Shipping
MTB050N10KRQ8-0-T3-G	SOP-8 (RoHS compliant & Halogen-free package)	2500 pcs / Tape & Reel

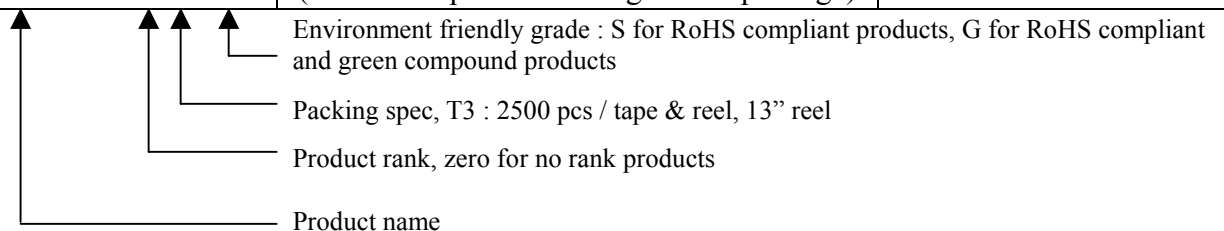



Absolute Maximum Ratings (Tc=25°C, unless otherwise noted)

Parameter	Symbol	Limits	Unit	
Drain-Source Voltage	V _{DS}	100	V	
Gate-Source Voltage	V _{GS}	±20		
Continuous Drain Current @ V _{GS} =10V, T _C =25°C	I _D	6.7	A	
Continuous Drain Current @ V _{GS} =10V, T _C =100°C		4.2		
Continuous Drain Current @ T _A =25°C, V _{GS} =10V		5.0 (Note 3)		
Continuous Drain Current @ T _A =70°C, V _{GS} =10V		4.0 (Note 3)		
Continuous Drain Current @ T _A =25°C, V _{GS} =10V		3.0 (Note 4)		
Continuous Drain Current @ T _A =70°C, V _{GS} =10V		2.4 (Note 4)		
Pulsed Drain Current		I _{DM}		27 (Note 1)
Avalanche Current @ L=0.1mH	I _{AS}	24	mJ	
Avalanche Energy @ L=1mH, I _D =10A, V _{DD} =25V	E _{AS}	50 (Note 2)		
Repetitive Avalanche Energy @ L=0.05mH	E _{AR}	1.6 (Note 2)		
Total Power Dissipation	P _D	T _A =25 °C	3.1	W
		T _A =70 °C	2.0	
Operating Junction and Storage Temperature	T _j , T _{stg}	-55~+150	°C	

Thermal Data

Parameter	Symbol	Value	Unit
Thermal Resistance, Junction-to-case	R _{θJC}	25	°C/W
Thermal Resistance, Junction-to-ambient (Note 3)	R _{θJA}	40	
Thermal Resistance, Junction-to-ambient (Note 4)		125	

- Note : 1. Pulse width limited by maximum junction temperature
 2. Duty cycle ≤ 1%
 3. When mounted on a 1 in² pad of 2 oz copper, t≤10s.
 4. When mounted on minimum pad.

Characteristics (Tc=25°C, unless otherwise specified)

Symbol	Min.	Typ.	Max.	Unit	Test Conditions
Static					
BV _{DSS}	100	-	-	V	V _{GS} =0V, I _D =250μA
V _{GS(th)}	1	-	2.5		V _{DS} = V _{GS} , I _D =250μA
G _{FS}	-	8	-	S	V _{DS} =10V, I _D =3A
I _{GSS}	-	-	±10	μA	V _{GS} =±16V, V _{DS} =0V
I _{DSS}	-	-	1		V _{DS} =80V, V _{GS} =0V
	-	-	25		V _{DS} =80V, V _{GS} =0V, T _j =125°C
*R _{DS(ON)}	-	48	63	mΩ	V _{GS} =10V, I _D =4A
	-	57	80		V _{GS} =4.5V, I _D =3A
Dynamic					
Q _g *1, 2	-	16.6	25	nC	V _{DS} =50V, I _D =4A, V _{GS} =10V
Q _{gs} *1, 2	-	3	-		
Q _{gd} *1, 2	-	2.6	-		

Ciss	-	982	1473	pF	V _{DS} =50V, V _{GS} =0V, f=1MHz
Coss	-	60	90		
Crss	-	23	35		
Dynamic					
t _{d(ON)} *1, 2	-	9.2	13.8	ns	V _{DS} =50V, I _D =4A, V _{GS} =10V, R _G =3Ω
t _r *1, 2	-	15.4	23.1		
t _{d(OFF)} *1, 2	-	30.8	46.2		
t _f *1, 2	-	4.4	6.6		
R _g	-	1.6	-	Ω	f=1MHz
Source-Drain Diode Ratings and Characteristics					
I _S *1	-	-	4	A	
I _{SM} *3	-	-	16		
V _{SD} *1	-	0.79	1.2	V	I _S =2A, V _{GS} =0V
t _{rr}	-	22.5	-	ns	I _F =4A, dI _F /dt=100A/μs
Q _{rr}	-	24.1	-	nC	

Note : *1.Pulse Test : Pulse Width ≤300μs, Duty Cycle≤2%
 *2.Independent of operating temperature
 *3.Pulse width limited by maximum junction temperature.

Recommended Soldering Footprint

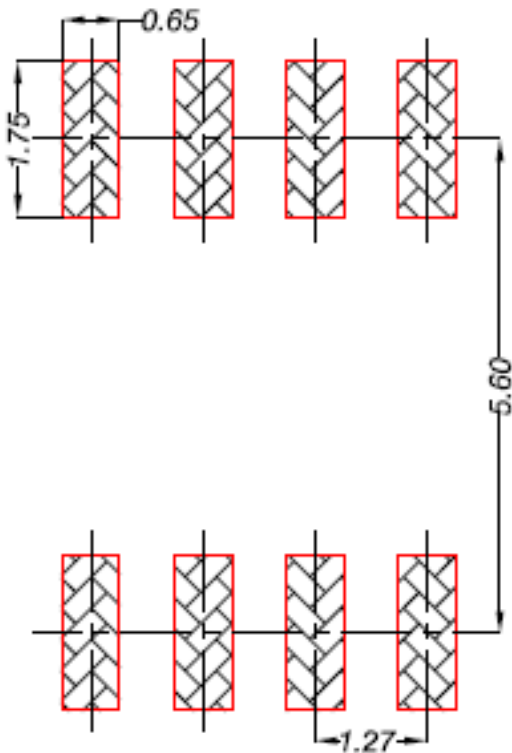



Typical Characteristics

Typical Output Characteristics

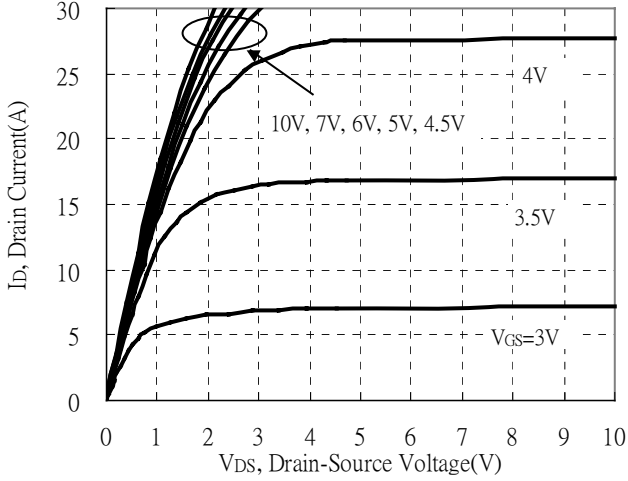

Brekdown Voltage vs Ambient Temperature

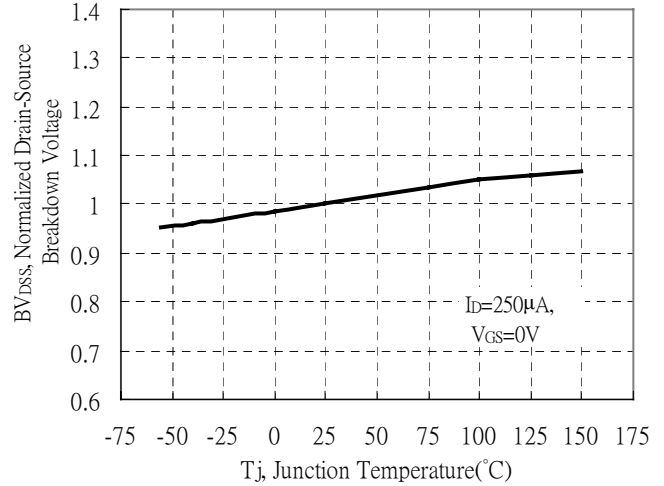

Static Drain-Source On-State resistance vs Drain Current

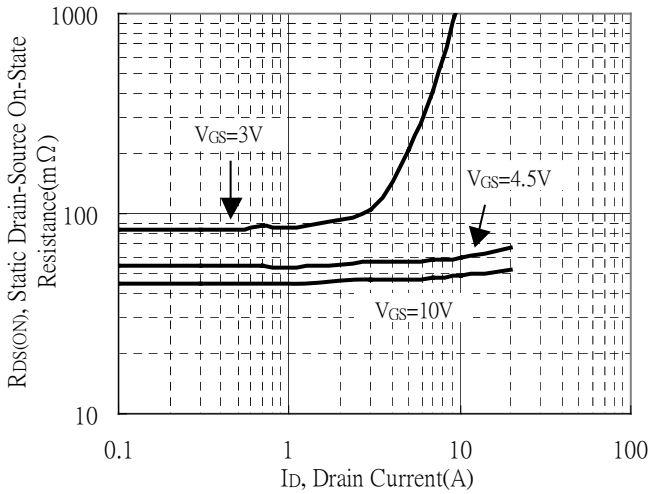

Reverse Drain Current vs Source-Drain Voltage

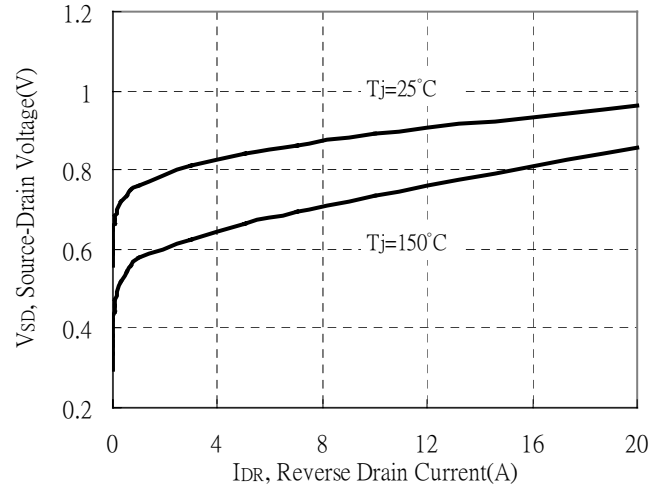

Static Drain-Source On-State Resistance vs Gate-Source Voltage

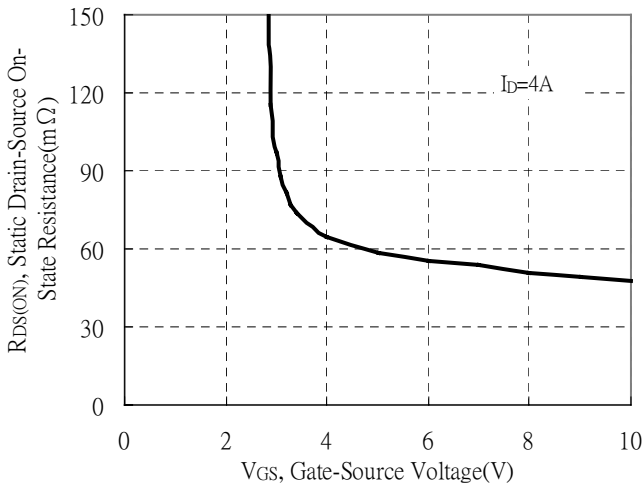

Drain-Source On-State Resistance vs Junction Temperature

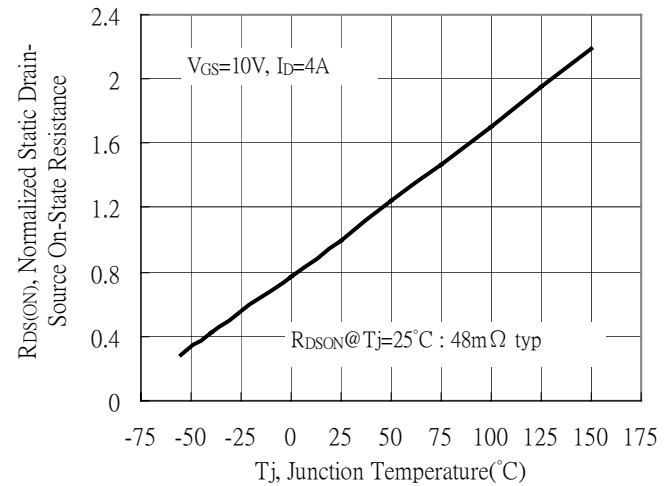

Typical Characteristics(Cont.)

Capacitance vs Drain-to-Source Voltage

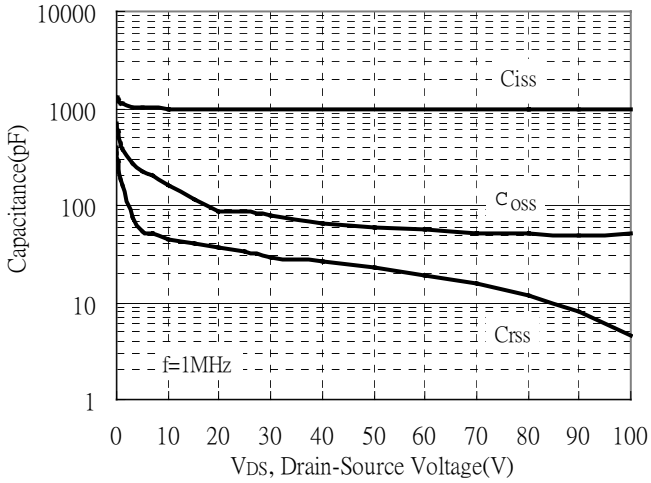

Threshold Voltage vs Junction Temperature

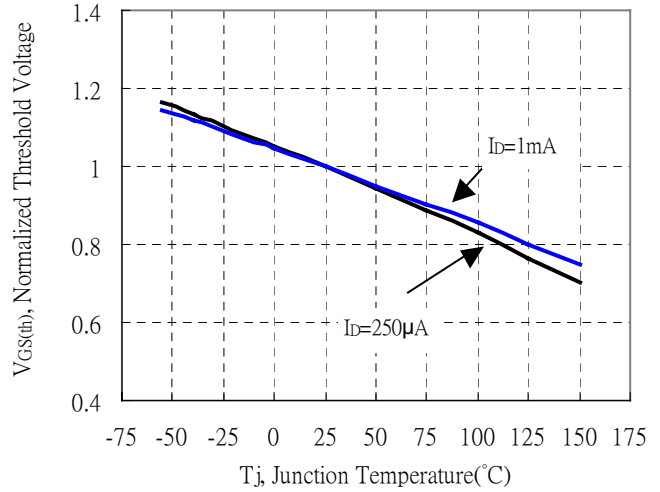

Forward Transfer Admittance vs Drain Current

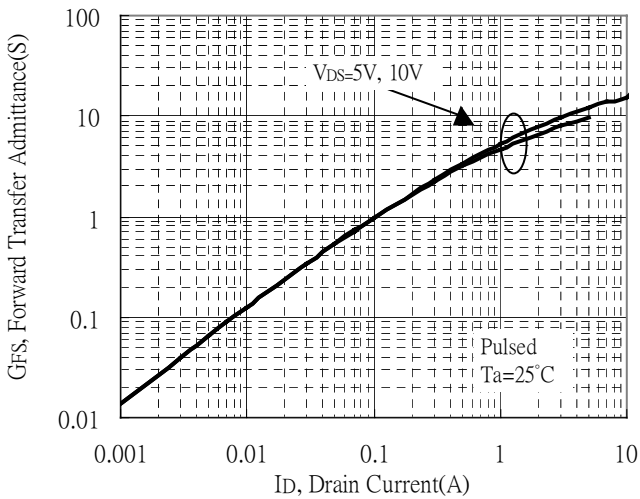

Gate Charge Characteristics

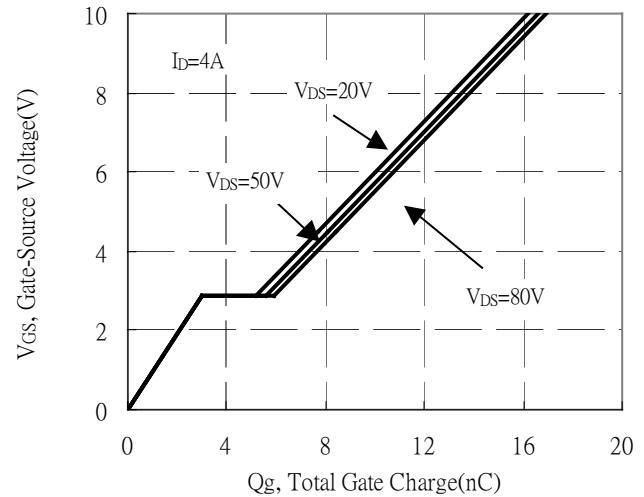

Maximum Safe Operating Area

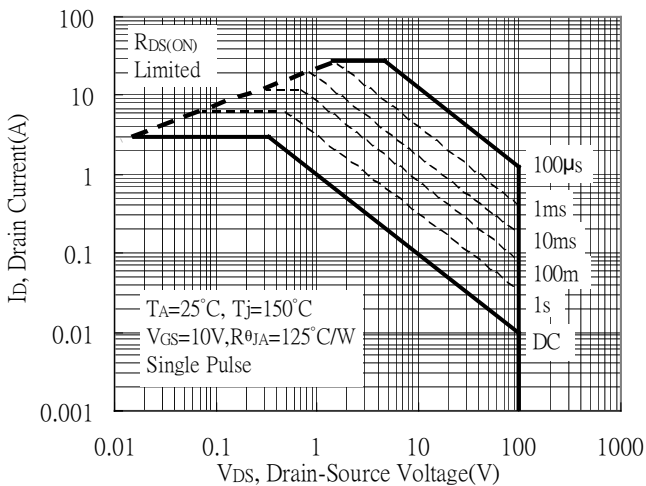

Maximum Drain Current vs Junction Temperature

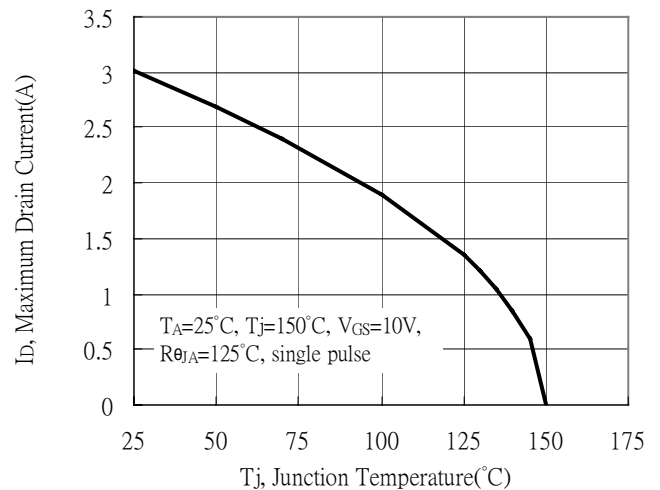



Typical Characteristics(Cont.)

Typical Transfer Characteristics

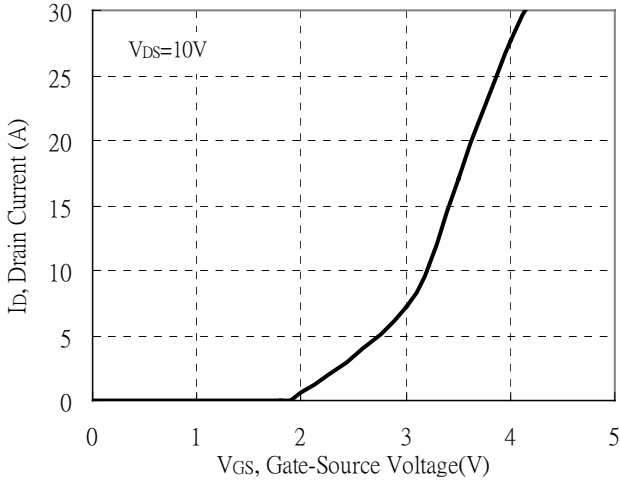

Single Pulse Power Rating, Junction to Ambient
 (Note on page 2)

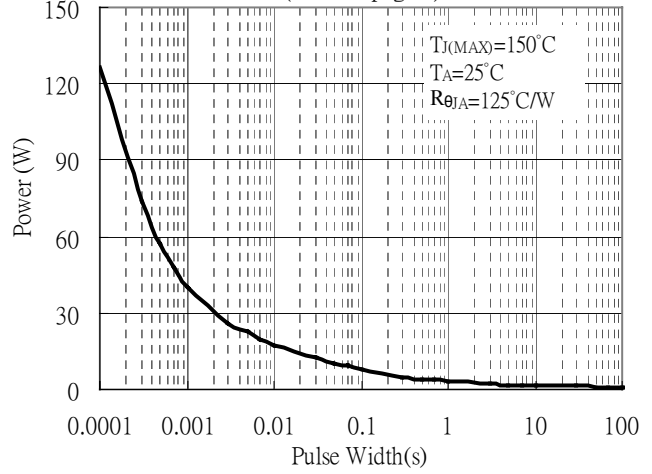

Transient Thermal Response Curves

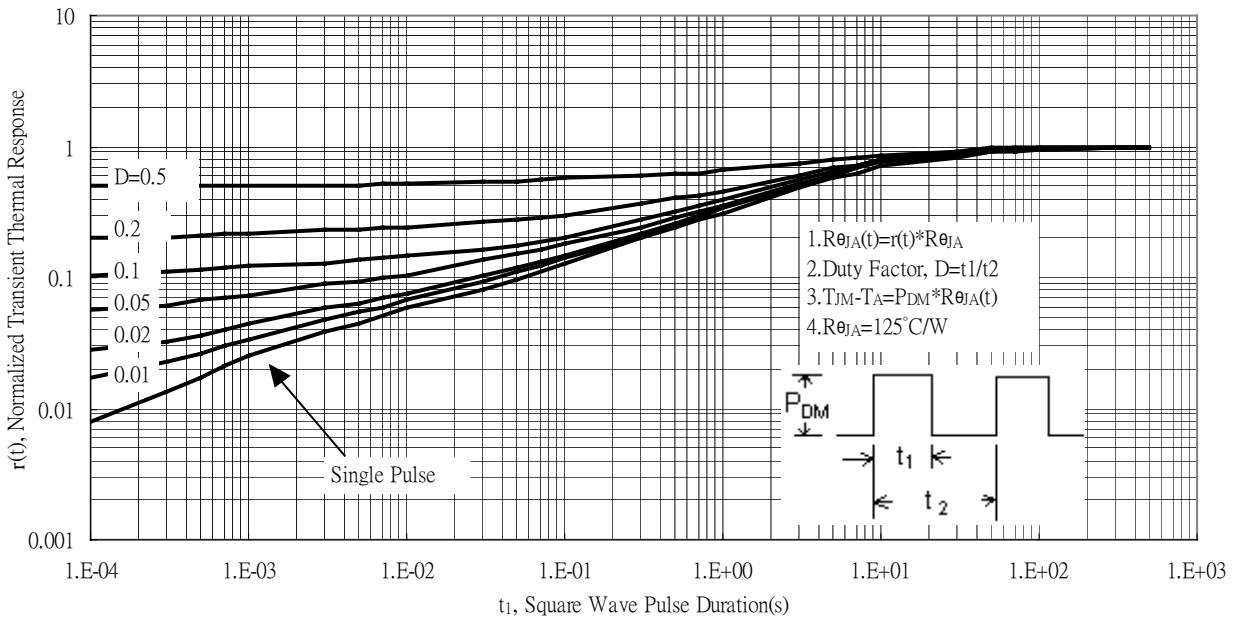

Reel Dimension

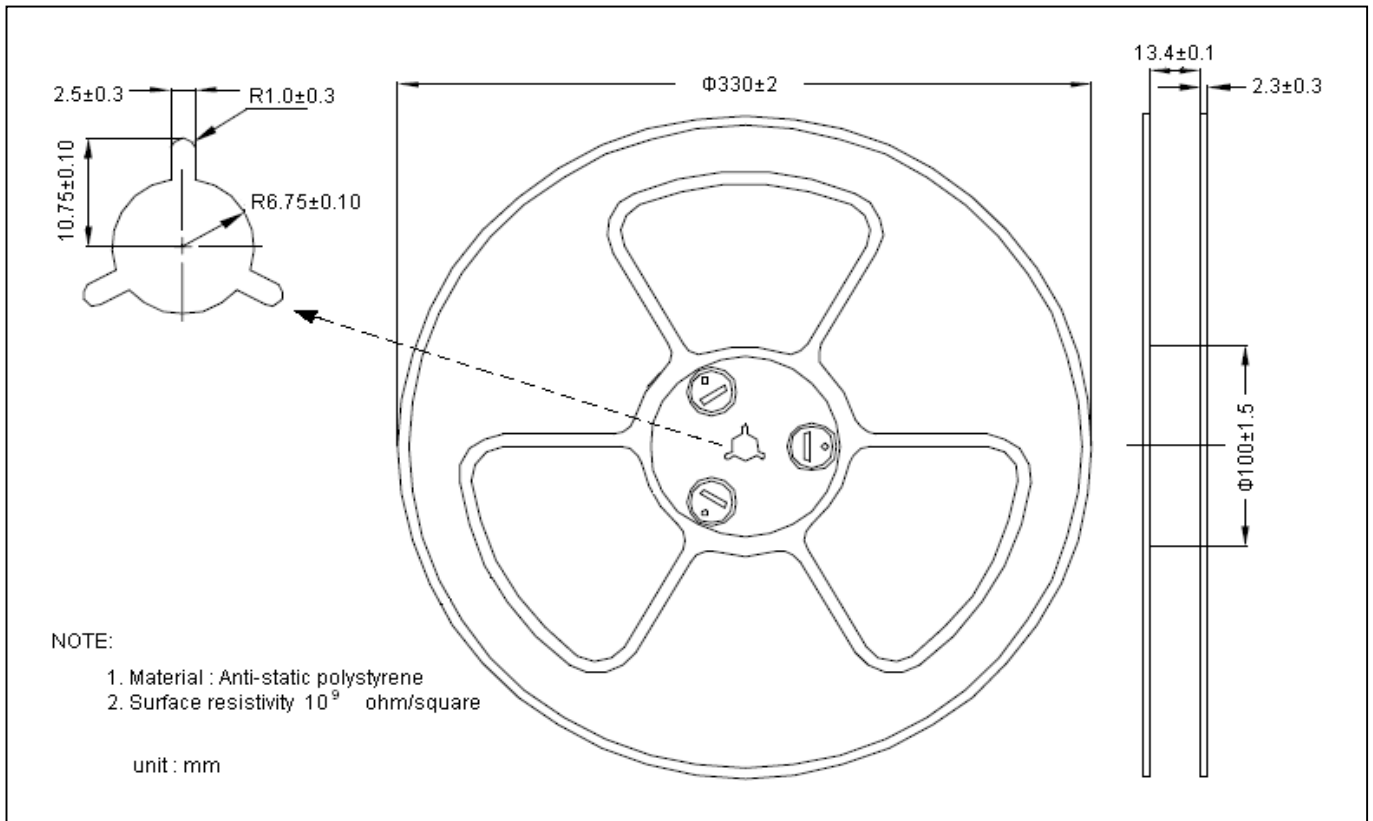

Carrier Tape Dimension

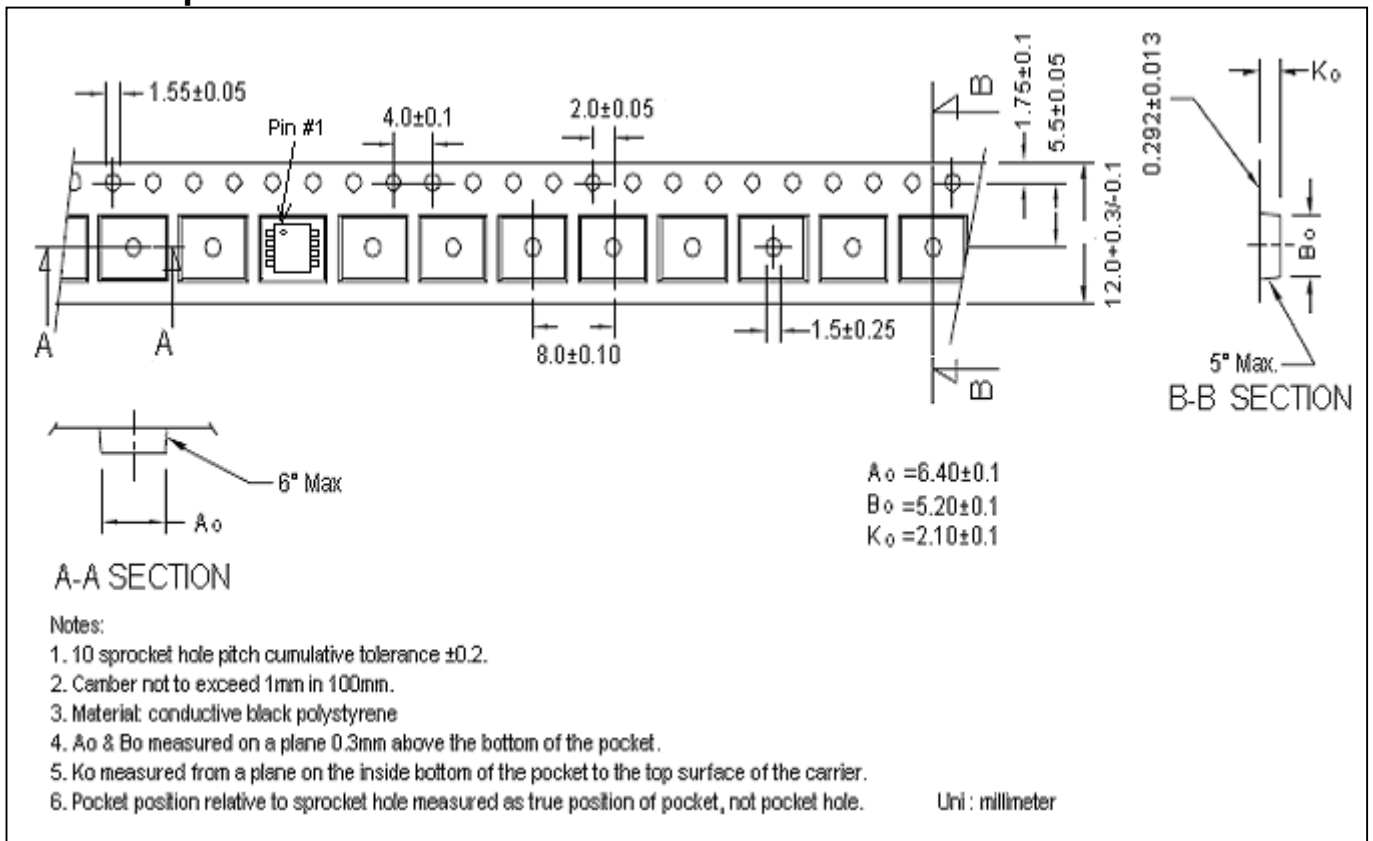

Recommended wave soldering condition

Product	Peak Temperature	Soldering Time
Pb-free devices	260 +0/-5 °C	5 +1/-1 seconds

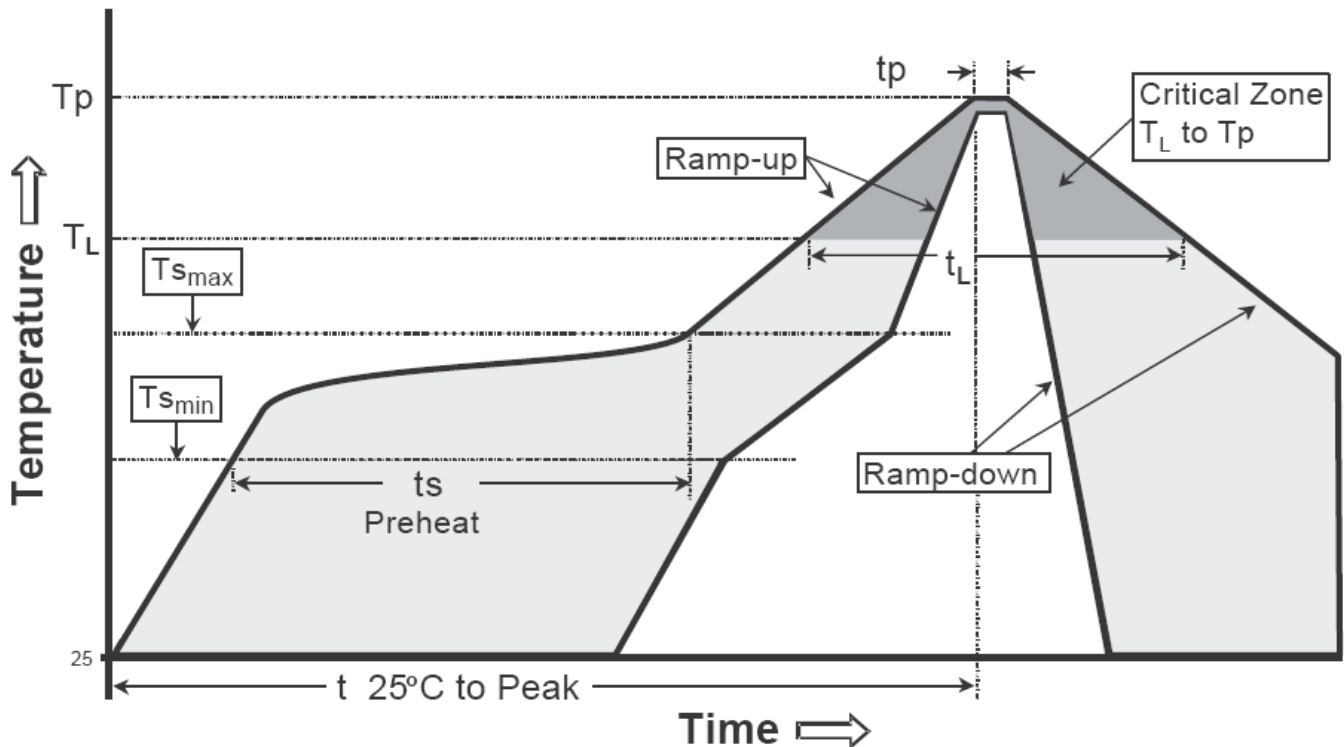
Recommended temperature profile for IR reflow

Profile feature	Sn-Pb eutectic Assembly	Pb-free Assembly
Average ramp-up rate (T _{smax} to T _p)	3°C/second max.	3°C/second max.
Preheat		
-Temperature Min(T _{s min})	100°C	150°C
-Temperature Max(T _{s max})	150°C	200°C
-Time(t _{s min} to t _{s max})	60-120 seconds	60-180 seconds
Time maintained above:		
-Temperature (T _L)	183°C	217°C
- Time (t _L)	60-150 seconds	60-150 seconds
Peak Temperature(T _P)	240 +0/-5 °C	260 +0/-5 °C
Time within 5°C of actual peak temperature(tp)	10-30 seconds	20-40 seconds
Ramp down rate	6°C/second max.	6°C/second max.
Time 25 °C to peak temperature	6 minutes max.	8 minutes max.

Note :1. All temperatures refer to topside of the package, measured on the package body surface.

2.For devices mounted on FR-4 PCB of 1.6mm or equivalent grade PCB. If other grade PCB is used, care should be taken to match the coefficients of thermal expansion between components and PCB. If they are not matched well, the solder joints may crack or the bodies of the parts may crack or shatter as the assembly cools.

SOP-8 Dimension

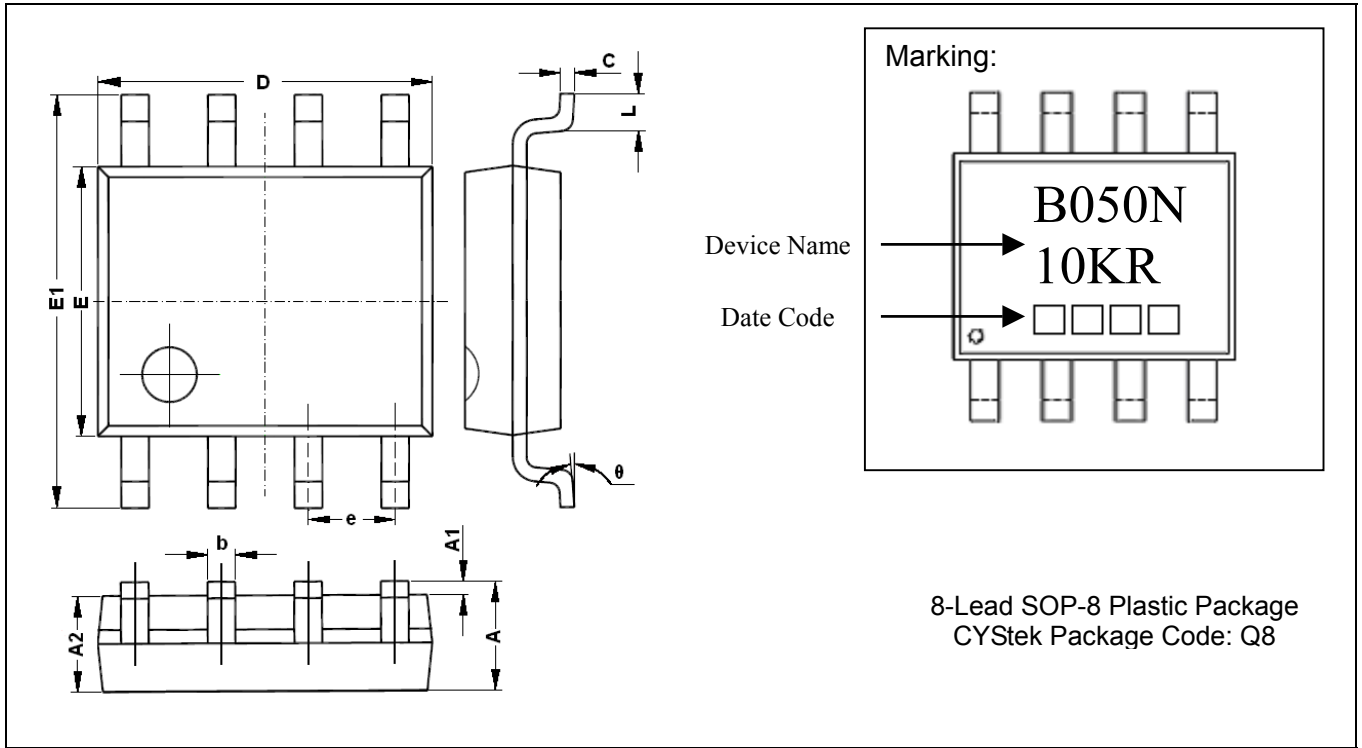

DIM	Millimeters		Inches		DIM	Millimeters		Inches	
	Min.	Max.	Min.	Max.		Min.	Max.	Min.	Max.
A	1.350	1.750	0.053	0.069	E	3.800	4.200	0.150	0.165
A1	0.100	0.250	0.004	0.010	E1	5.800	6.200	0.228	0.244
A2	1.350	1.550	0.053	0.061	e	1.270 (BSC)	0.050 (BSC)		
b	0.330	0.510	0.013	0.020	L	0.300	1.270	0.012	0.050
c	0.170	0.250	0.006	0.010	θ	0	8°	0	8°
D	4.700	5.100	0.185	0.200					

Notes: 1. Controlling dimension: millimeters.
 2. Maximum lead thickness includes lead finish thickness, and minimum lead thickness is the minimum thickness of base material.
 3. If there is any question with packing specification or packing method, please contact your local CYStek sales office.

Material:

- Lead: Pure tin plated.
- Mold Compound: Epoxy resin family, flammability solid burning class: UL94V-0.

Important Notice:

- All rights are reserved. Reproduction in whole or in part is prohibited without the prior written approval of CYStek.
- CYStek reserves the right to make changes to its products without notice.
- CYStek **semiconductor products are not warranted to be suitable for use in Life-Support Applications, or systems.**
- CYStek assumes no liability for any consequence of customer product design, infringement of patents, or application assistance.