

Dual P-Channel Enhancement Mode MOSFET

MTB030B03V8

| | |
|--------------------------------------------------------------------|----------------|
| BV _{DSS} | -30V |
| I _D @V _{GS} =-10V, T _A =25°C | -4.5A |
| I _D @V _{GS} =-10V, T _c =25°C | -6.1A |
| R _{DS(on)} @V _{GS} =-10V, I _D =-5A | 27.8 mΩ (typ.) |
| R _{DS(on)} @V _{GS} =-4.5V, I _D =-2.5A | 39 mΩ (typ.) |

Features

- Simple drive requirement
- Low on-resistance
- Fast switching speed
- Pb-free lead plating and halogen-free package

Equivalent Circuit

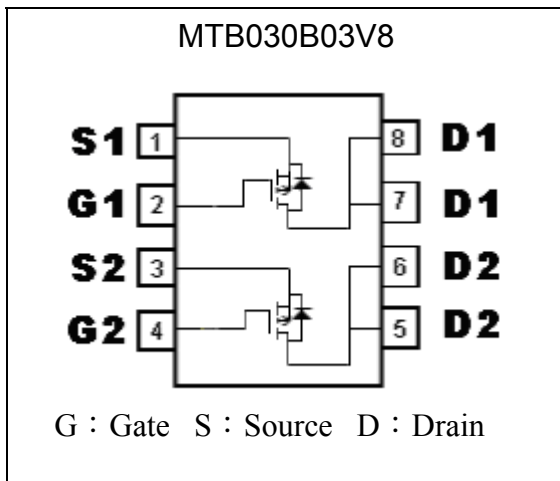

Outline

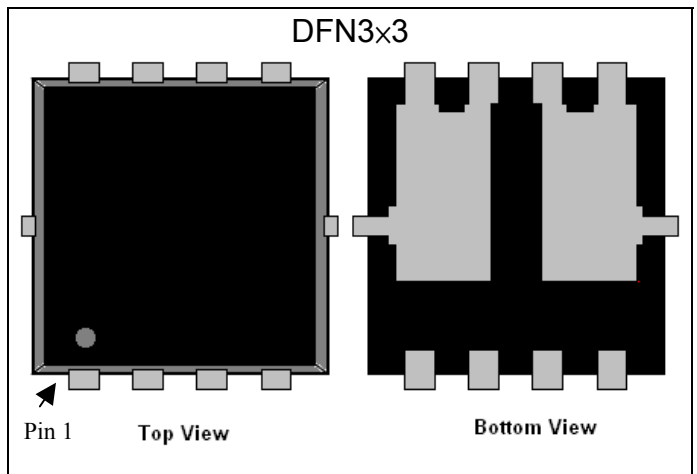

Ordering Information

| Device | Package | Shipping |
|--------------------|-----------------------------------------------------------|------------------------|
| MTB030B03V8-0-T6-G | DFN3x3 (Pb-free lead plating and halogen-free package) | 3000 pcs / Tape & Reel |

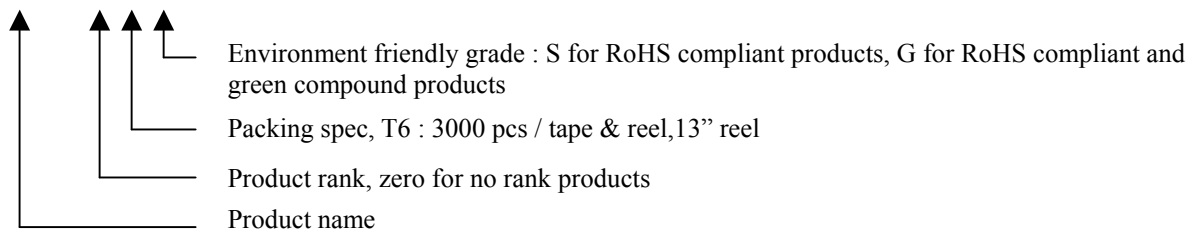



Absolute Maximum Ratings (T_C=25°C, unless otherwise noted)

| Parameter | | Symbol | Limits | Unit |
|--------------------------------------------------|-------------------------------------------------------------|-----------------------------------|----------|------|
| Drain-Source Breakdown Voltage | | BV _{DSS} | -30 | V |
| Gate-Source Voltage | | V _{GS} | ±20 | |
| Continuous Drain Current *2 | T _A =25 °C, V _{GS} =10V (-10V) | I _{DSM} | -4.5 | A |
| | T _A =70 °C, V _{GS} =10V (-10V) | | -3.6 | |
| Continuous Drain Current | T _C =25 °C, V _{GS} =10V (-10V) | I _D | -6.1 | |
| | T _C =100 °C, V _{GS} =10V (-10V) | | -3.9 | |
| Pulsed Drain Current *1 | | I _{DM} | -30 | |
| Total Power Dissipation | T _A =25°C, Single device operation | P _{DSM} | 1.5 *2 | W |
| | T _A =70°C, Single device operation | | 0.96 *2 | |
| | T _A =25°C, Single device value at dual operation | | 1.24 *2 | |
| | T _A =70°C, Single device value at dual operation | | 0.79 *2 | |
| | T _C =25°C | P _D | 2.8 | |
| | T _C =100°C | | 1.1 | |
| Operating Junction and Storage Temperature Range | | T _j ; T _{stg} | -55~+150 | °C |

Thermal Data

| Parameter | Symbol | Value | Unit |
|-------------------------------------------------------------------------------------|------------------|--------|------|
| Max. Thermal Resistance, Junction-to-ambient, single device operation | R _{θJA} | 84 *2 | °C/W |
| Max. Thermal Resistance, Junction-to-ambient, single device value at dual operation | | 101 *2 | |
| Max. Thermal Resistance, Junction-to-case | R _{θJC} | 45 | |

Note : 1. Pulse width limited by maximum junction temperature.
 2. Surface mounted on a 1 in² pad of 2oz copper, t≤5s. In practice R_{th,j-a} will be determined by customer's PCB characteristics. 216°C/W when mounted on a minimum pad of 2 oz. copper.

Electrical Characteristics (T_C=25°C, unless otherwise specified)

| Symbol | Min. | Typ. | Max. | Unit | Test Conditions |
|----------------------|------|------|------|------|------------------------------------------------------------------|
| Static | | | | | |
| BV _{DSS} | -30 | - | - | V | V _{GS} =0V, I _D =-250μA |
| V _{GS(th)} | -1.0 | - | -2.5 | | V _{DS} =V _{GS} , I _D =-250μA |
| I _{GSS} | - | - | ±100 | nA | V _{GS} =±20V, V _{DS} =0V |
| I _{DSS} | - | - | -1 | μA | V _{DS} =-24V, V _{GS} =0V |
| | - | - | -10 | | V _{DS} =-24V, V _{GS} =0V, T _j =70°C |
| *R _{D(S)ON} | - | 27.8 | 36 | mΩ | V _{GS} =-10V, I _D =-5A |
| | - | 39 | 52 | | V _{GS} =-4.5V, I _D =-2.5A |
| *G _{FS} | - | 7 | - | S | V _{DS} =-5V, I _D =-5A |
| Dynamic | | | | | |
| C _{iss} | - | 906 | - | pF | V _{DS} =-20V, V _{GS} =0V, f=1MHz |
| C _{oss} | - | 101 | - | | |
| C _{rss} | - | 77 | - | | |

| | | | | | |
|-------------------|---|-------|------|----|---------------------------------------------------------------------------------------|
| *td(ON) | - | 7.2 | - | ns | V _{DS} =-15V, I _D =-1A, V _{GS} =-10V, R _G =6Ω |
| *tr | - | 18.6 | - | | |
| *td(OFF) | - | 91.2 | - | | |
| *tf | - | 40.2 | - | | |
| *Qg | - | 20 | - | nC | V _{DS} =-15V, I _D =-5A, V _{GS} =-10V |
| *Qgs | - | 3.4 | - | | |
| *Qgd | - | 4.0 | - | | |
| Body Diode | | | | | |
| *I _S | - | - | -2.3 | A | |
| *I _{SM} | - | - | -9.2 | | |
| *V _{SD} | - | -0.85 | -1.2 | V | V _{GS} =0V, I _S =-5A |
| *trr | - | 10.5 | - | ns | I _F =-4.5A, V _{GS} =0V, dI _F /dt=100A/μs |
| *Q _{rr} | - | 5.2 | - | nC | |

*Pulse Test : Pulse Width ≤300μs, Duty Cycle ≤2%

Recommended Soldering Footprint

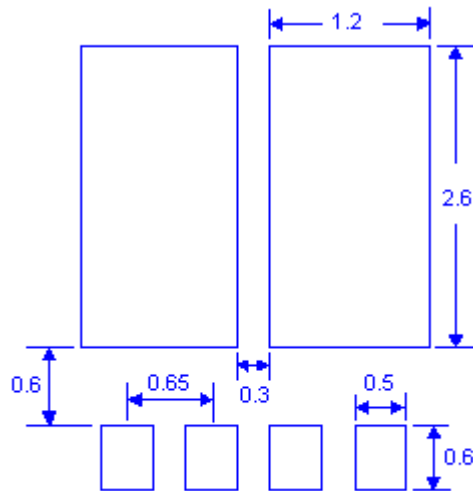

unit : mm



Typical Characteristics :

Typical Output Characteristics

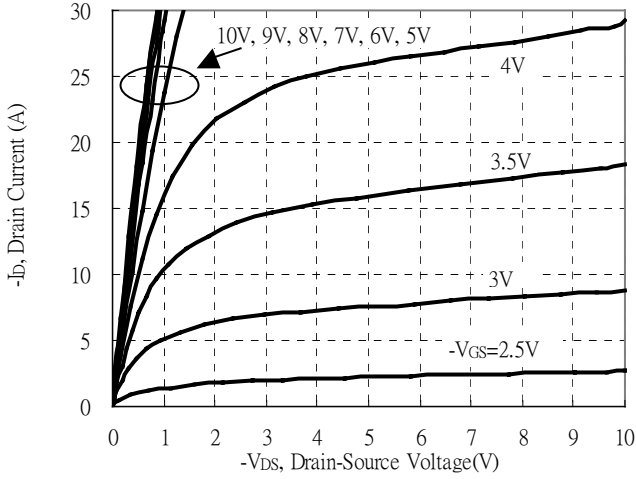

Breakdown Voltage vs Ambient Temperature

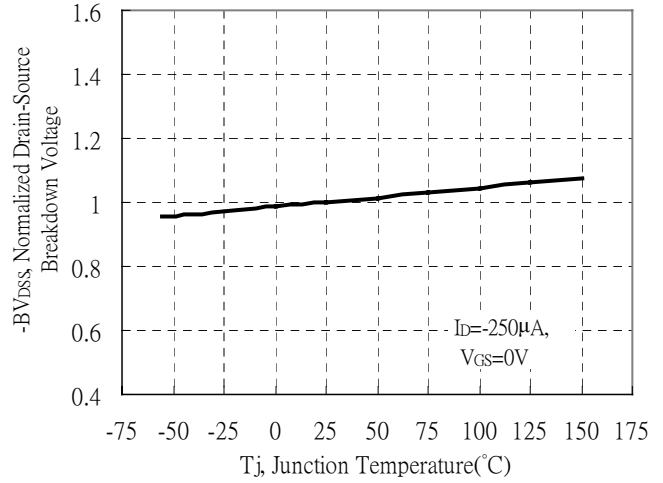

Static Drain-Source On-State resistance vs Drain Current

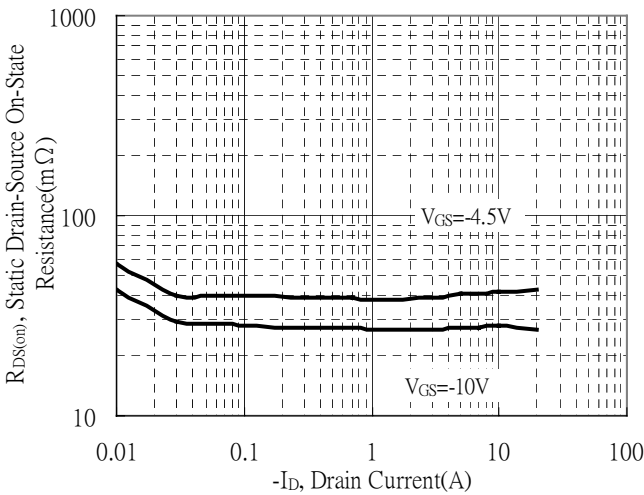

Reverse Drain Current vs Source-Drain Voltage

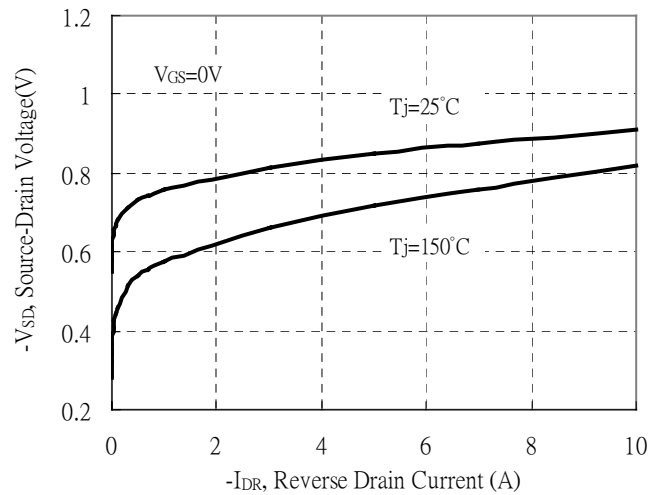

Static Drain-Source On-State Resistance vs Gate-Source Voltage

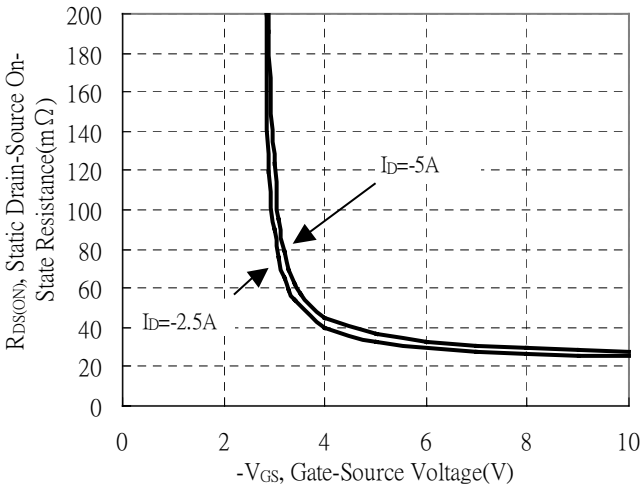

Drain-Source On-State Resistance vs Junction Temperature

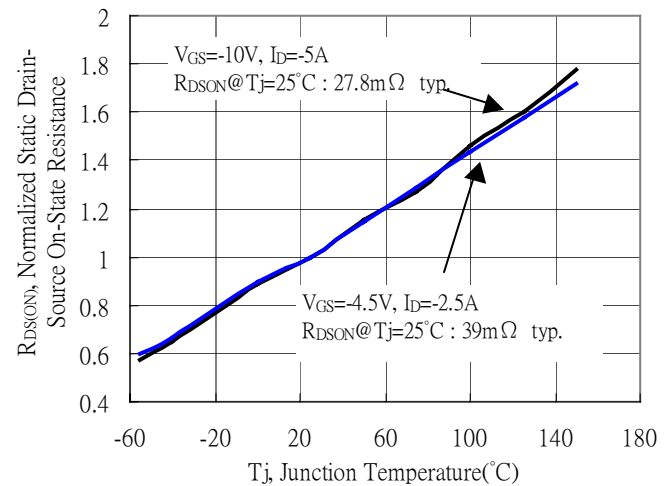

Typical Characteristics(Cont.)

Capacitance vs Drain-to-Source Voltage

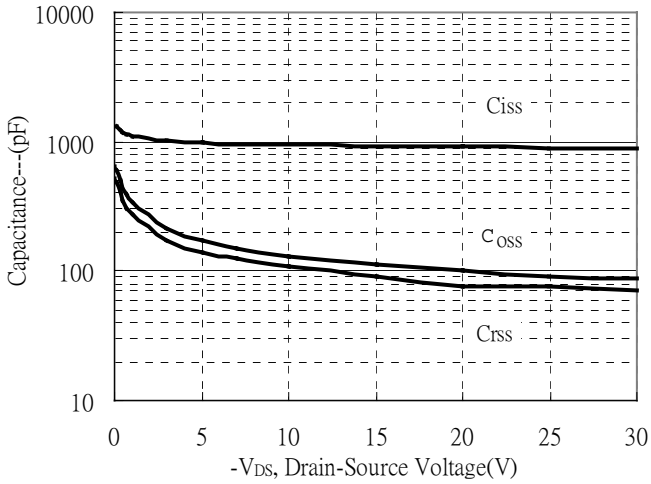

Threshold Voltage vs Junction Temperature

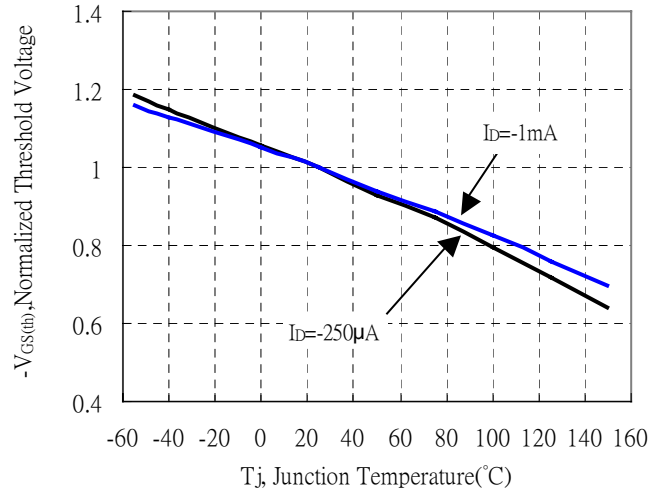

Forward Transfer Admittance vs Drain Current

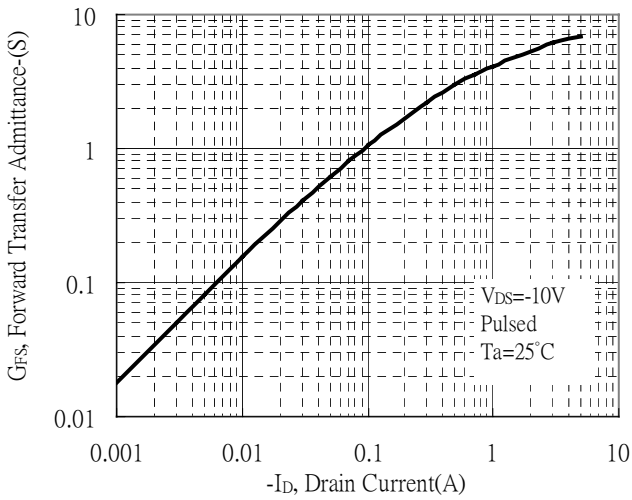

Gate Charge Characteristics

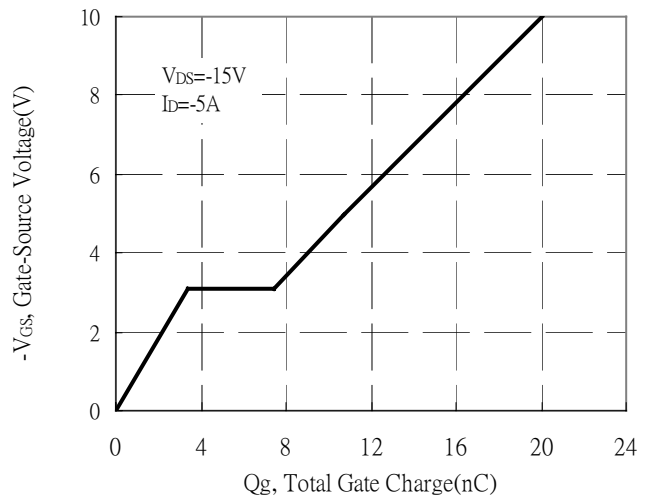

Maximum Safe Operating Area

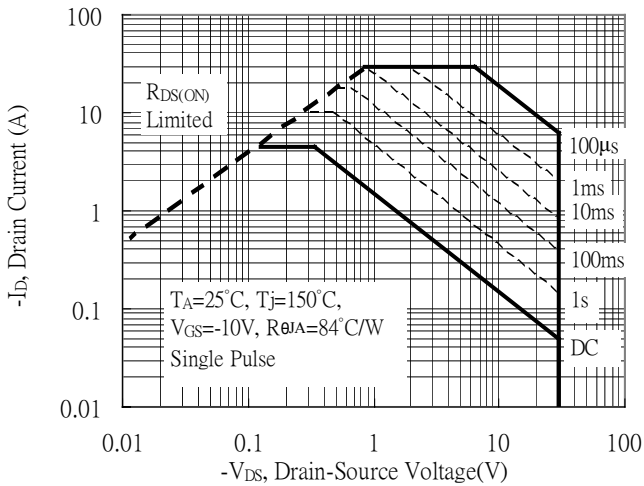

Maximum Drain Current vs Junction Temperature

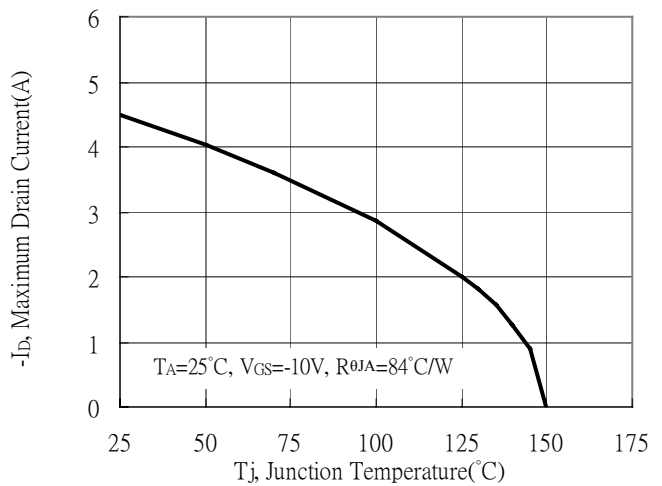

Typical Characteristics(Cont.)

Typical Transfer Characteristics

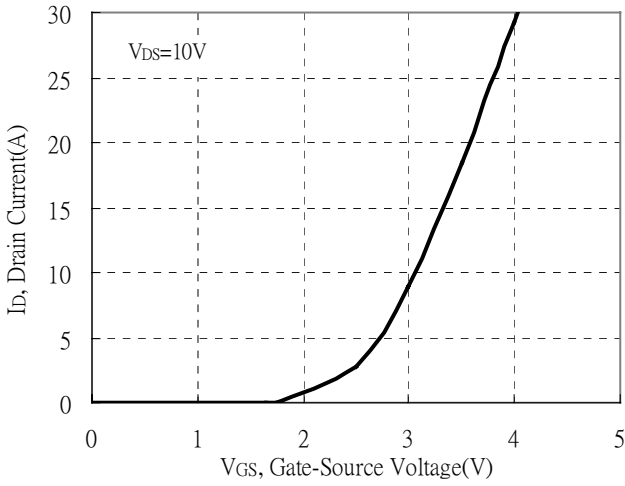

Single Pulse Power Rating, Junction to Ambient

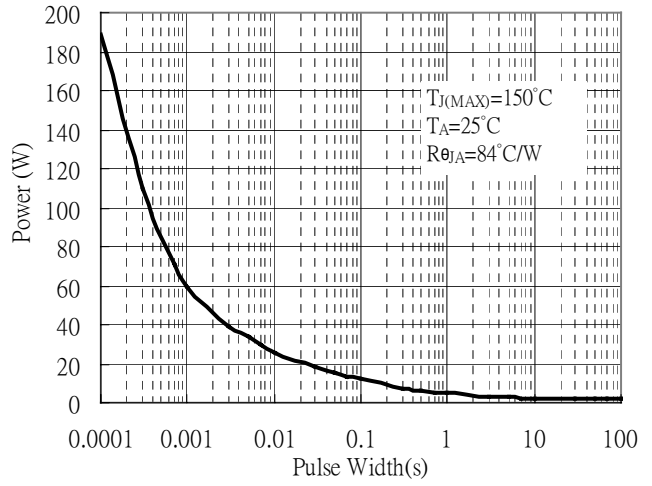

Transient Thermal Response Curves

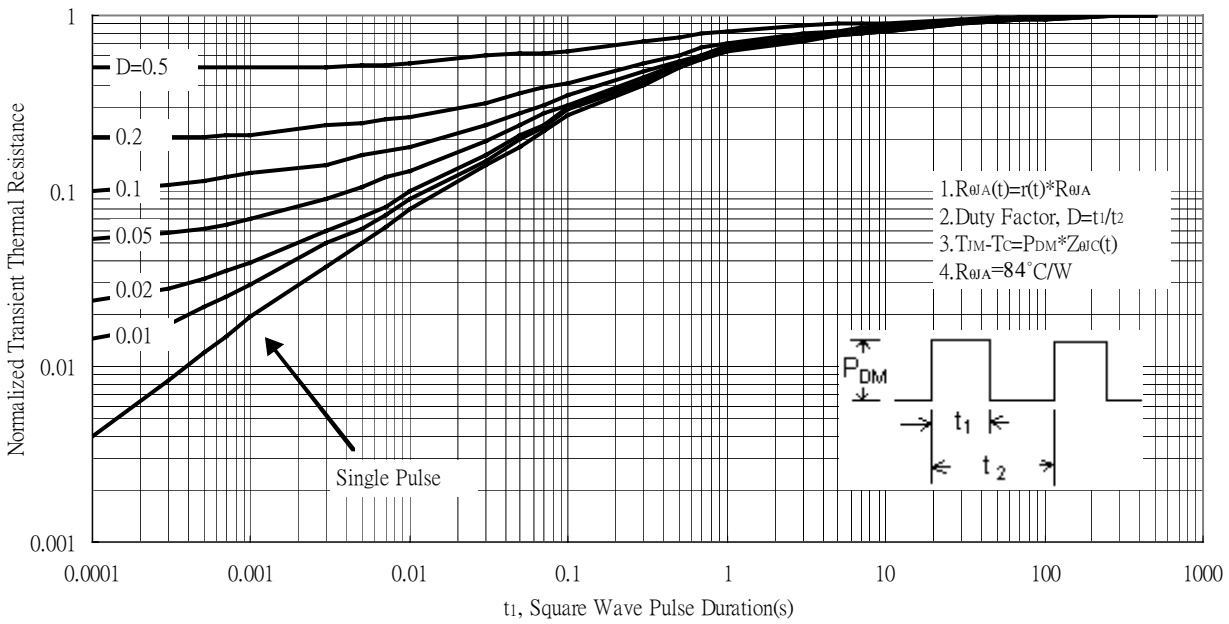

Reel Dimension

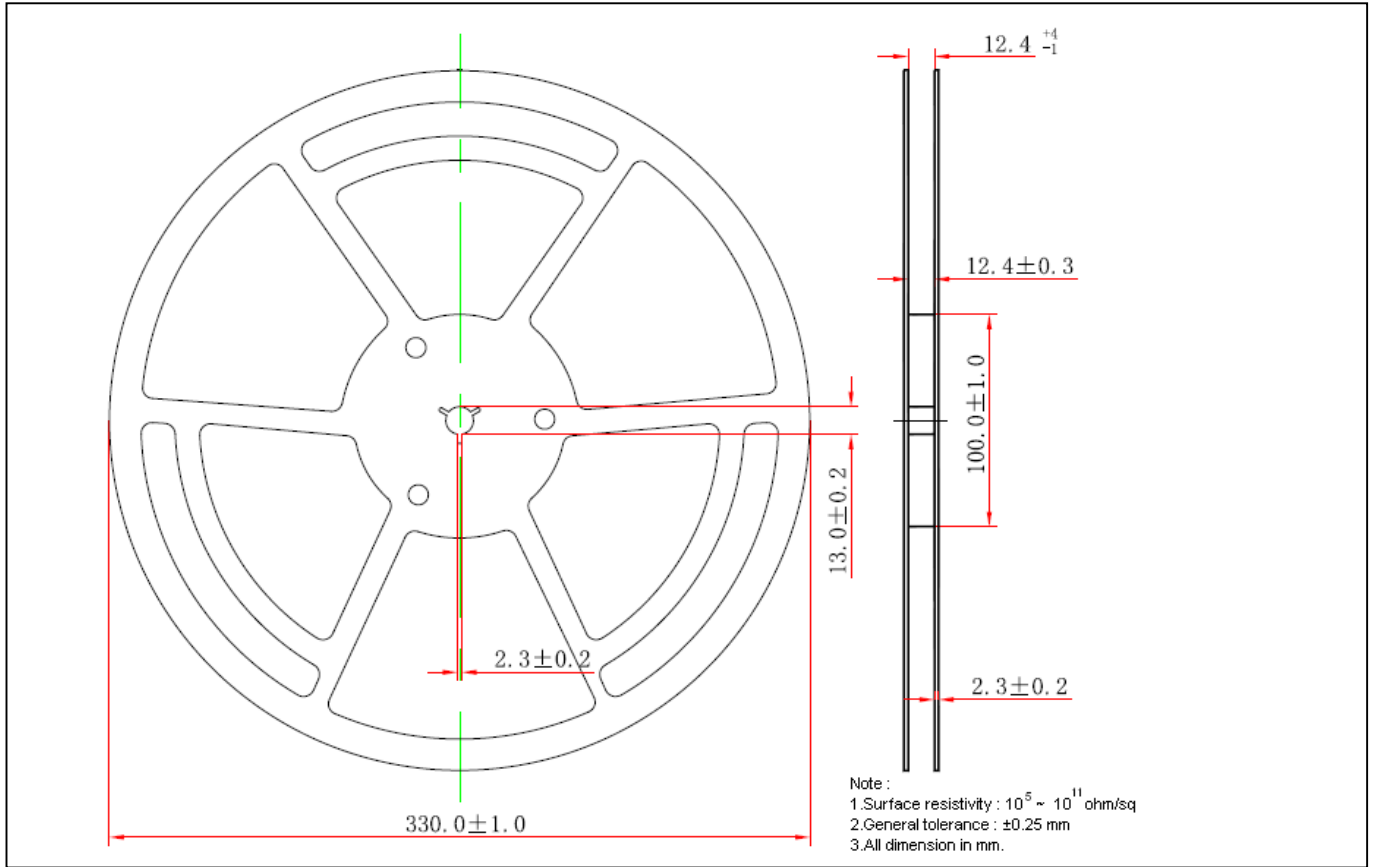

Carrier Tape Dimension

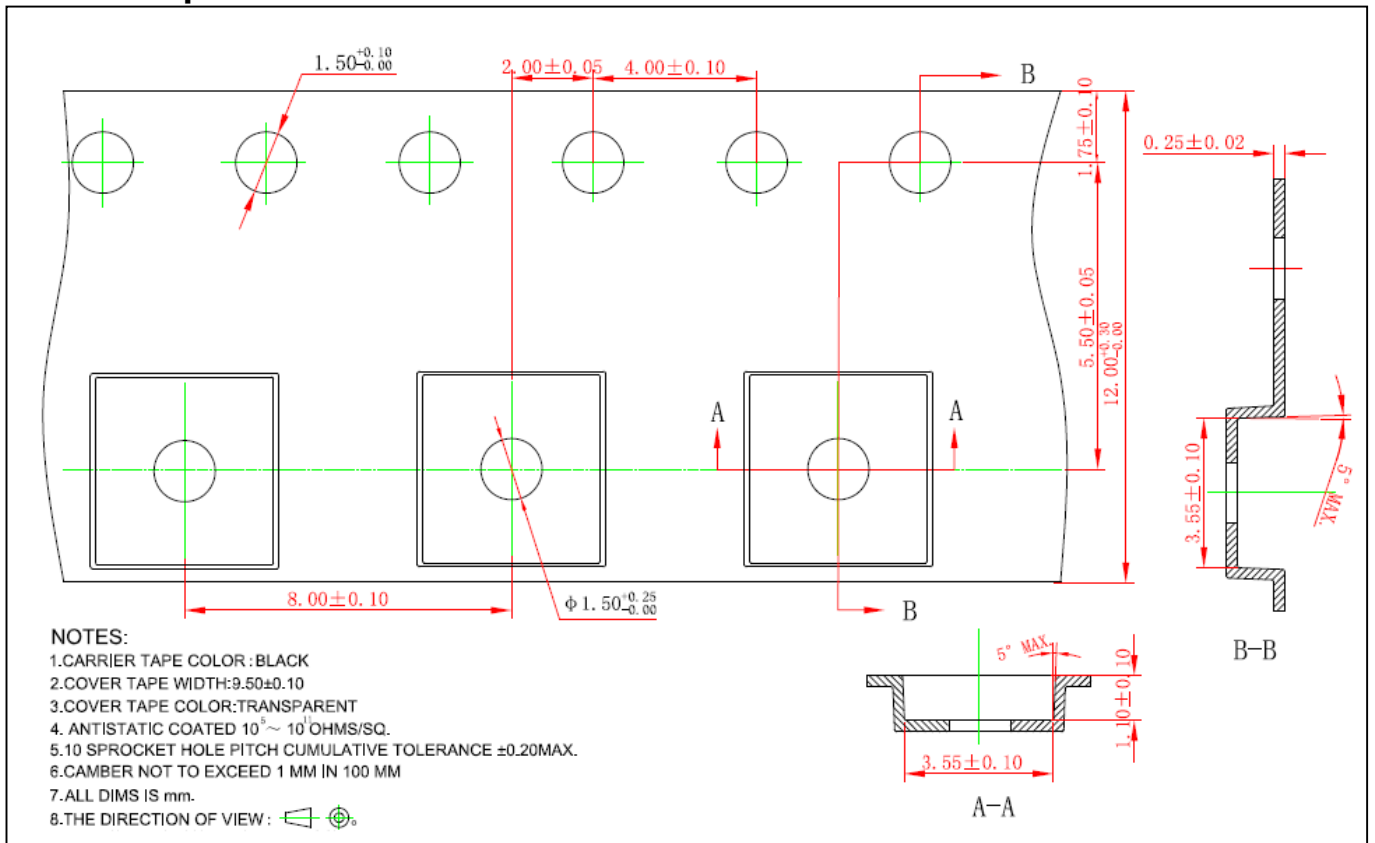

Recommended wave soldering condition

| | | |
|-----------------|------------------|-----------------|
| Product | Peak Temperature | Soldering Time |
| Pb-free devices | 260 +0/-5 °C | 5 +1/-1 seconds |

Recommended temperature profile for IR reflow

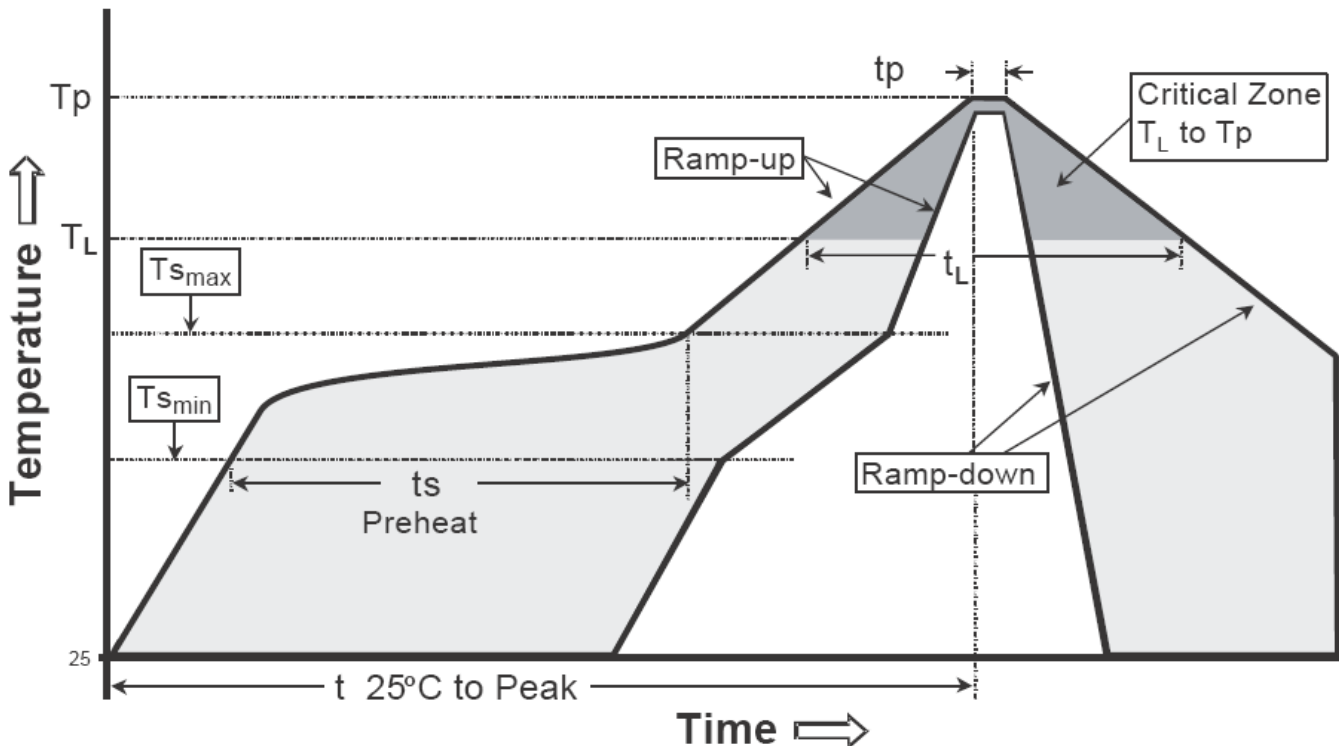

| Profile feature | Sn-Pb eutectic Assembly | Pb-free Assembly |
|-------------------------------------------------------------|-------------------------|------------------|
| Average ramp-up rate (T _{smax} to T _p) | 3°C/second max. | 3°C/second max. |
| Preheat | | |
| -Temperature Min(T _{s min}) | 100°C | 150°C |
| -Temperature Max(T _{s max}) | 150°C | 200°C |
| -Time(t _{s min} to t _{s max}) | 60-120 seconds | 60-180 seconds |
| Time maintained above: | | |
| -Temperature (T _L) | 183°C | 217°C |
| - Time (t _L) | 60-150 seconds | 60-150 seconds |
| Peak Temperature(T _p) | 240 +0/-5 °C | 260 +0/-5 °C |
| Time within 5°C of actual peak temperature(tp) | 10-30 seconds | 20-40 seconds |
| Ramp down rate | 6°C/second max. | 6°C/second max. |
| Time 25 °C to peak temperature | 6 minutes max. | 8 minutes max. |

Note : All temperatures refer to topside of the package, measured on the package body surface.

DFN3x3 Dimension

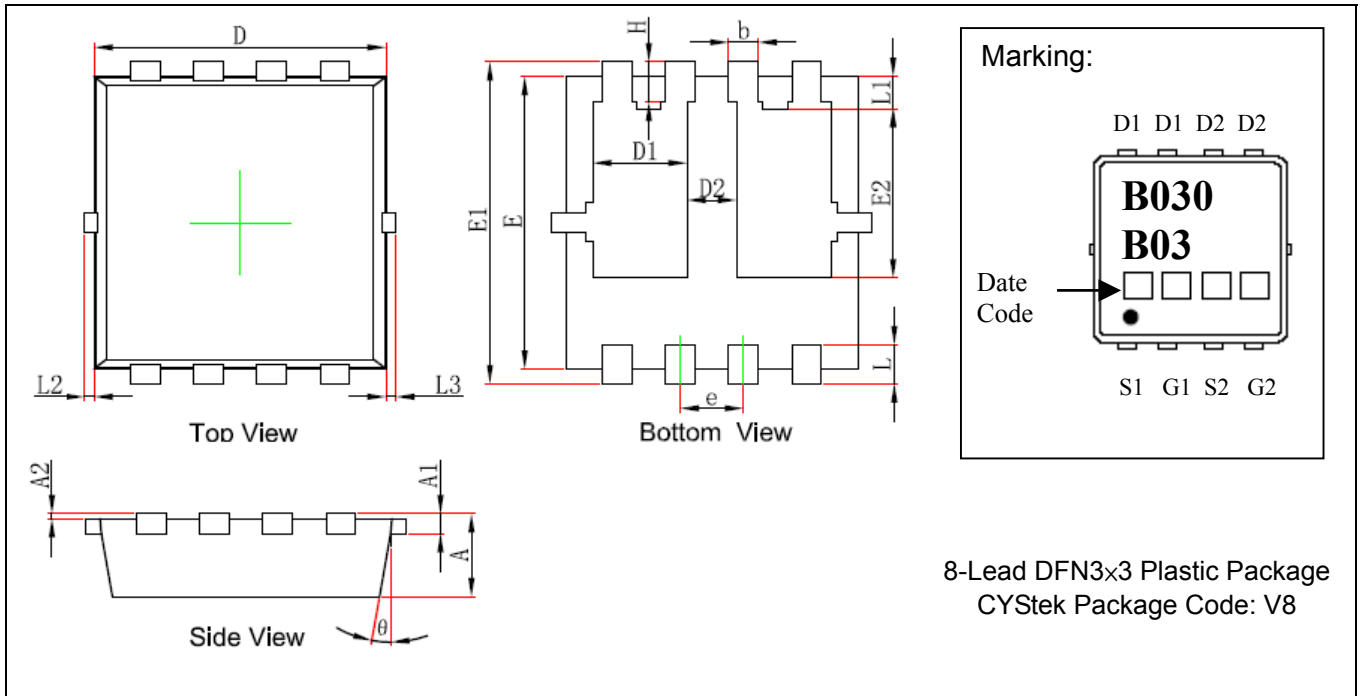

| DIM | Millimeters | | Inches | | DIM | Millimeters | | Inches | |
|-----|-------------|-------|--------|-------|-----|-------------|-------|--------|-------|
| | Min. | Max. | Min. | Max. | | Min. | Max. | Min. | Max. |
| A | 0.650 | 0.850 | 0.026 | 0.033 | b | 0.200 | 0.400 | 0.008 | 0.016 |
| A1 | 0.152 | REF | 0.006 | REF | e | 0.550 | 0.750 | 0.022 | 0.030 |
| A2 | 0.000 | 0.050 | 0.000 | 0.002 | L | 0.300 | 0.500 | 0.012 | 0.020 |
| D | 2.900 | 3.100 | 0.114 | 0.122 | L1 | 0.180 | 0.480 | 0.007 | 0.019 |
| D1 | 0.935 | 1.135 | 0.037 | 0.045 | L2 | 0.000 | 0.100 | 0.000 | 0.004 |
| D2 | 0.280 | 0.480 | 0.011 | 0.019 | L3 | 0.000 | 0.100 | 0.000 | 0.004 |
| E | 2.900 | 3.100 | 0.114 | 0.122 | H | 0.315 | 0.515 | 0.012 | 0.020 |
| E1 | 3.150 | 3.450 | 0.124 | 0.136 | θ | 9° | 13° | 9° | 13° |
| E2 | 1.535 | 1.935 | 0.060 | 0.076 | | | | | |

Notes: 1.Controlling dimension: millimeters.
 2.Maximum lead thickness includes lead finish thickness, and minimum lead thickness is the minimum thickness of base material.
 3.If there is any question with packing specification or packing method, please contact your local CYStek sales office.

Material:

- Lead: pure tin plated.
- Mold Compound: Epoxy resin family, flammability solid burning class: UL94V-0.

Important Notice:

- All rights are reserved. Reproduction in whole or in part is prohibited without the prior written approval of CYStek.
- CYStek reserves the right to make changes to its products without notice.
- CYStek **semiconductor products are not warranted to be suitable for use in Life-Support Applications, or systems.**
- CYStek assumes no liability for any consequence of customer product design, infringement of patents, or application assistance.