

# N-Channel Enhancement Mode Power MOSFET

## MTB028N10RNCQ8

|  |                    |
|--|--------------------|
| <b>BV<sub>DSS</sub></b>  | <b>100V</b>        |
| <b>I<sub>D</sub> @ T<sub>A</sub>=25°C, V<sub>GS</sub>=10V</b>    | <b>6.6A</b>        |
| <b>R<sub>DS(ON)</sub>@ V<sub>GS</sub>=10V, I<sub>D</sub>=4A</b>  | <b>22 mΩ (typ)</b> |
| <b>R<sub>DS(ON)</sub>@ V<sub>GS</sub>=4.5V, I<sub>D</sub>=3A</b> | <b>26 mΩ (typ)</b> |

### Features

- Single Drive Requirement
- Low On-resistance
- Fast Switching Characteristic
- Repetitive Avalanche Rated
- Pb-free & Halogen-free package

### Symbol

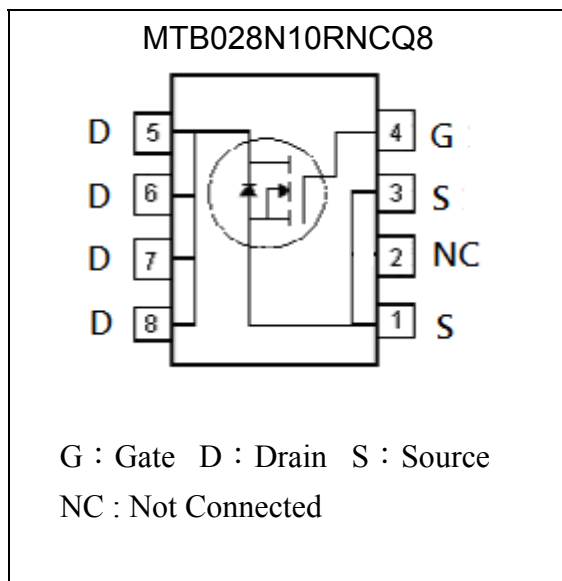

### Outline

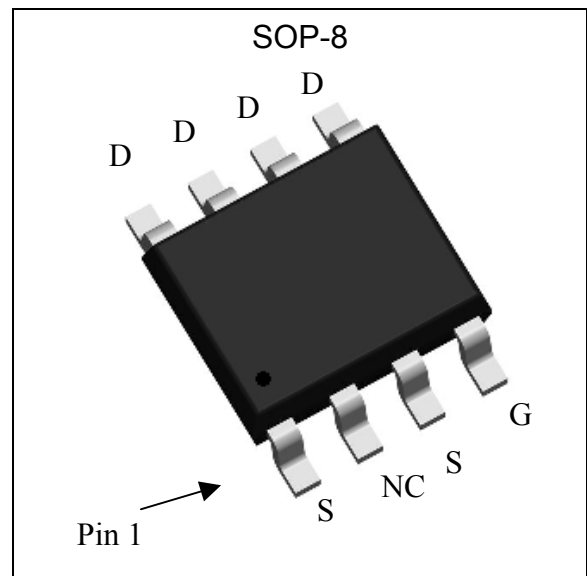

### Ordering Information

| Device                | Package  | Shipping               |
|-----------------------|--|------------------------|
| MTB028N10RNCQ8-0-T3-G | SOP-8<br>(RoHS compliant & Halogen-free package) | 2500 pcs / Tape & Reel |

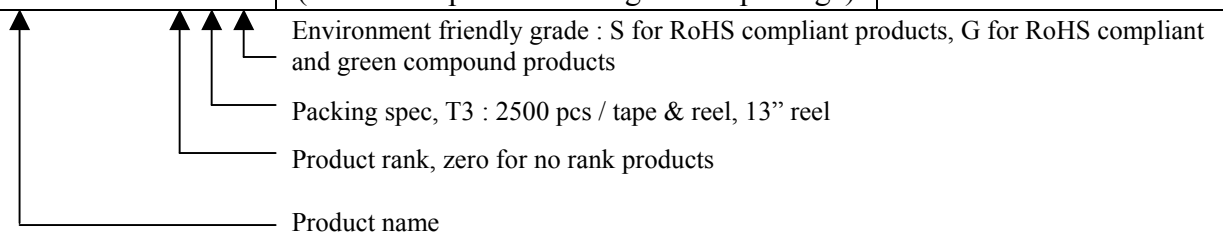



**Absolute Maximum Ratings** (Tc=25°C, unless otherwise noted)

| Parameter   | Symbol                            | Limits                | Unit |   |
|---|-----------------------------------|-----------------------|------|---|
| Drain-Source Voltage  | V <sub>DS</sub>                   | 100                   | V    |   |
| Gate-Source Voltage   | V <sub>GS</sub>                   | ±20                   |      |   |
| Continuous Drain Current @ T <sub>A</sub> =25°C, V <sub>GS</sub> =10V | I <sub>D</sub>                    | 6.6                   | A    |   |
| Continuous Drain Current @ T <sub>A</sub> =70°C, V <sub>GS</sub> =10V |                                   | 5.3                   |      |   |
| Pulsed Drain Current  | I <sub>DM</sub>                   | 30 *1                 |      |   |
| Avalanche Current @ L=0.1mH   | I <sub>AS</sub>                   | 30                    |      |   |
| Avalanche Energy @ L=1mH, I <sub>D</sub> =16A, V <sub>DD</sub> =25V   | E <sub>AS</sub>                   | 128 *3                | mJ   |   |
| Repetitive Avalanche Energy @ L=0.05mH                                | E <sub>AR</sub>                   | 1.6 *2                |      |   |
| Total Power Dissipation   | P <sub>D</sub>                    | T <sub>A</sub> =25 °C | 3.1  | W |
|   |                                   | T <sub>A</sub> =70 °C | 2    |   |
| Operating Junction and Storage Temperature                            | T <sub>j</sub> , T <sub>stg</sub> | -55~+150              | °C   |   |

Note : \*1. Pulse width limited by maximum junction temperature  
 \*2. Duty cycle ≤ 1%  
 \*3. 100% tested by conditions of L=0.5mH, I<sub>AS</sub>=10A, V<sub>GS</sub>=10V, V<sub>DD</sub>=25V

**Thermal Data**

| Parameter                                      | Symbol           | Value | Unit |
|--|------------------|-------|------|
| Thermal Resistance, Junction-to-case           | R <sub>θJC</sub> | 20    | °C/W |
| Thermal Resistance, Junction-to-ambient (Note) | R <sub>θJA</sub> | 40    |      |

Note : 40°C / W when mounted on a 1 in<sup>2</sup> pad of 2 oz copper, t≤10s; 125°C/W when mounted on minimum pad.

**Characteristics (Tc=25°C, unless otherwise specified)**

| Symbol               | Min. | Typ. | Max. | Unit | Test Conditions  |
|----------------------|------|------|------|------|--|
| <b>Static</b>        |      |      |      |      |  |
| BV <sub>DSS</sub>    | 100  | -    | -    | V    | V <sub>GS</sub> =0V, I <sub>D</sub> =250μA                       |
| V <sub>GS(th)</sub>  | 1.2  | -    | 2.7  |      | V <sub>DS</sub> = V <sub>GS</sub> , I <sub>D</sub> =250μA        |
| G <sub>FS</sub>      | -    | 12.7 | -    | S    | V <sub>DS</sub> =10V, I <sub>D</sub> =5A                         |
| I <sub>GSS</sub>     | -    | -    | ±100 | nA   | V <sub>GS</sub> =±20V  |
| I <sub>DSS</sub>     | -    | -    | 1    | μA   | V <sub>DS</sub> =80V, V <sub>GS</sub> =0V                        |
|                      | -    | -    | 25   |      | V <sub>DS</sub> =80V, V <sub>GS</sub> =0V, T <sub>j</sub> =125°C |
| *R <sub>DS(ON)</sub> | -    | 22   | 28   | mΩ   | V <sub>GS</sub> =10V, I <sub>D</sub> =4A                         |
|                      | -    | 26   | 35   |      | V <sub>GS</sub> =4.5V, I <sub>D</sub> =3A                        |
| <b>Dynamic</b>       |      |      |      |      |  |
| Q <sub>g</sub> *1,2  | -    | 27.8 | -    | nC   | V <sub>DS</sub> =80V, V <sub>GS</sub> =10V, I <sub>D</sub> =4A   |
| Q <sub>gs</sub> *1,2 | -    | 4    | -    |      |  |
| Q <sub>gd</sub> *1,2 | -    | 4.9  | -    |      |  |
| C <sub>iss</sub>     | -    | 1370 | -    | pF   | V <sub>DS</sub> =50V, V <sub>GS</sub> =0V, f=1MHz                |
| C <sub>oss</sub>     | -    | 91   | -    |      |  |
| C <sub>rss</sub>     | -    | 17   | -    |      |  |

**Characteristics (Cont. Tc=25°C, unless otherwise specified)**

| Symbol  | Min. | Typ. | Max. | Unit | Test Conditions   |
|---|------|------|------|------|---|
| <b>Dynamic</b>  |      |      |      |      |   |
| t <sub>d(ON)</sub> *1, 2                              | -    | 10.8 | -    | ns   | V <sub>DS</sub> =50V, I <sub>D</sub> =1A, V <sub>GS</sub> =10V, R <sub>GS</sub> =6Ω |
| t <sub>r</sub> *1, 2                                  | -    | 17.2 | -    |      |   |
| t <sub>d(OFF)</sub> *1, 2                             | -    | 50.6 | -    |      |   |
| t <sub>f</sub> *1, 2                                  | -    | 15.2 | -    |      |   |
| R <sub>g</sub>  | -    | 1.8  | -    | Ω    | f=1MHz  |
| <b>Source-Drain Diode Ratings and Characteristics</b> |      |      |      |      |   |
| I <sub>S</sub> *1                                     | -    | -    | 6.6  | A    |   |
| I <sub>SM</sub> *3                                    | -    | -    | 30   |      |   |
| V <sub>SD</sub> *1                                    | -    | 0.75 | 1.2  | V    | I <sub>S</sub> =2A, V <sub>GS</sub> =0V   |
| t <sub>rr</sub>                                       | -    | 21.7 | -    | ns   | I <sub>F</sub> =2A, dI <sub>F</sub> /dt=100A/μs                                     |
| Q <sub>rr</sub>                                       | -    | 21.5 | -    | nC   |   |

Note : \*1.Pulse Test : Pulse Width ≤300μs, Duty Cycle≤2%  
 \*2.Independent of operating temperature  
 \*3.Pulse width limited by maximum junction temperature.

**Recommended Soldering Footprint**

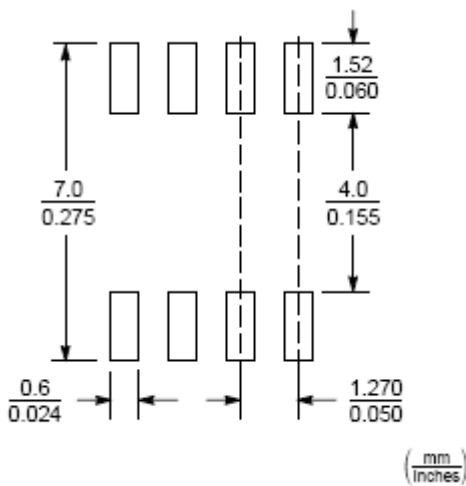



### Typical Characteristics

Typical Output Characteristics

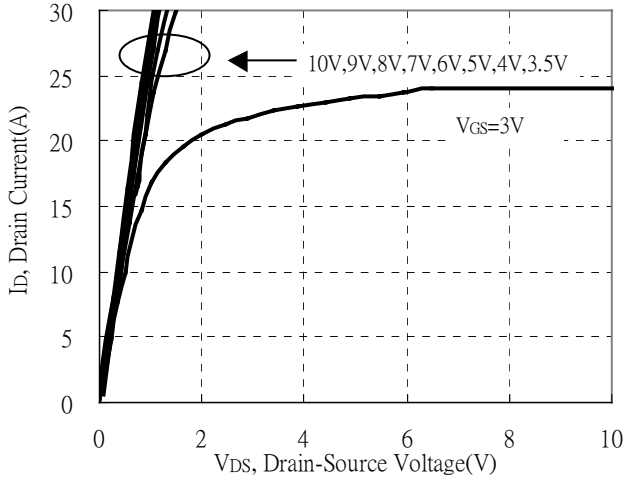

Brekdown Voltage vs Ambient Temperature

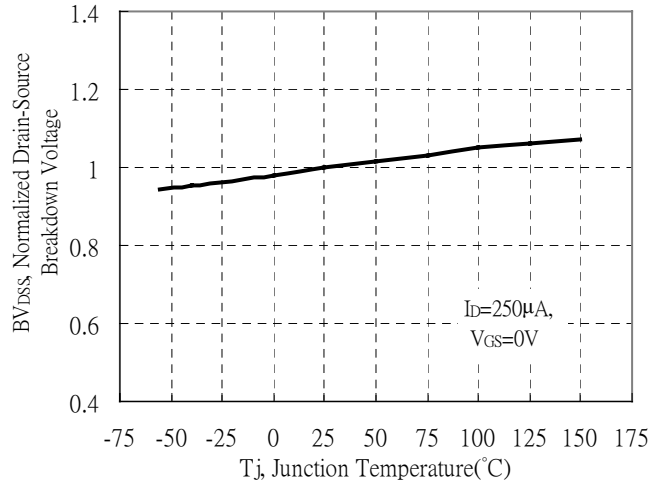

Static Drain-Source On-State resistance vs Drain Current

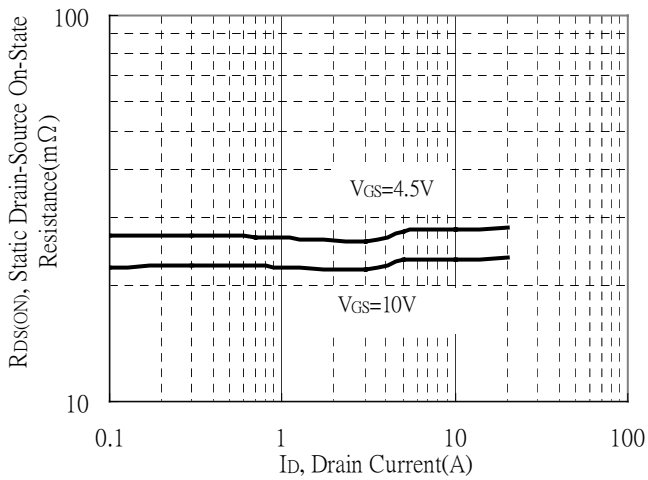

Reverse Drain Current vs Source-Drain Voltage

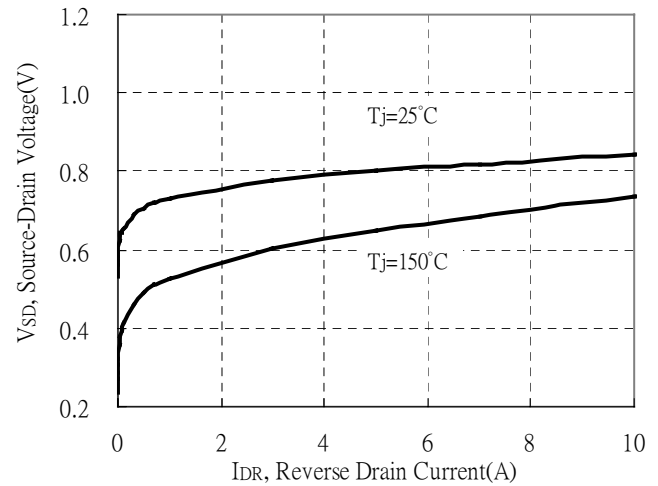

Static Drain-Source On-State Resistance vs Gate-Source Voltage

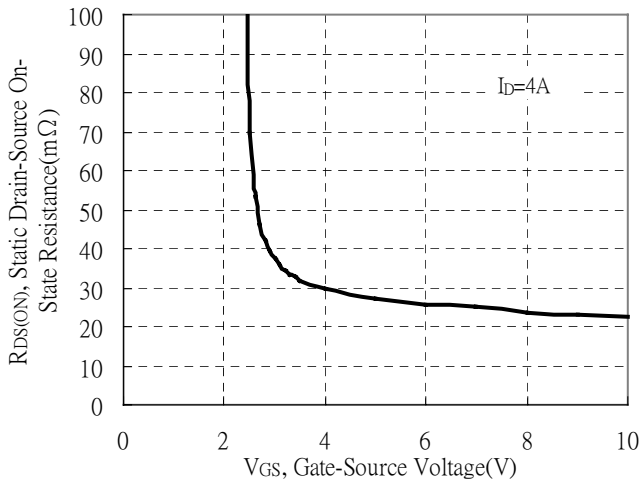

Drain-Source On-State Resistance vs Junction Temperature

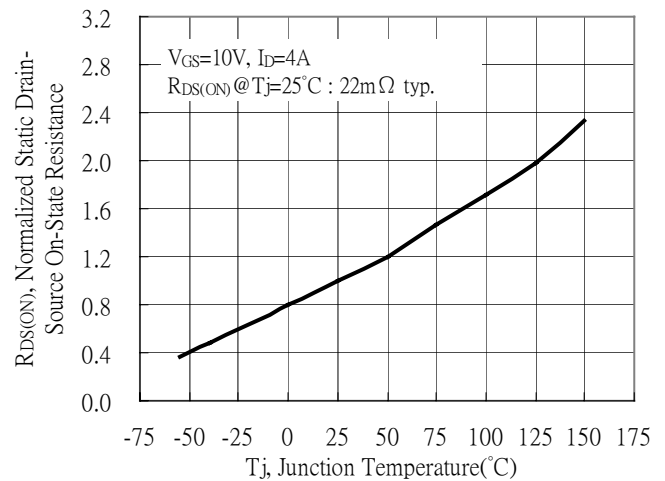

## Typical Characteristics(Cont.)

Capacitance vs Drain-to-Source Voltage

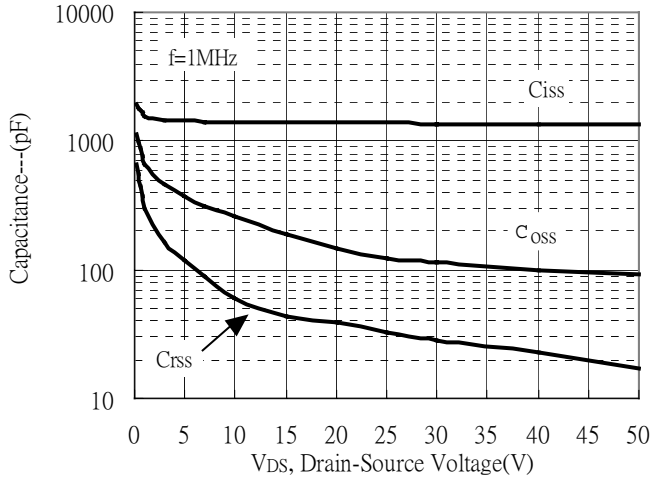

Threshold Voltage vs Junction Temperature

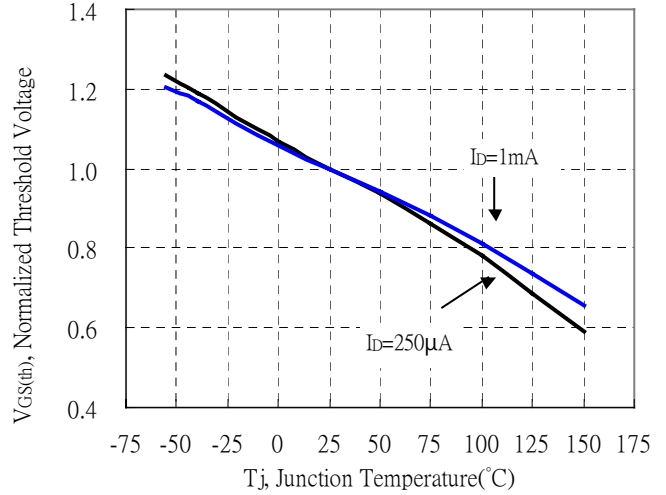

Forward Transfer Admittance vs Drain Current

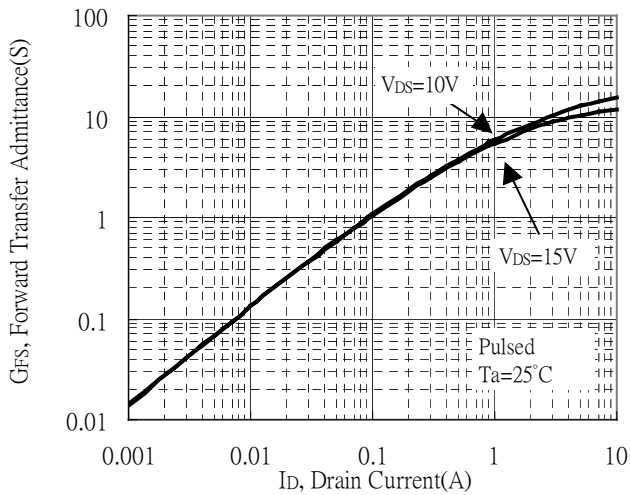

Gate Charge Characteristics

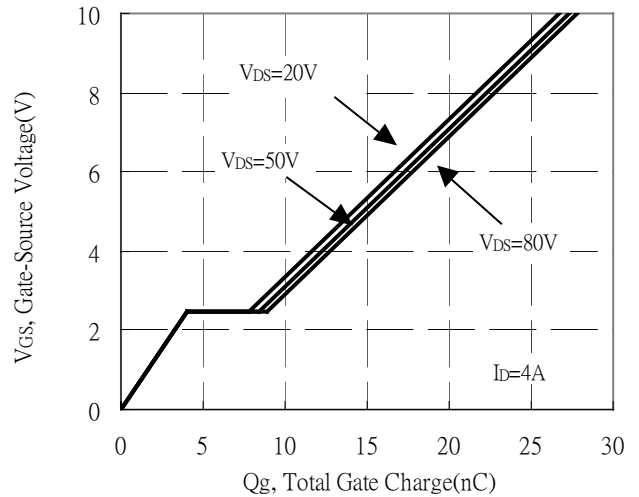

Maximum Safe Operating Area

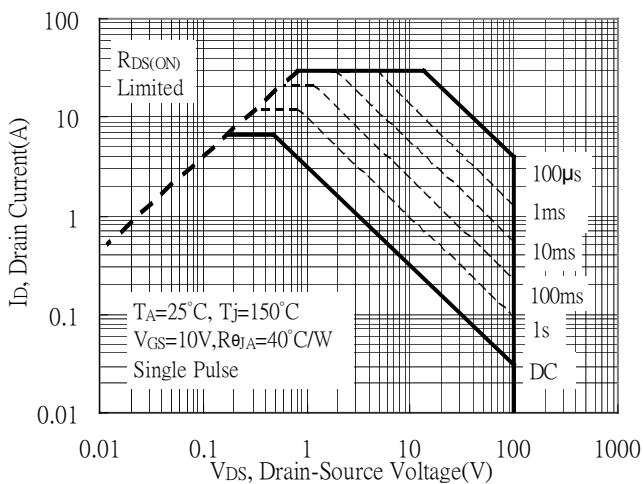

Maximum Drain Current vs Junction Temperature

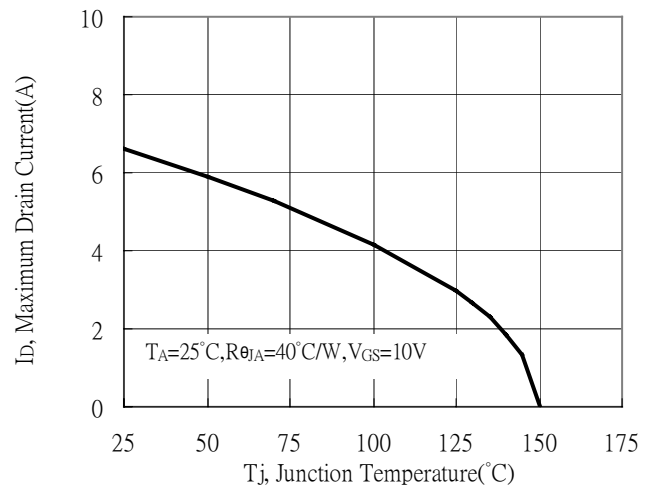



**Typical Characteristics(Cont.)**

Typical Transfer Characteristics

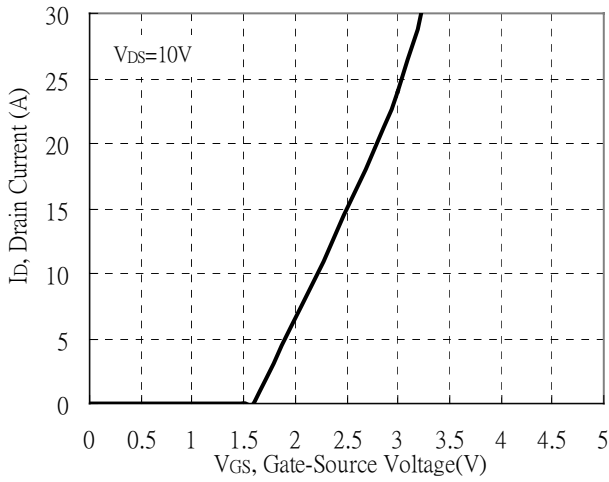

Single Pulse Power Rating, Junction to Ambient  
 (Note on page 2)

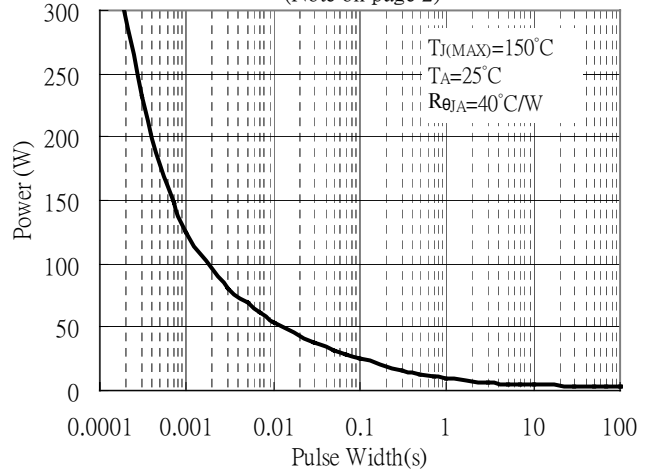

Transient Thermal Response Curves

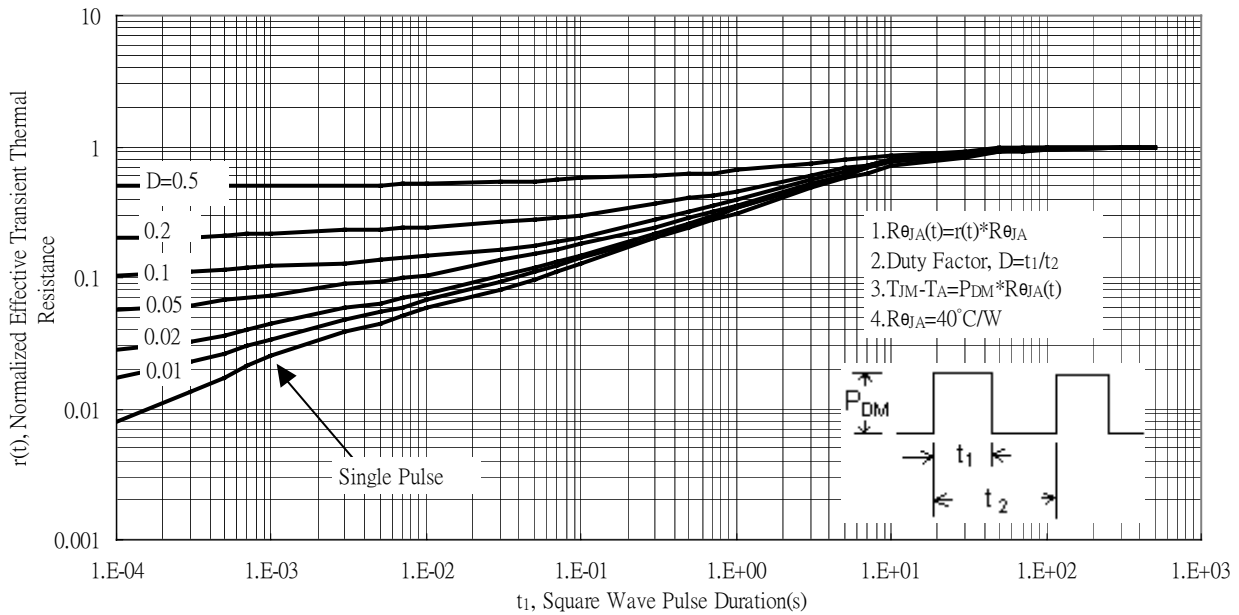

**Reel Dimension**

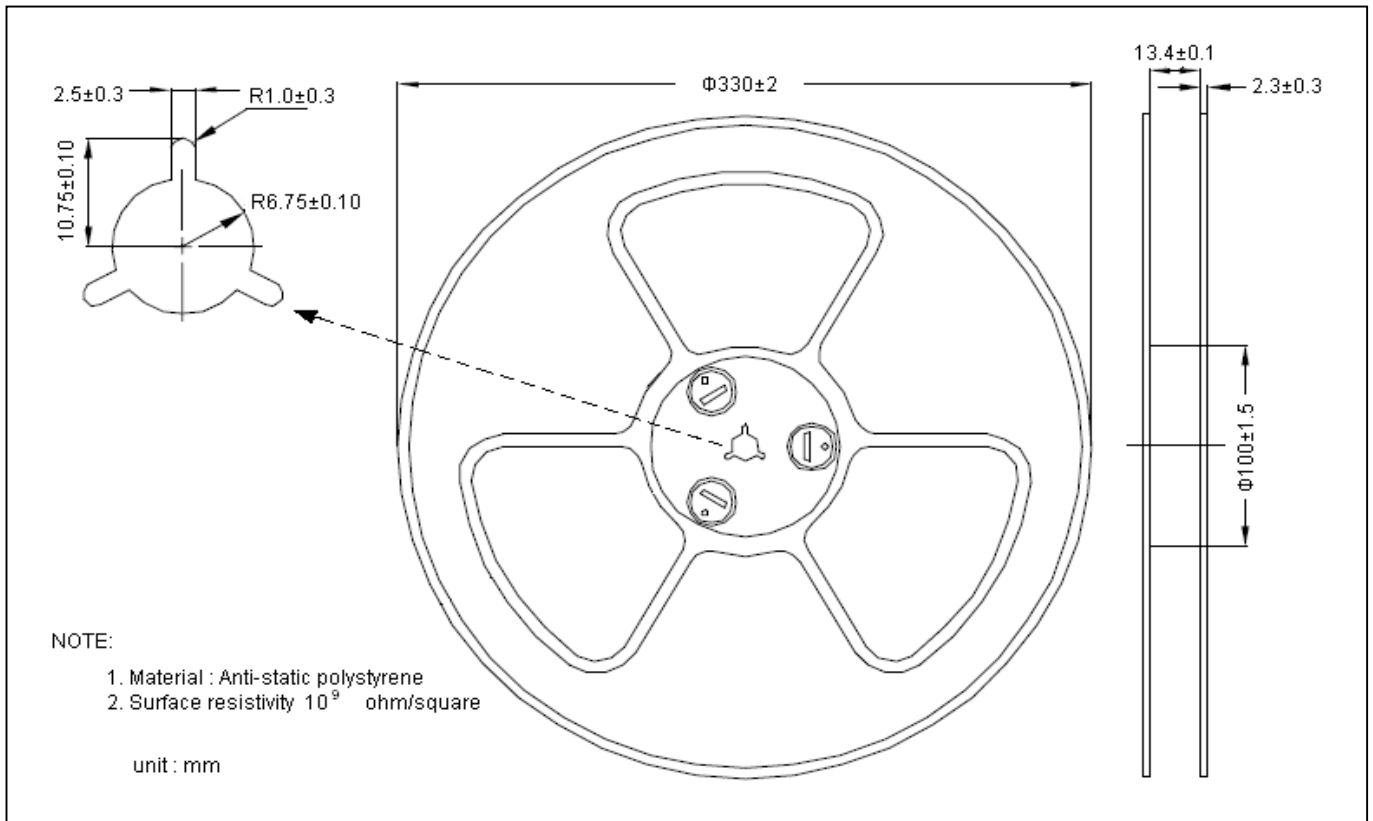

**Carrier Tape Dimension**

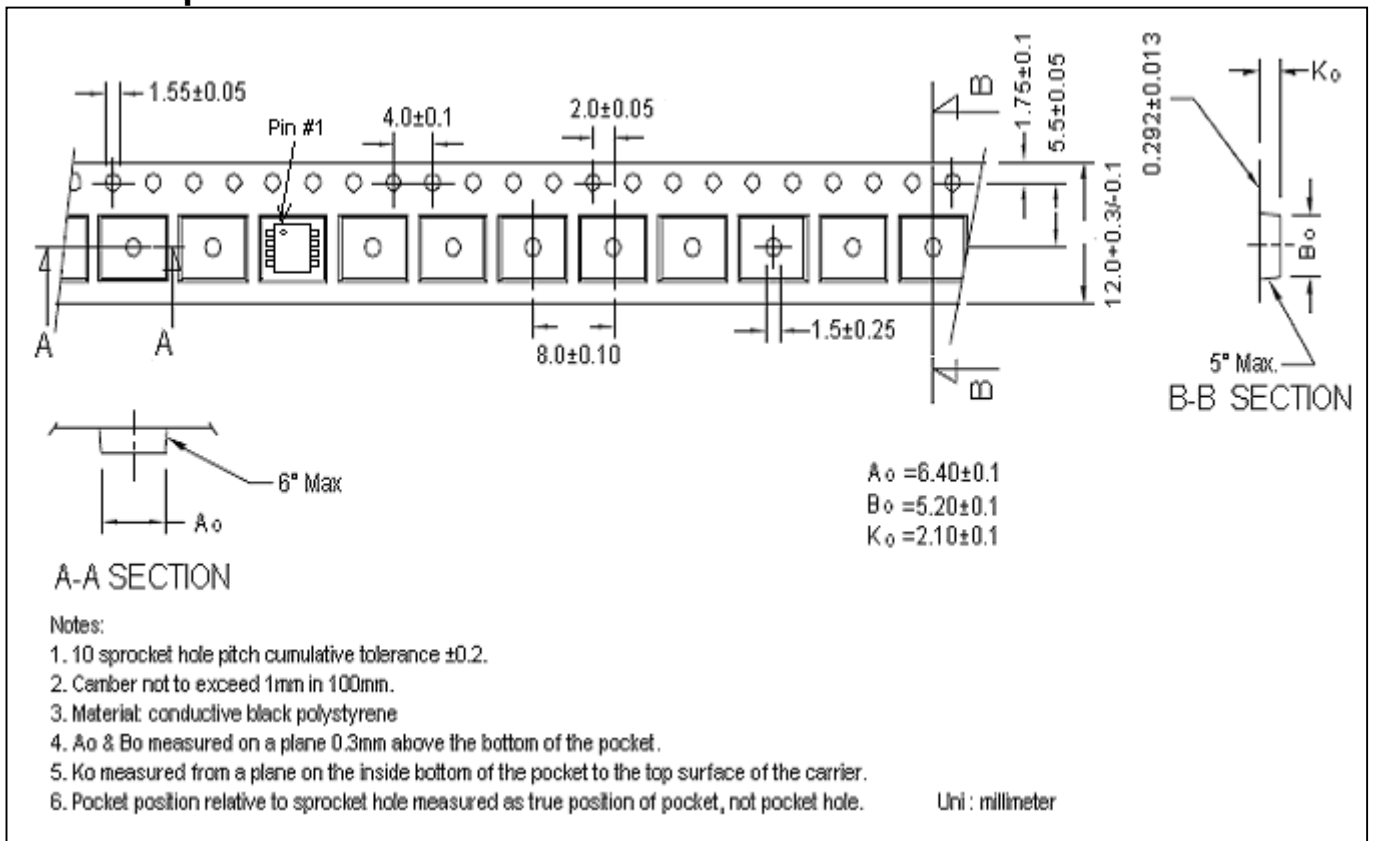

**Recommended wave soldering condition**

|                 |                  |                 |
|-----------------|------------------|-----------------|
| Product         | Peak Temperature | Soldering Time  |
| Pb-free devices | 260 +0/-5 °C     | 5 +1/-1 seconds |

**Recommended temperature profile for IR reflow**

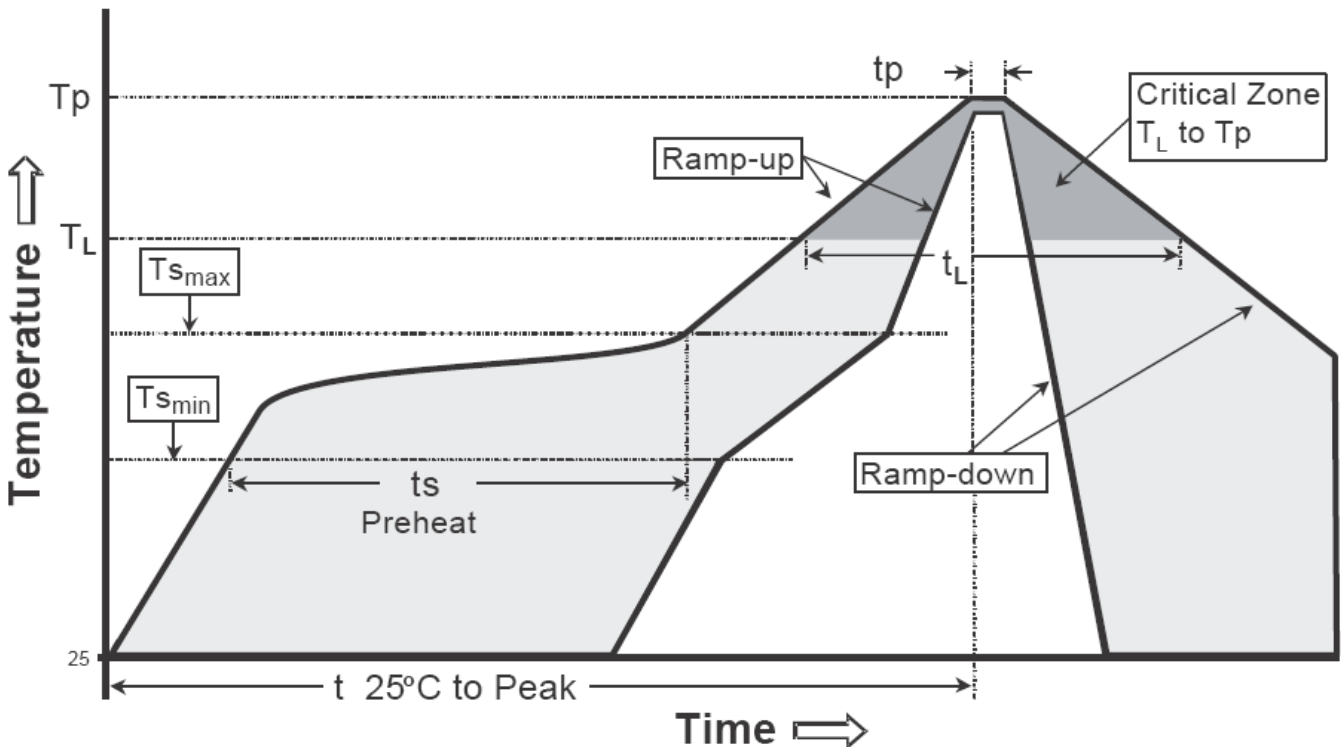

| Profile feature                                | Sn-Pb eutectic Assembly | Pb-free Assembly |
|--|-------------------------|------------------|
| Average ramp-up rate (Tsmax to Tp)             | 3°C/second max.         | 3°C/second max.  |
| Preheat  |                         |                  |
| -Temperature Min(Ts min)                       | 100°C                   | 150°C            |
| -Temperature Max(Ts max)                       | 150°C                   | 200°C            |
| -Time(ts min to ts max)                        | 60-120 seconds          | 60-180 seconds   |
| Time maintained above:                         |                         |                  |
| -Temperature (Tl)                              | 183°C                   | 217°C            |
| - Time (tL)                                    | 60-150 seconds          | 60-150 seconds   |
| Peak Temperature(Tp)                           | 240 +0/-5 °C            | 260 +0/-5 °C     |
| Time within 5°C of actual peak temperature(tp) | 10-30 seconds           | 20-40 seconds    |
| Ramp down rate                                 | 6°C/second max.         | 6°C/second max.  |
| Time 25 °C to peak temperature                 | 6 minutes max.          | 8 minutes max.   |

Note : All temperatures refer to topside of the package, measured on the package body surface.



**SOP-8 Dimension**

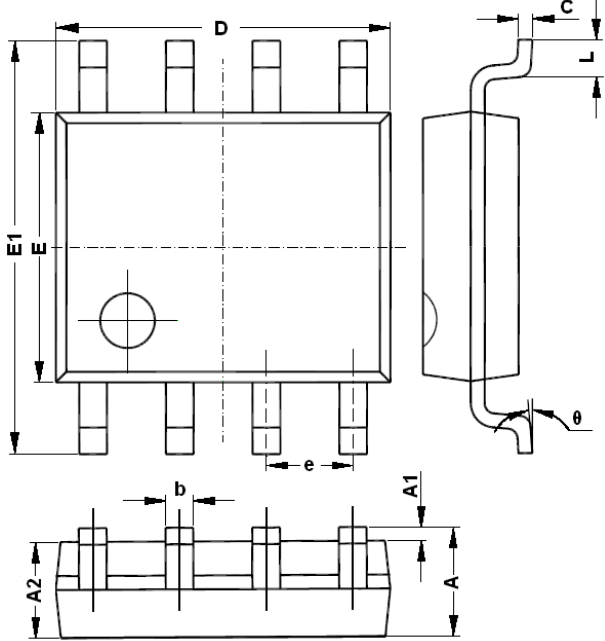

The diagram shows three views of an 8-lead SOP-8 package: a top view with dimensions D, E1, and E; a side view with dimensions c, L, and  $\theta$ ; and a bottom view with dimensions A1, A2, b, and A.

**Marking:**

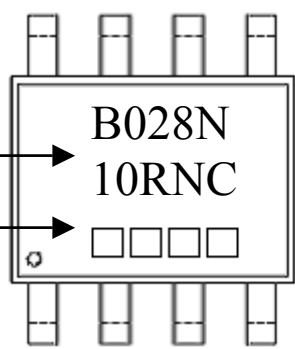

Device Name → B028N  
 10RNC

Date Code → □ □ □ □

Date Code(counting from left to right) :  
 1<sup>st</sup> code: year code, the last digit of Christian year  
 2<sup>nd</sup> code : month code, Jan→A, Feb→B, Mar→C, Apr→D  
                   May→E, Jun→F, Jul→G, Aug→H, Sep→J,  
                   Oct→K, Nov→L, Dec→M  
 3<sup>rd</sup> and 4<sup>th</sup> codes : production serial number, 01~99

**8-Lead SOP-8 Plastic Package**  
 CYStek Package Code: Q8

| DIM | Millimeters |       | Inches |       | DIM      | Millimeters |       | Inches |       |
|-----|-------------|-------|--------|-------|----------|-------------|-------|--------|-------|
|     | Min.        | Max.  | Min.   | Max.  |          | Min.        | Max.  | Min.   | Max.  |
| A   | 1.350       | 1.750 | 0.053  | 0.069 | E        | 3.800       | 4.000 | 0.150  | 0.157 |
| A1  | 0.100       | 0.250 | 0.004  | 0.010 | E1       | 5.800       | 6.200 | 0.228  | 0.244 |
| A2  | 1.350       | 1.550 | 0.053  | 0.061 | e        | 1.270       | (BSC) | 0.050  | (BSC) |
| b   | 0.330       | 0.510 | 0.013  | 0.020 | L        | 0.400       | 1.270 | 0.016  | 0.050 |
| c   | 0.170       | 0.250 | 0.006  | 0.010 | $\theta$ | 0           | 8°    | 0      | 8°    |
| D   | 4.700       | 5.100 | 0.185  | 0.200 |          |             |       |        |       |

**Notes:** 1. Controlling dimension: millimeters.  
 2. Maximum lead thickness includes lead finish thickness, and minimum lead thickness is the minimum thickness of base material.  
 3. If there is any question with packing specification or packing method, please contact your local CYStek sales office.

**Material:**

- Lead: Pure tin plated.
- Mold Compound: Epoxy resin family, flammability solid burning class: UL94V-0.

**Important Notice:**

- All rights are reserved. Reproduction in whole or in part is prohibited without the prior written approval of CYStek.
- CYStek reserves the right to make changes to its products without notice.
- CYStek **semiconductor products are not warranted to be suitable for use in Life-Support Applications, or systems.**
- CYStek assumes no liability for any consequence of customer product design, infringement of patents, or application assistance.