

N-Channel Enhancement Mode MOSFET

MTAK6C3

BV_{DSS}	60V	
$I_D @ V_{GS}=4.5V, T_A=25^\circ C$	215mA	
$R_{DS(on)(TYP)}$	$V_{GS}=4.5V, I_D=200mA$	1.3 Ω
	$V_{GS}=2.5V, I_D=100mA$	1.7 Ω

Description

- Low voltage drive(2.5V drive) makes this device ideal for portable equipment.
- The MOSFET elements are independent, eliminating mutual interference.
- Mounting cost and area can be cut in half.
- High speed switching
- ESD protected device, HBM $\geq 2kV$
- Pb-free lead plating & halogen-free package

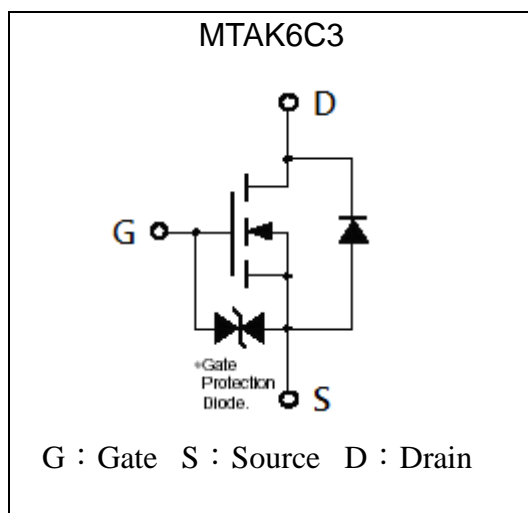
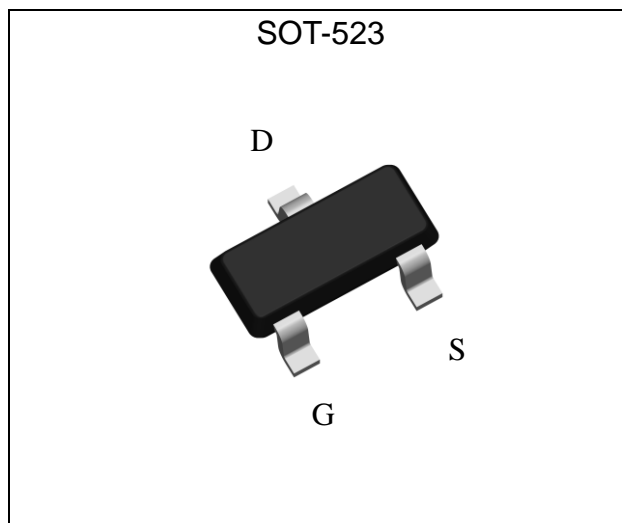
Symbol

Outline

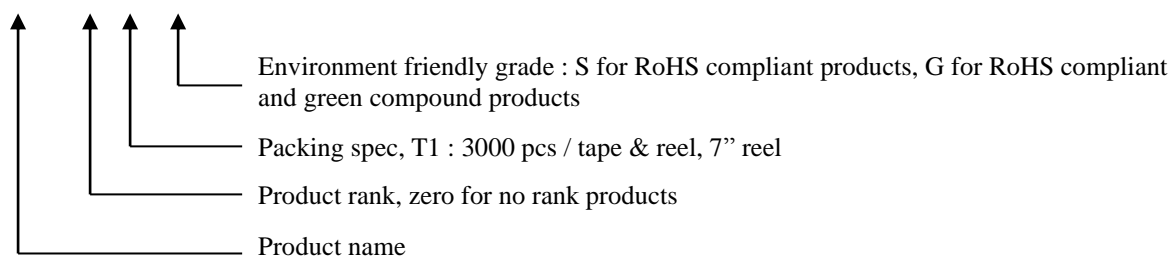
Ordering Information

Device	Package	Shipping
MTAK6C3-0-T1-G	SOT-523 (Pb-free lead plating & halogen-free package)	3000 pcs / Tape & Reel





Absolute Maximum Ratings (Ta=25°C)

Parameter	Symbol	Limits	Unit
Drain-Source Voltage	BV _{DSS}	60	V
Gate-Source Voltage	V _{GS}	±20	
Continuous Drain Current	I _D	215	mA
Pulsed Drain Current	I _{DM}	860 *1	
Total Power Dissipation	P _D	150 *2	mW
ESD susceptibility	V _{ESD}	2000 *3	V
Operating Junction and Storage Temperature Range	T _j ; T _{stg}	-55~+150	°C

Note : *1. Pulse Width ≤ 10μs, Duty cycle ≤ 1%
 *2. With each pin mounted on the recommended lands.
 *3. Human body model, 1.5kΩ in series with 100pF

Thermal Data

Parameter	Symbol	Value	Unit
Thermal Resistance, Junction to Ambient, max	*R _{θJA}	833	°C/W

Note : With each pin mounted on the recommended lands.

Electrical Characteristics (Ta=25°C)

Symbol	Min.	Typ.	Max.	Unit	Test Conditions
Static					
BV _{DSS}	60	-	-	V	V _{GS} =0V, I _D =250μA
V _{GS(th)}	0.5	-	1.5		I _D =250μA, V _{DS} =V _{GS}
I _{GSS}	-	-	±10	μA	V _{GS} =±16V, V _{DS} =0V
I _{DSS}	-	-	1		V _{DS} =60V, V _{GS} =0V
R _{DS(ON)}	-	1.3	3	Ω	V _{GS} =4.5V, I _D =200mA
	-	1.7	5.1		V _{GS} =2.5V, I _D =100mA
G _{FS}	100	322	-	mS	V _{DS} =5V, I _D =100mA
Dynamic					
C _{iss}	-	25.8	-	pF	V _{DS} =25V, V _{GS} =0V, f=1MHz
C _{oss}	-	8.6	-		
C _{rss}	-	7	-		
t _{d(on)}	-	3.1	-	ns	V _{DD} =30V, I _D =200mA, V _{GS} =10V, R _G =25Ω
t _r	-	15.1	-		
t _{d(off)}	-	11.4	-		
t _f	-	18	-		
*Q _g	-	1.6	-	nC	V _{DS} =30V, I _D =0.5A, V _{GS} =10V
*Q _{gs}	-	0.4	-		
*Q _{gd}	-	0.2	-		
R _g	-	3	-	Ω	f=1MHz
Source-Drain Diode					
*V _{SD}	-	0.79	1.2	V	V _{GS} =0V, I _S =100mA
*t _{rr}	-	8.3	-	ns	I _F =0.5A, dI _F /dt=100A/μs
*Q _{rr}	-	2.7	-	nC	

*Pulse Test : Pulse Width ≤ 300μs, Duty Cycle ≤ 2%

Typical Characteristics

Typical Output Characteristics

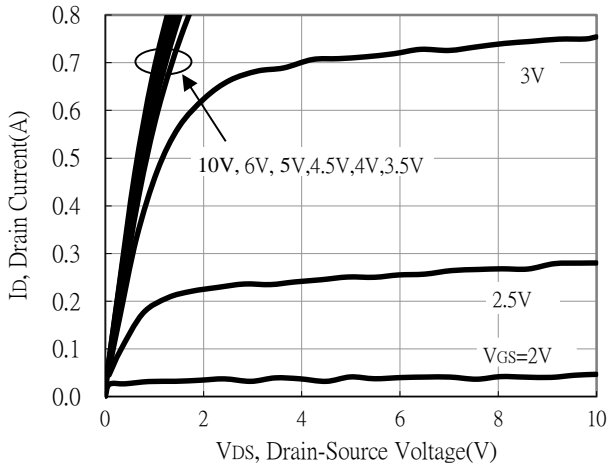

Typical Transfer Characteristics

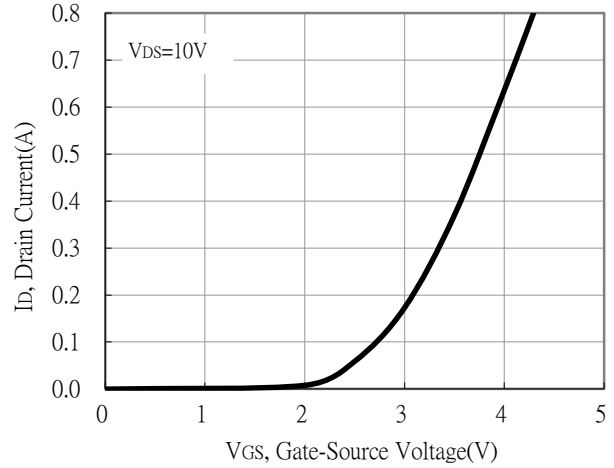

Static Drain-Source On-State resistance vs Drain Current

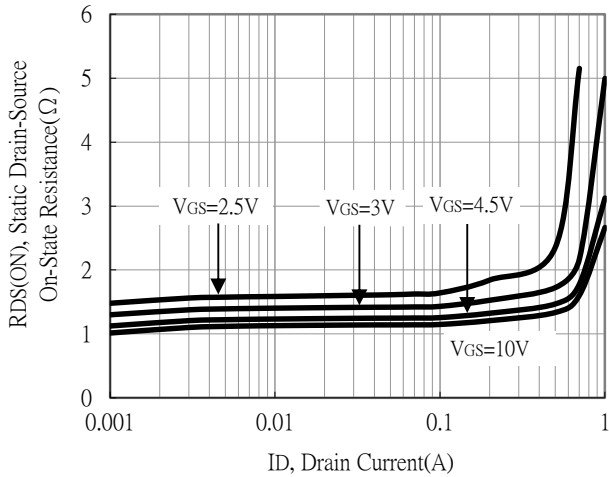

Reverse Drain Current vs Source-Drain Voltage

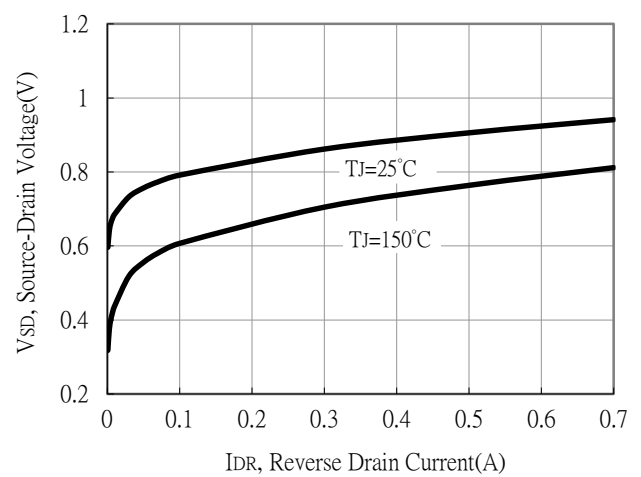

Static Drain-Source On-State Resistance vs Gate-Source Voltage

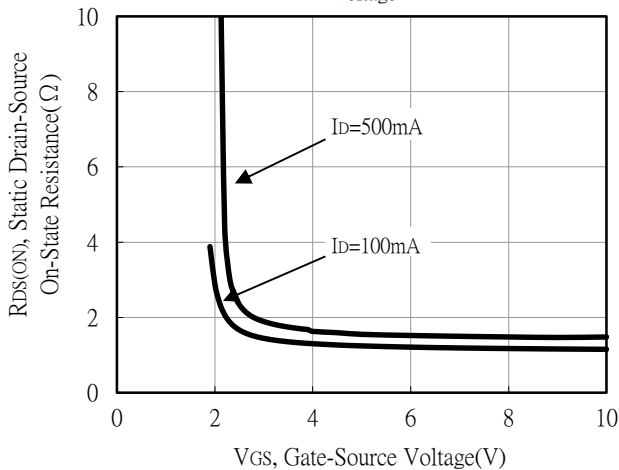

Drain-Source On-State Resistance vs Junction Temperature

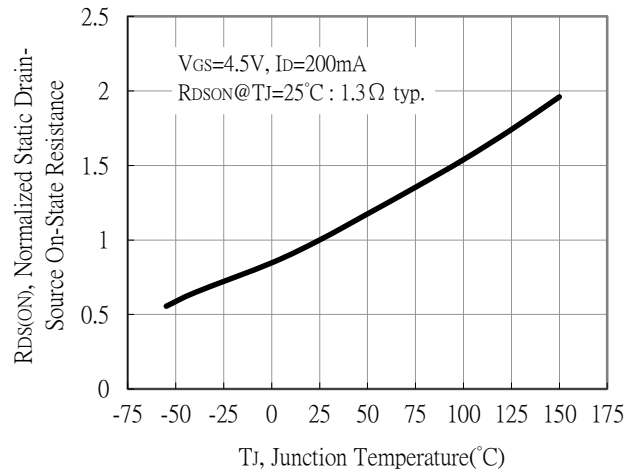

Typical Characteristics(Cont.)

Capacitance vs Drain-to-Source Voltage

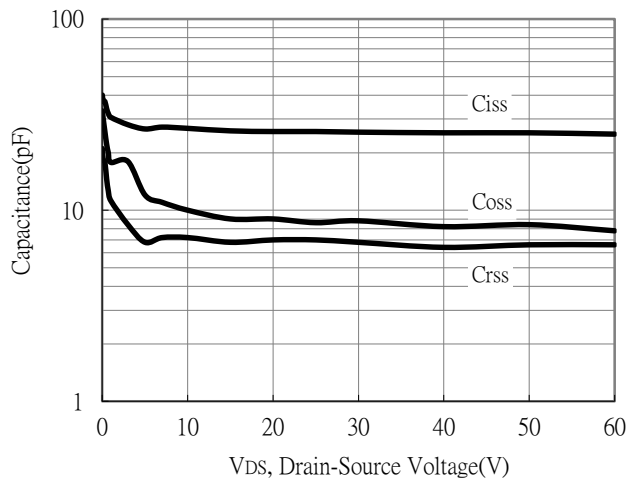

Threshold Voltage vs Junction Temperature

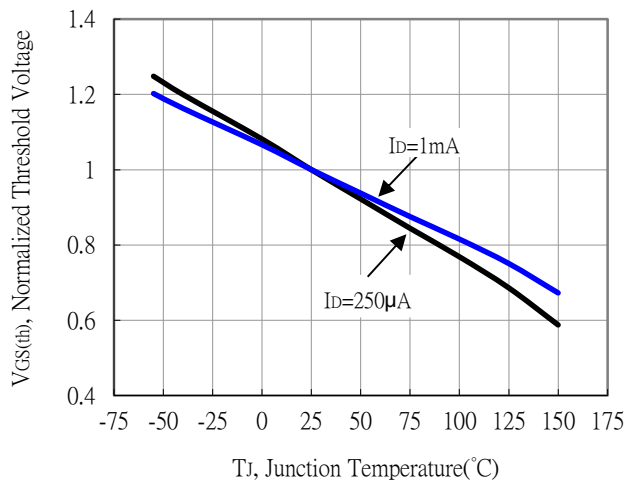

Forward Transfer Admittance vs Drain Current

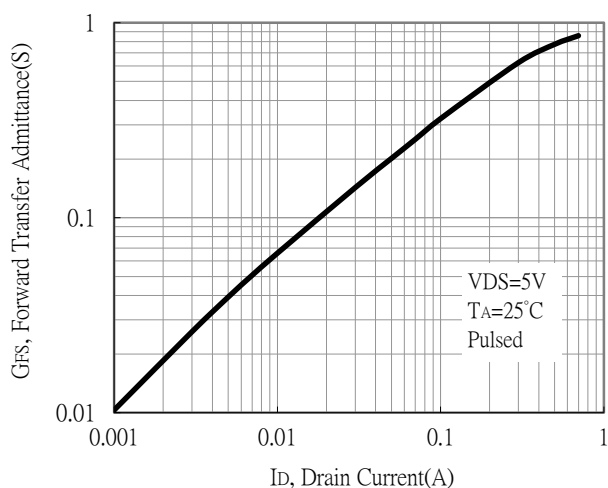

Breakdown Voltage vs Ambient Temperature

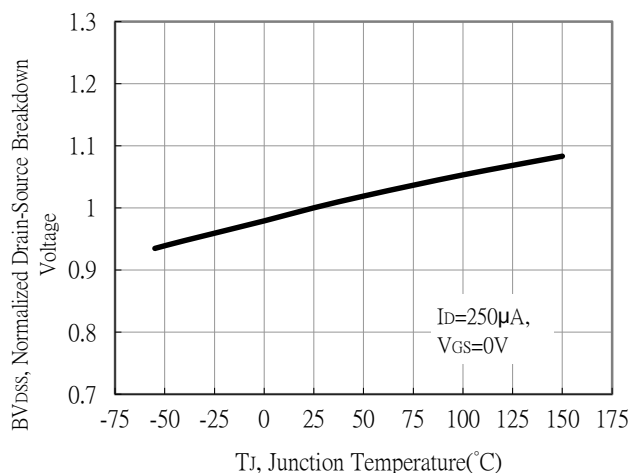

Power Derating Curve

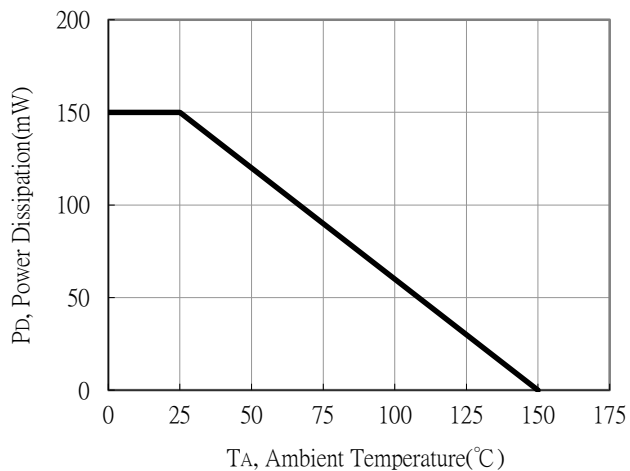

Maximum Drain Current vs Junction Temperature

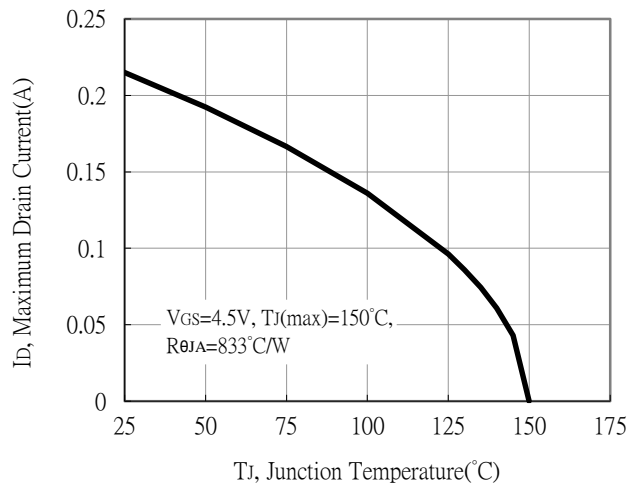

Typical Characteristics(Cont.)

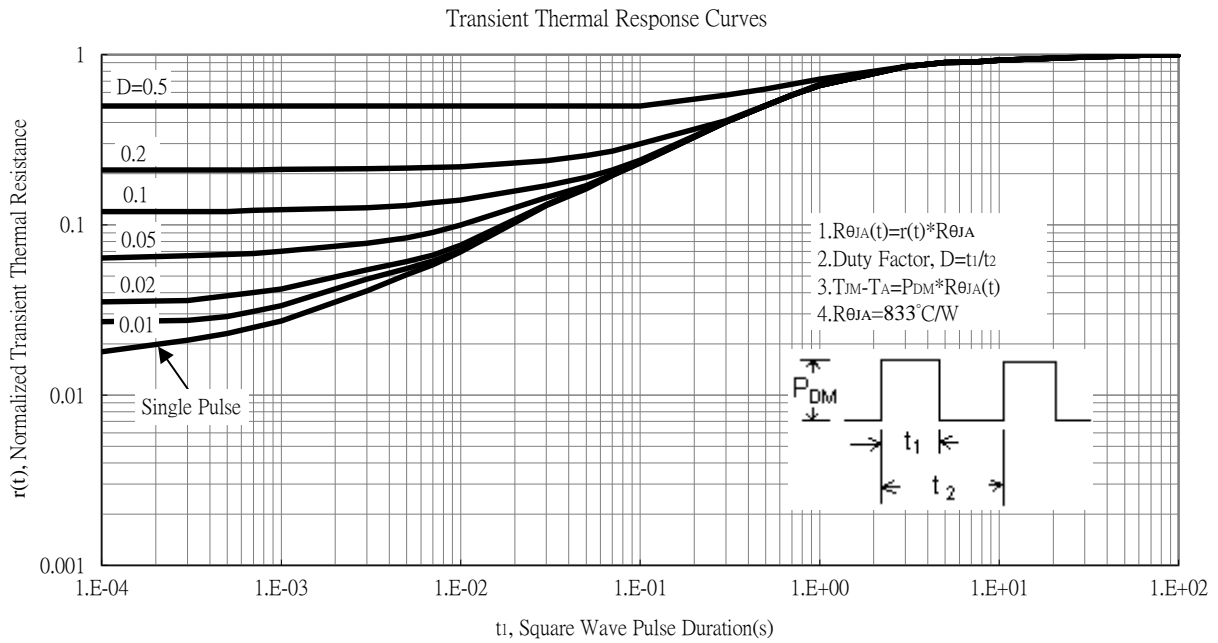
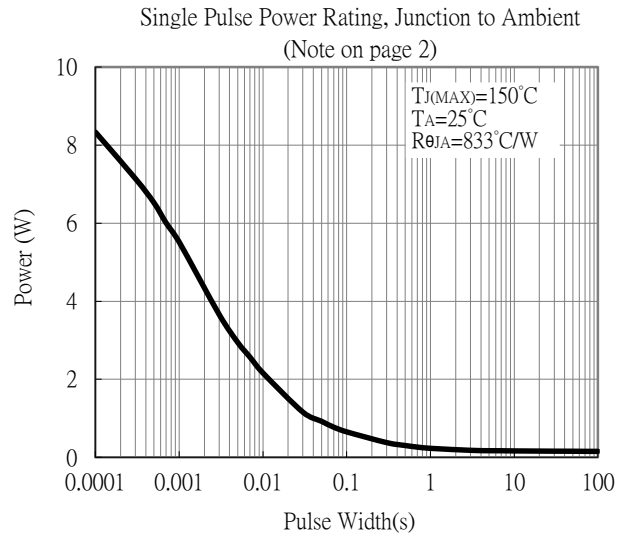
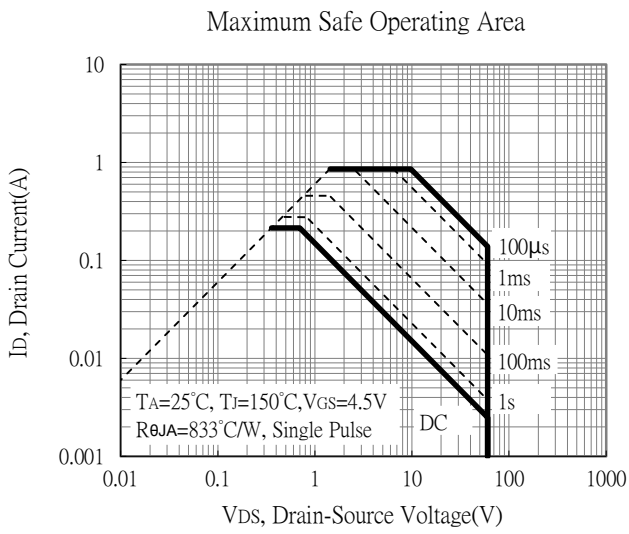

Recommended Soldering Footprint

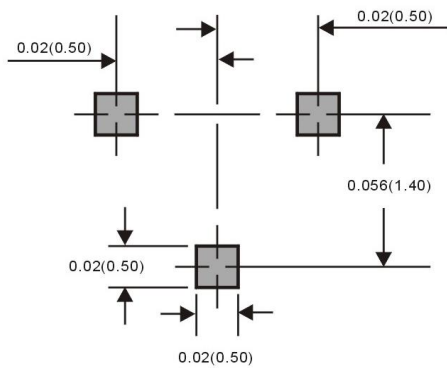

Reel Dimension

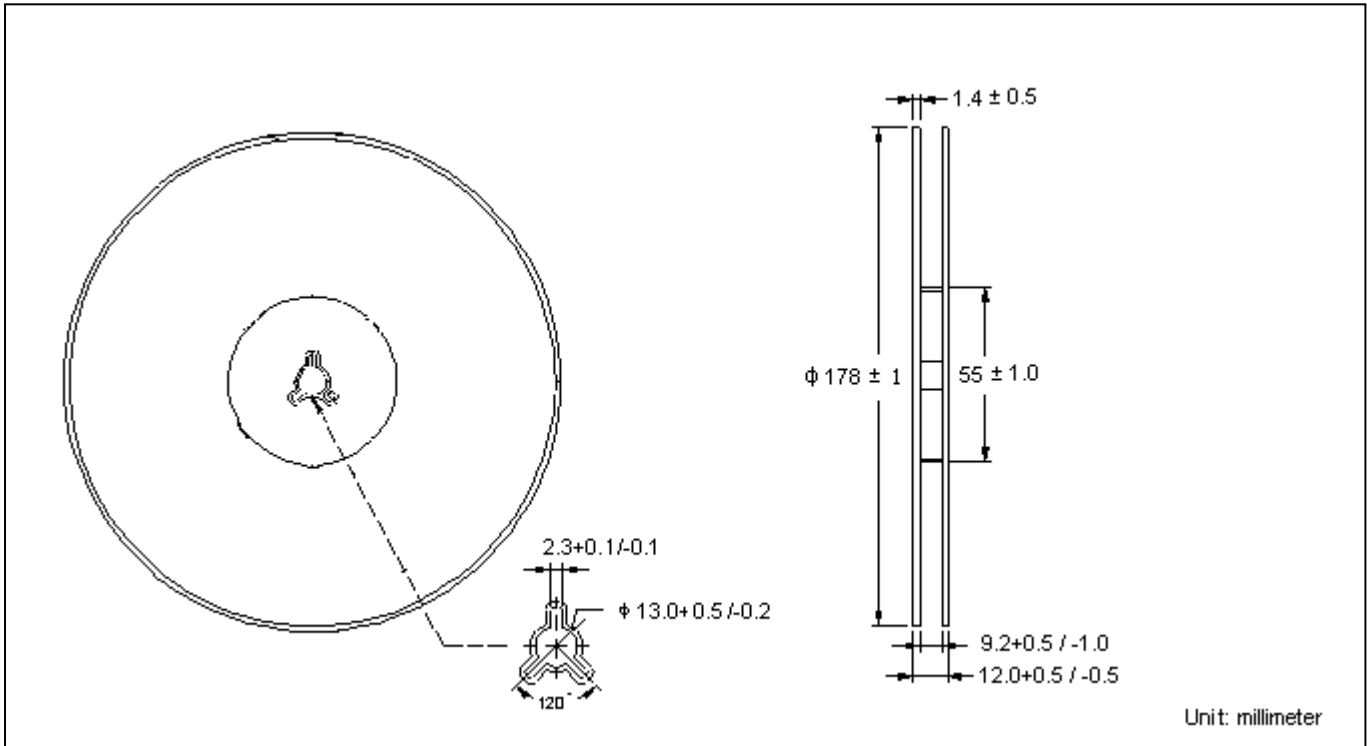

Carrier Tape Dimension

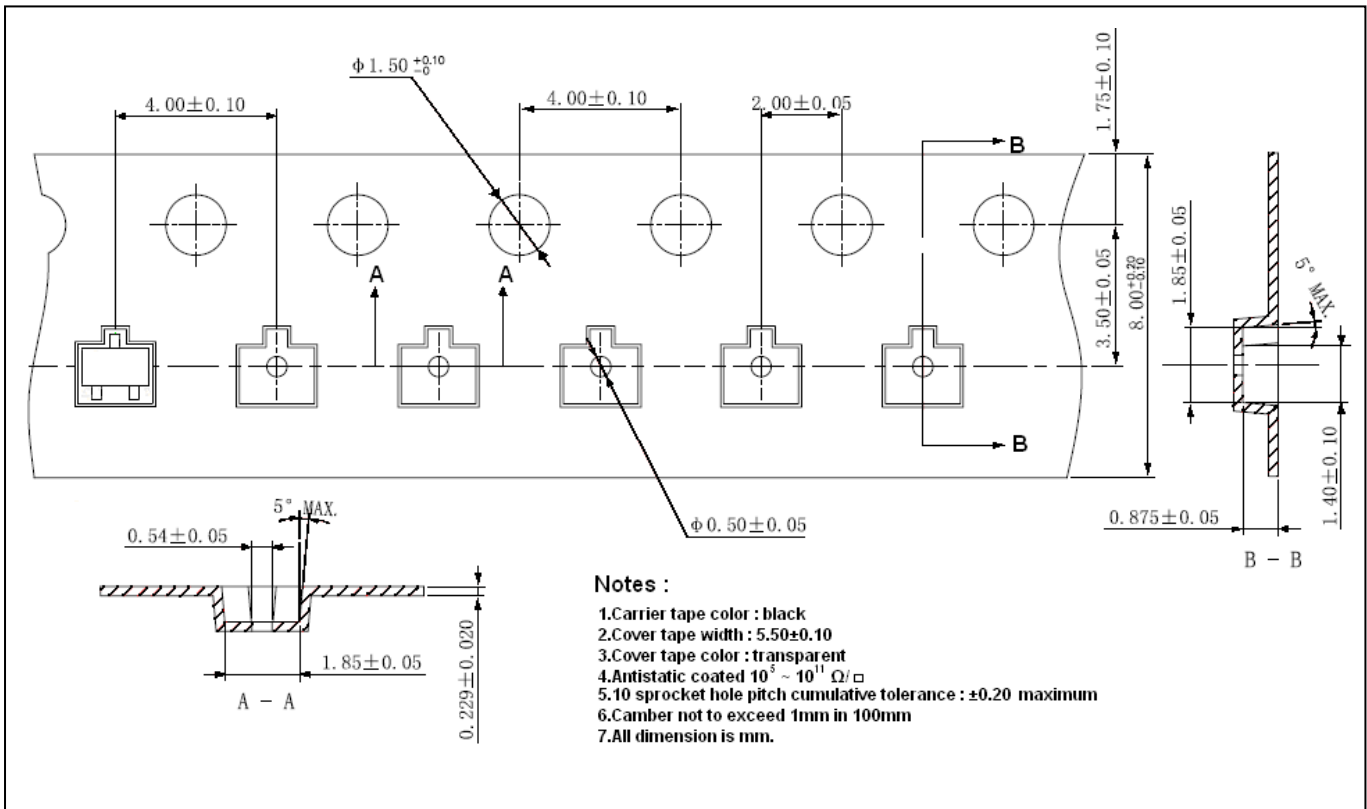

Recommended wave soldering condition

Product	Peak Temperature	Soldering Time
Pb-free devices	260 +0/-5 °C	5 +1/-1 seconds

Recommended temperature profile for IR reflow

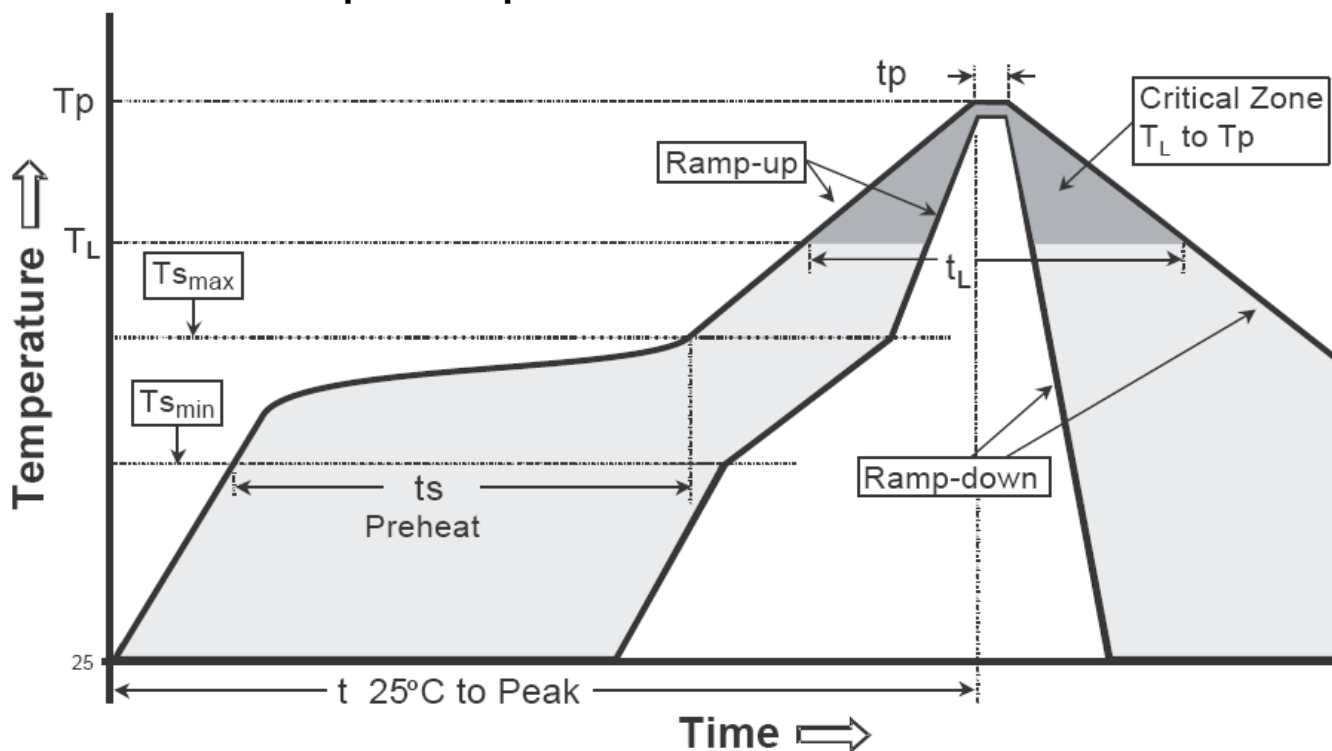

Profile feature	Sn-Pb eutectic Assembly	Pb-free Assembly
Average ramp-up rate (Tsmmax to Tp)	3°C/second max.	3°C/second max.
Preheat		
-Temperature Min(Ts min)	100°C	150°C
-Temperature Max(Ts max)	150°C	200°C
-Time(ts min to ts max)	60-120 seconds	60-180 seconds
Time maintained above:		
-Temperature (Tl)	183°C	217°C
- Time (tL)	60-150 seconds	60-150 seconds
Peak Temperature(Tp)	240 +0/-5 °C	260 +0/-5 °C
Time within 5°C of actual peak temperature(tp)	10-30 seconds	20-40 seconds
Ramp down rate	6°C/second max.	6°C/second max.
Time 25 °C to peak temperature	6 minutes max.	8 minutes max.

Note : All temperatures refer to topside of the package, measured on the package body surface.

SOT-523 Dimension

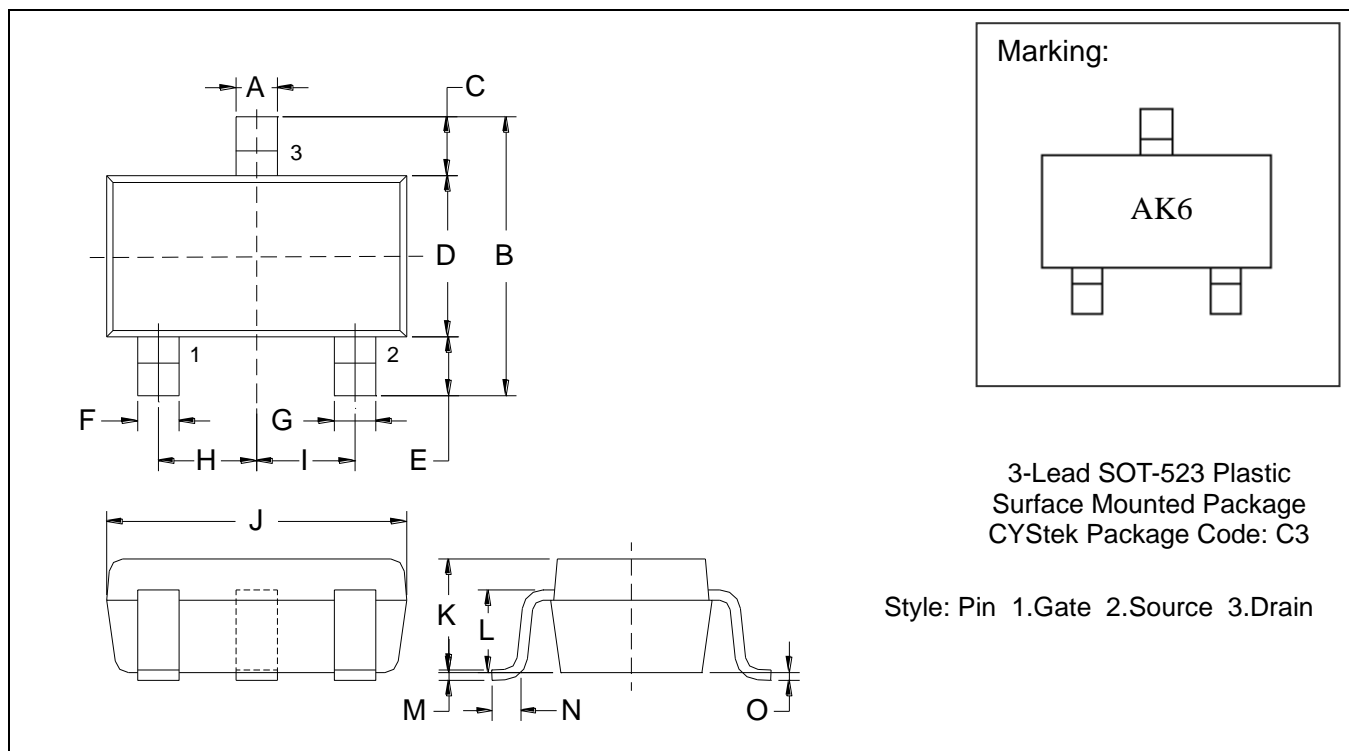

Marking:

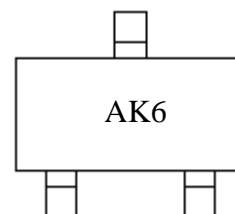

3-Lead SOT-523 Plastic
 Surface Mounted Package
 CYStek Package Code: C3

Style: Pin 1.Gate 2.Source 3.Drain

*: Typical

DIM	Inches		Millimeters		DIM	Inches		Millimeters	
	Min.	Max.	Min.	Max.		Min.	Max.	Min.	Max.
A	0.0079	0.0157	0.20	0.40	I	*0.0197	-	*0.50	-
B	0.0591	0.0669	1.50	1.70	J	0.0610	0.0650	1.55	1.65
C	0.0118	0.0197	0.30	0.50	K	0.0276	0.0315	0.70	0.80
D	0.0295	0.0335	0.75	0.85	L	0.0224	0.0248	0.57	0.63
E	0.0118	0.0197	0.30	0.50	M	0.0020	0.0059	0.05	0.15
F	0.0039	0.0118	0.10	0.30	N	0.0039	0.0118	0.10	0.30
G	0.0039	0.0118	0.10	0.30	O	0	0.0031	0	0.08
H	*0.0197	-	*0.50	-					

Notes: 1.Controlling dimension: millimeters.
 2.Maximum lead thickness includes lead finish thickness, and minimum lead thickness is the minimum thickness of base material.
 3.If there is any question with packing specification or packing method, please contact your local CYStek sales office.

Material:

- Lead: Pure tin plated.
- Mold Compound: Epoxy resin family, flammability solid burning class: UL94V-0

Important Notice:

- All rights are reserved. Reproduction in whole or in part is prohibited without the prior written approval of CYStek.
- CYStek reserves the right to make changes to its products without notice.
- CYStek **semiconductor products are not warranted to be suitable for use in Life-Support Applications, or systems.**
- CYStek assumes no liability for any consequence of customer product design, infringement of patents, or application assistance.