

**N-Channel Enhancement Mode Power MOSFET**

# MTA5D0N04V8

BV <sub>DSS</sub>		40V
I <sub>D</sub> @ T <sub>C</sub> =25°C, V <sub>GS</sub> =4.5V		47.6A
I <sub>D</sub> @ T <sub>A</sub> =25°C, V <sub>GS</sub> =4.5V		12.6A
R <sub>DSON(TYP)</sub>	V <sub>GS</sub> =4.5V, I <sub>D</sub> =12A	4.7mΩ
	V <sub>GS</sub> =2.5V, I <sub>D</sub> =8A	6.1mΩ

**Features**

- Single Drive Requirement
- Low On-resistance
- Fast Switching Characteristic
- Pb-free lead plating and halogen-free package

**Equivalent Circuit**

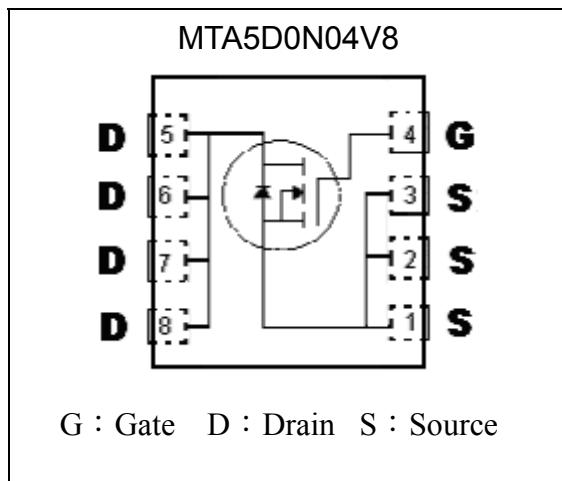

**Outline**

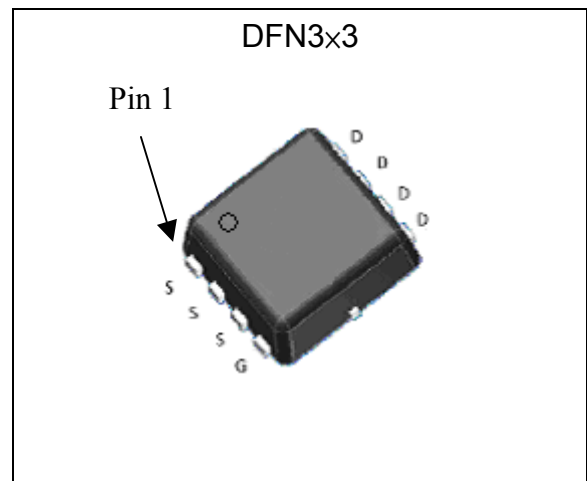

**Ordering Information**

Device	Package	Shipping
MTA5D0N04V8-0-T6-G	DFN3x3 (Pb-free lead plating and halogen-free package)	3000 pcs / Tape & Reel

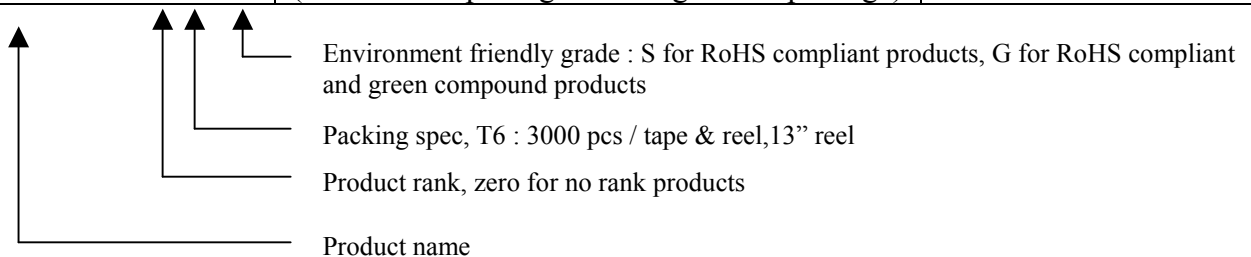



**Absolute Maximum Ratings** (Ta=25°C, unless otherwise specified)

Parameter	Symbol	Limits	Unit	
Drain-Source Voltage	V <sub>DS</sub>	40	V	
Gate-Source Voltage	V <sub>GS</sub>	±12		
Continuous Drain Current @ V <sub>GS</sub> =4.5V, T <sub>C</sub> =25°C	I <sub>D</sub>	47.6	A	
Continuous Drain Current @ V <sub>GS</sub> =4.5V, T <sub>C</sub> =100°C		30.1		
Continuous Drain Current @ V <sub>GS</sub> =4.5V, T <sub>A</sub> =25°C	I <sub>DSM</sub>	12.6		
Continuous Drain Current @ V <sub>GS</sub> =4.5V, T <sub>A</sub> =70°C		10.0		
Pulsed Drain Current	I <sub>DM</sub>	190 *1		
Avalanche Current @ L=0.1mH	I <sub>AS</sub>	45		
Avalanche Energy @ L=1mH, I <sub>D</sub> =20A, V <sub>DD</sub> =30V	E <sub>AS</sub>	200	mJ	
Total Power Dissipation	P <sub>D</sub>	T <sub>C</sub> =25°C	36	W
		T <sub>C</sub> =100°C	14	
	P <sub>DSM</sub>	T <sub>A</sub> =25°C	2.5 *2	
		T <sub>A</sub> =70°C	1.6 *2	
Operating Junction and Storage Temperature Range	T <sub>j</sub> , T <sub>stg</sub>	-55~+150	°C	

**Thermal Data**

Parameter	Symbol	Value	Unit
Thermal Resistance, Junction-to-case, max	R <sub>θJC</sub>	3.5	°C/W
Thermal Resistance, Junction-to-ambient, max	R <sub>θJA</sub>	50 *2	

- Note : 1. Pulse width limited by maximum junction temperature.  
 2. Surface mounted on a 1 in<sup>2</sup> pad of 2oz copper, t≤10s. In practice R<sub>θJA</sub> will be determined by customer's PCB characteristics. 125°C/W when mounted on a minimum pad of 2 oz. copper.  
 3. 100% tested by conditions of L=0.1mH, I<sub>AS</sub>=12A, V<sub>GS</sub>=10V, V<sub>DD</sub>=15V

**Characteristics (Tc=25°C, unless otherwise specified)**

Symbol	Min.	Typ.	Max.	Unit	Test Conditions
<b>Static</b>					
BV <sub>DSS</sub>	40	-	-	V	V <sub>GS</sub> =0V, I <sub>D</sub> =250μA
V <sub>GS(th)</sub>	0.3	-	1.2		V <sub>DS</sub> = V <sub>GS</sub> , I <sub>D</sub> =250μA
G <sub>FS</sub> *1	-	21.3	-	S	V <sub>DS</sub> =10V, I <sub>D</sub> =5A
I <sub>GSS</sub>	-	-	±100	nA	V <sub>GS</sub> =±12V
I <sub>DSS</sub>	-	-	1	μA	V <sub>DS</sub> =32V, V <sub>GS</sub> =0V
	-	-	5		V <sub>DS</sub> =32V, V <sub>GS</sub> =0V, T <sub>j</sub> =55°C
R <sub>DS(ON)</sub> *1	-	4.7	6.5	mΩ	V <sub>GS</sub> =4.5V, I <sub>D</sub> =12A
	-	6.1	9.5		V <sub>GS</sub> =2.5V, I <sub>D</sub> =8A
<b>Dynamic</b>					
C <sub>iss</sub>	-	2838	-	pF	V <sub>DS</sub> =25V, V <sub>GS</sub> =0V, f=1MHz
C <sub>oss</sub>	-	168	-		
C <sub>rss</sub>	-	123	-		
Q <sub>g</sub> *1, 2	-	78.6	-	nC	V <sub>DS</sub> =20V, V <sub>GS</sub> =10V, I <sub>D</sub> =12A
Q <sub>gs</sub> *1, 2	-	4.8	-		
Q <sub>gd</sub> *1, 2	-	11	-		

**Characteristics (Tc=25°C, unless otherwise specified)**

Symbol	Min.	Typ.	Max.	Unit	Test Conditions
t <sub>d(ON)</sub> *1, 2	-	12.2	-	ns	V <sub>DS</sub> =15V, I <sub>D</sub> =12A, V <sub>GS</sub> =10V, R <sub>GS</sub> =1 Ω
t <sub>r</sub> *1, 2	-	17.2	-		
t <sub>d(OFF)</sub> *1, 2	-	84.4	-		
t <sub>f</sub> *1, 2	-	6.2	-		
R <sub>g</sub>	-	1.2	-	Ω	f=1MHz
<b>Source-Drain Diode</b>					
I <sub>S</sub> *1	-	-	6	A	
V <sub>SD</sub> *1	-	0.78	1.2	V	I <sub>S</sub> =6A, V <sub>GS</sub> =0V
t <sub>rr</sub>	-	15.1	-	ns	I <sub>F</sub> =6A, dI <sub>F</sub> /dt=100A/μs
Q <sub>rr</sub>	-	9.8	-	nC	

Note : \*1.Pulse Test : Pulse Width ≤300μs, Duty Cycle≤2%  
 \*2.Independent of operating temperature

**Recommended Soldering Footprint**

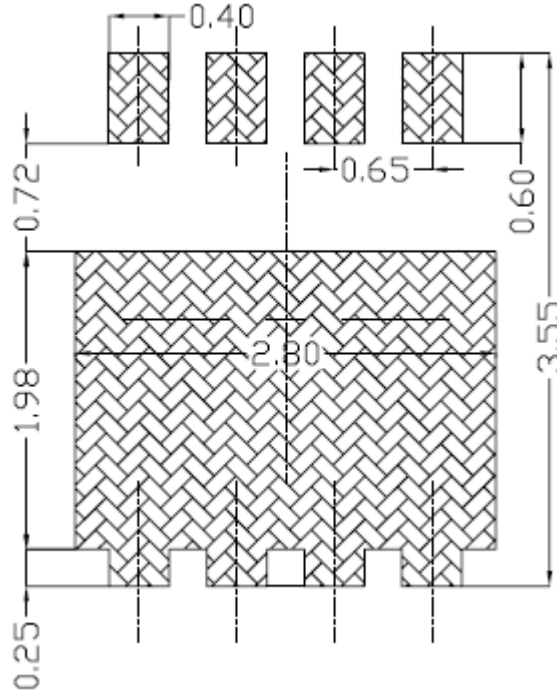

unit : mm

## Typical Characteristics

Typical Output Characteristics

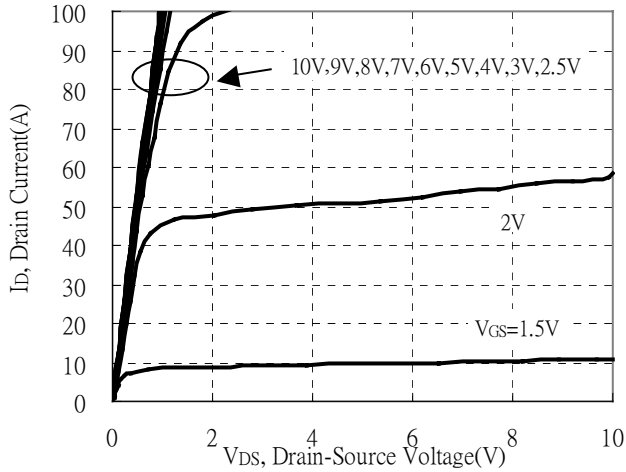

Brekdown Voltage vs Ambient Temperature

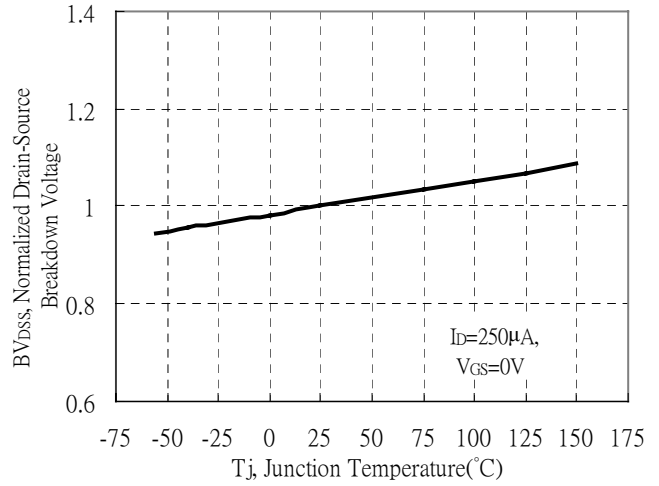

Static Drain-Source On-State resistance vs Drain Current

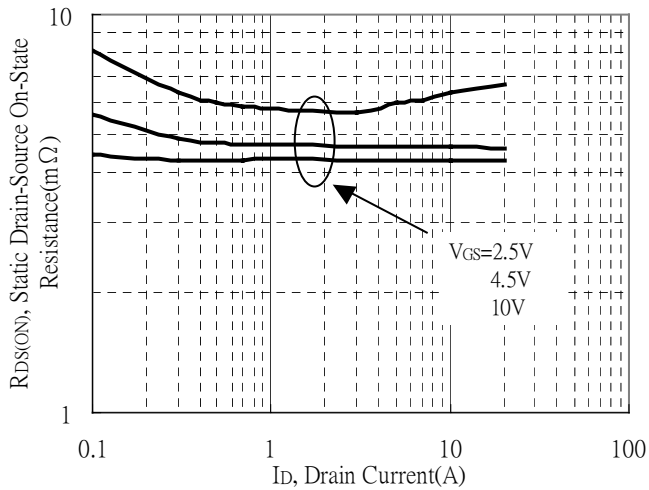

Reverse Drain Current vs Source-Drain Voltage

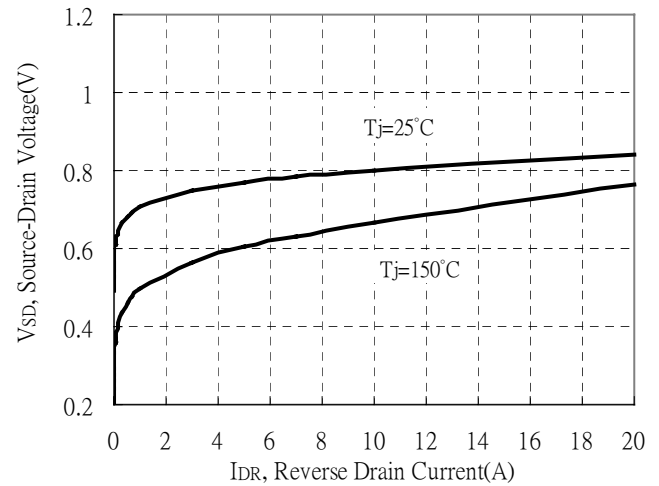

Static Drain-Source On-State Resistance vs Gate-Source Voltage

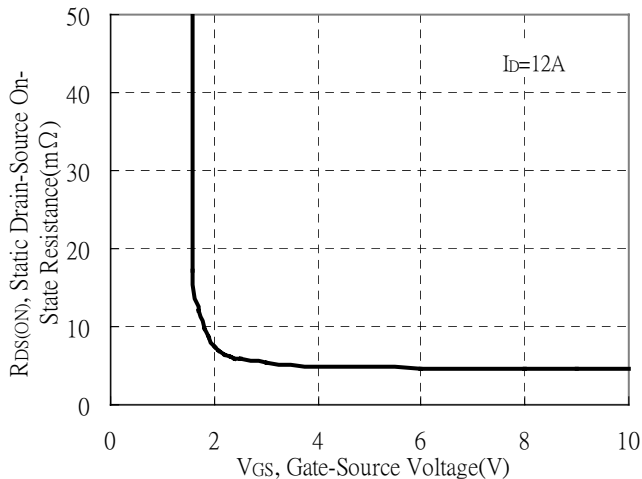

Drain-Source On-State Resistance vs Junction Temperature

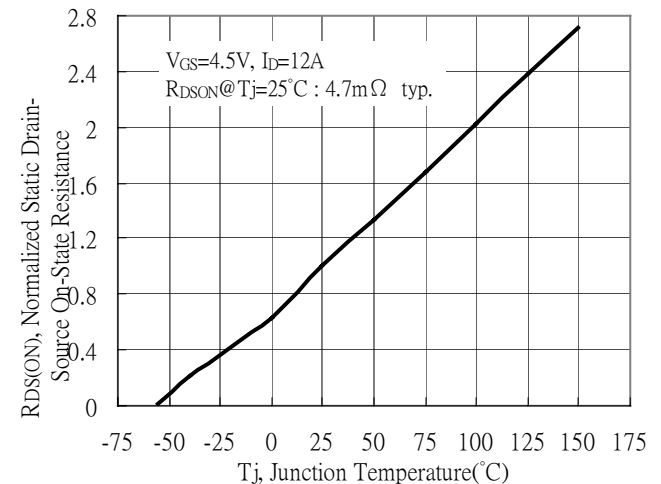

**Typical Characteristics(Cont.)**

Capacitance vs Drain-to-Source Voltage

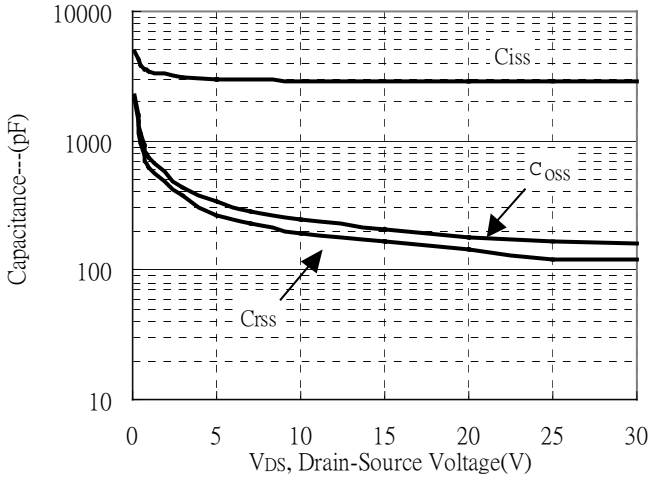

Threshold Voltage vs Junction Temperature

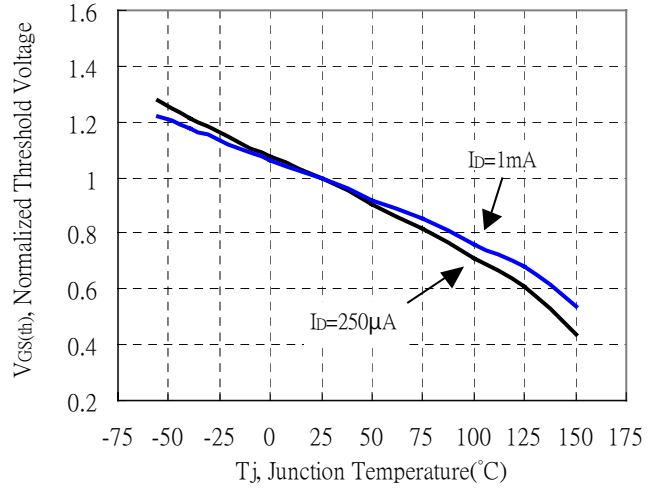

Forward Transfer Admittance vs Drain Current

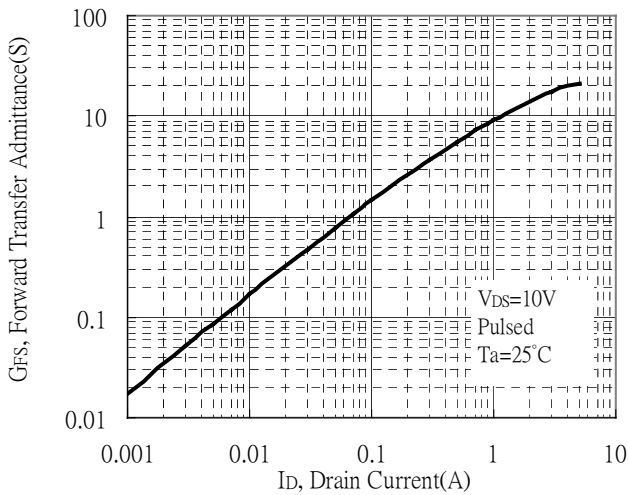

Gate Charge Characteristics

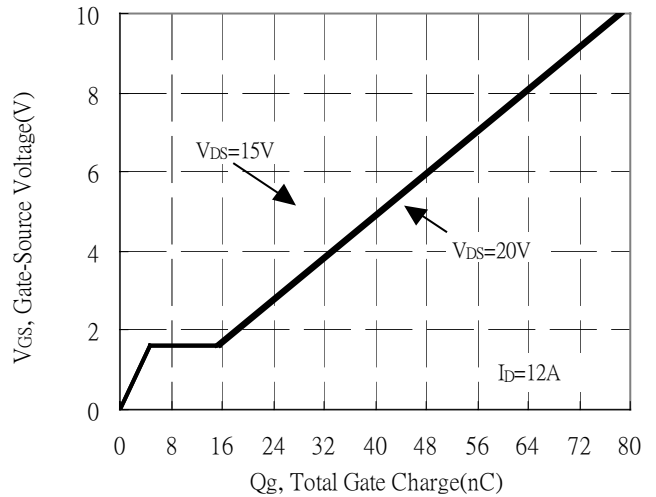

Maximum Safe Operating Area

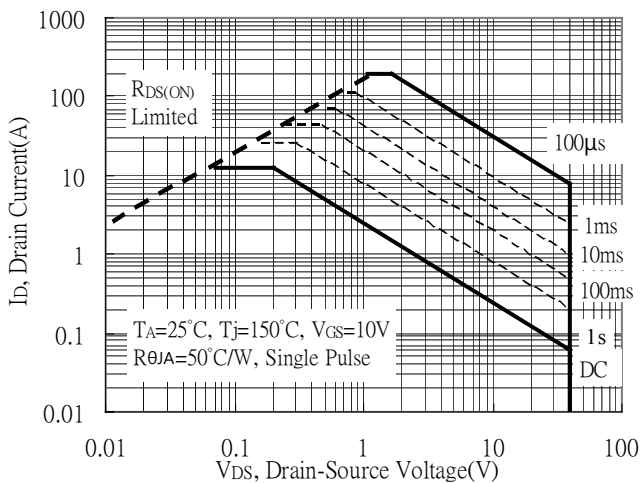

Maximum Drain Current vs Junction Temperature

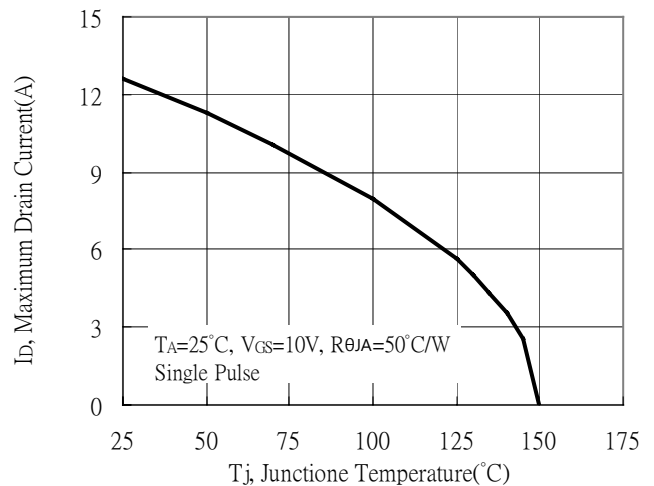



**Typical Characteristics(Cont.)**

Typical Transfer Characteristics

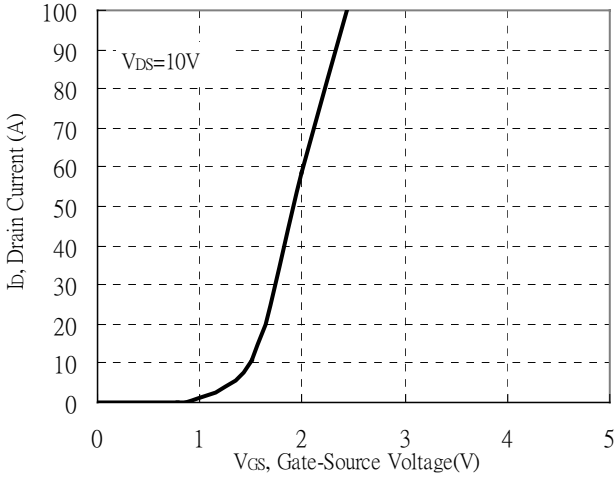

Single Pulse Power Rating, Junction to Ambient  
 (Note on page 2)

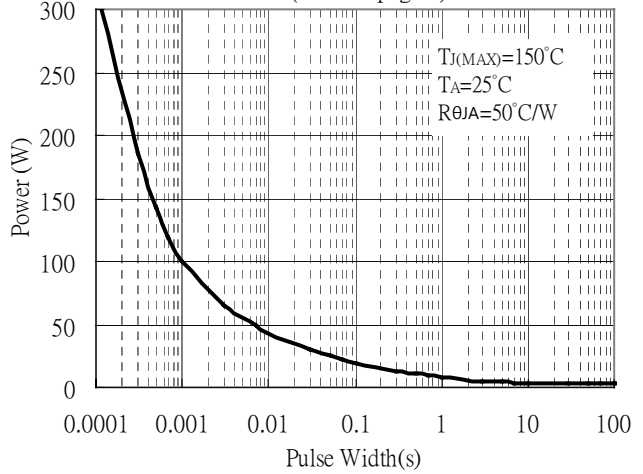

Transient Thermal Response Curves

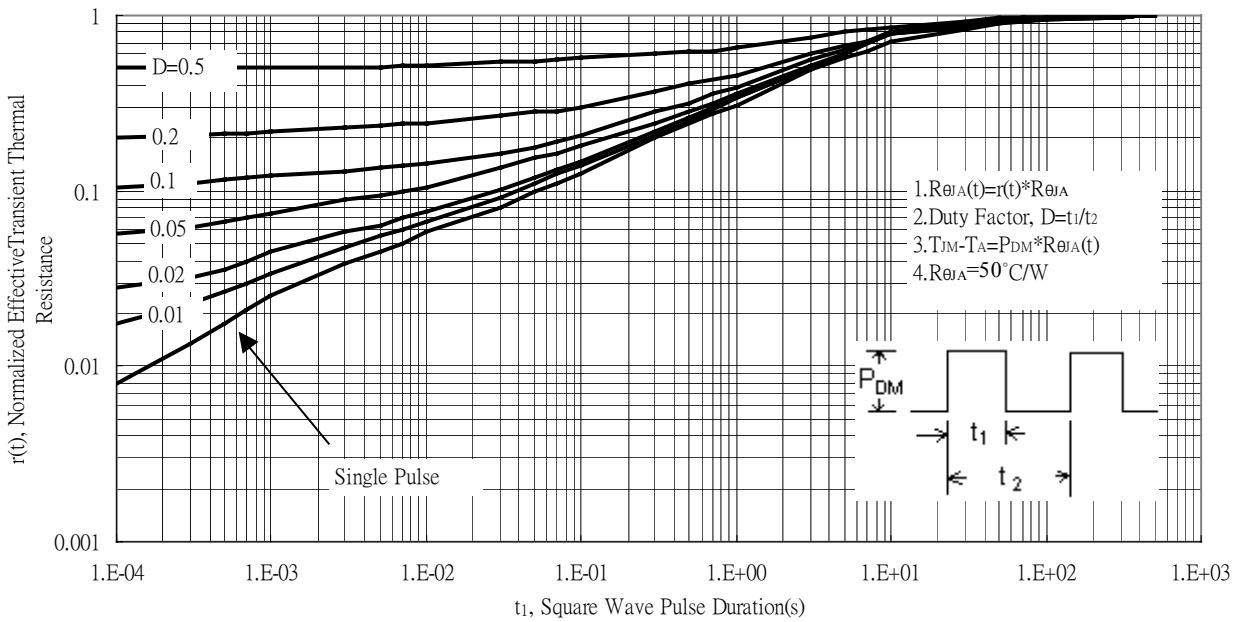

**Reel Dimension**

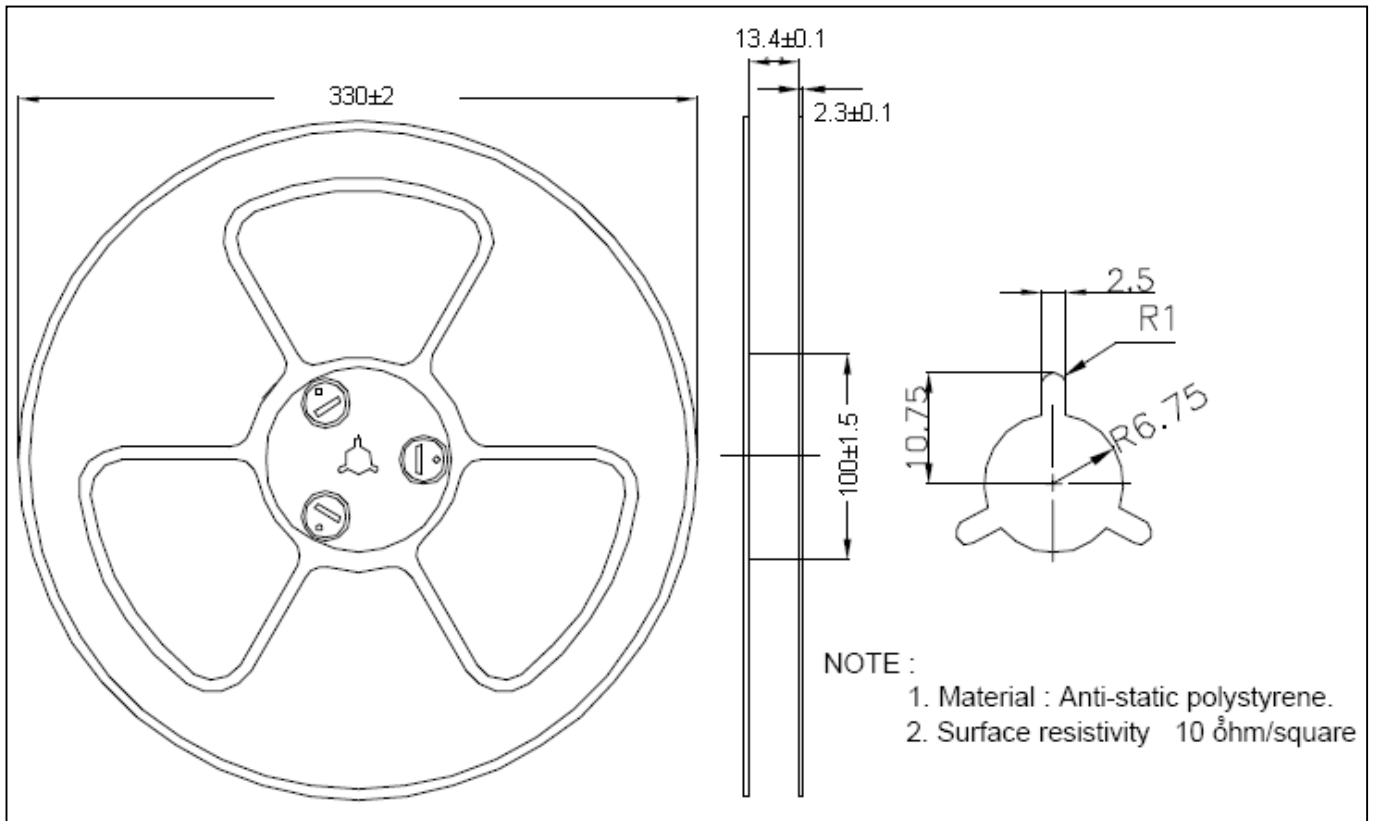

**Carrier Tape Dimension**

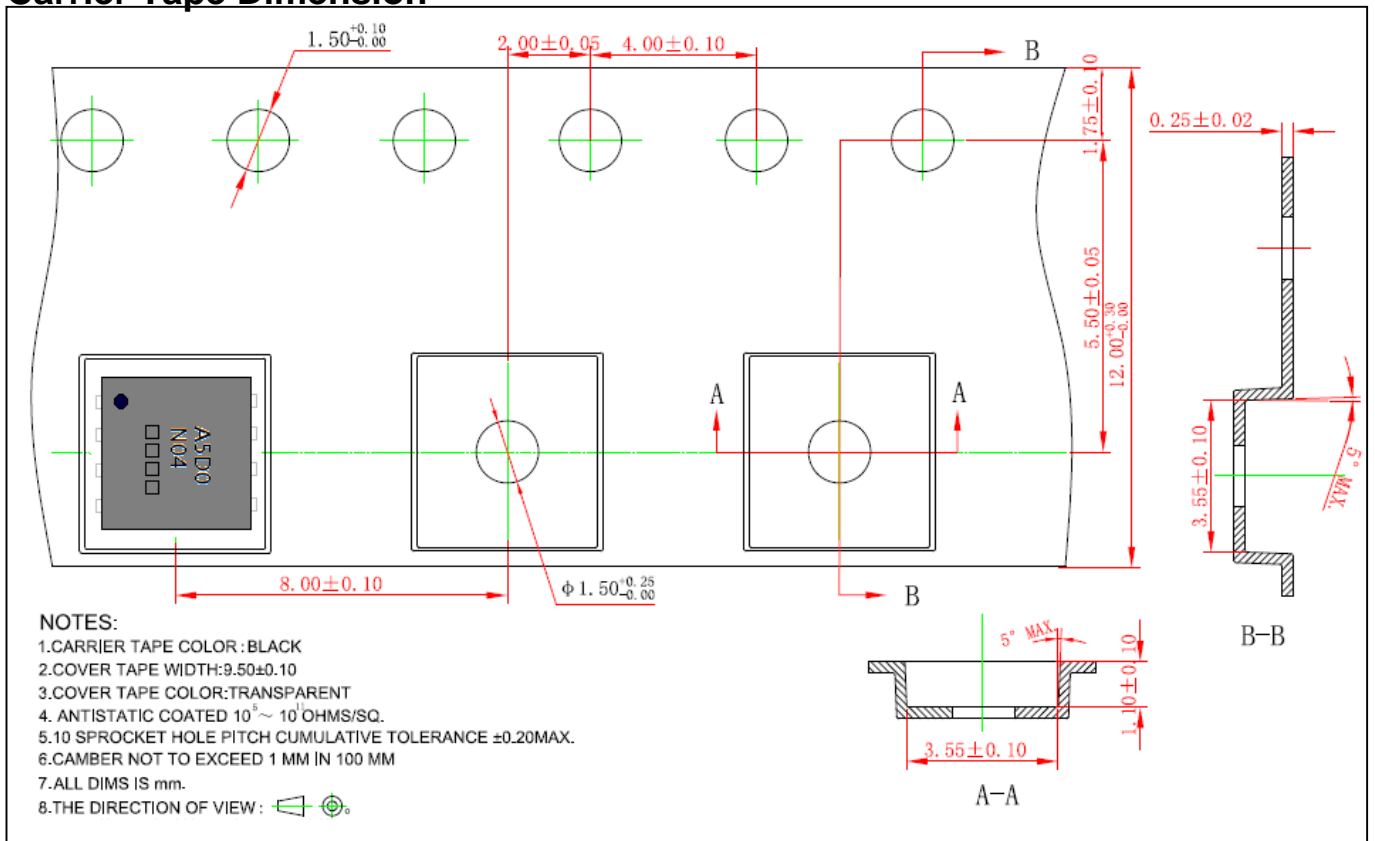

**Recommended wave soldering condition**

Product	Peak Temperature	Soldering Time
Pb-free devices	260 +0/-5 °C	5 +1/-1 seconds

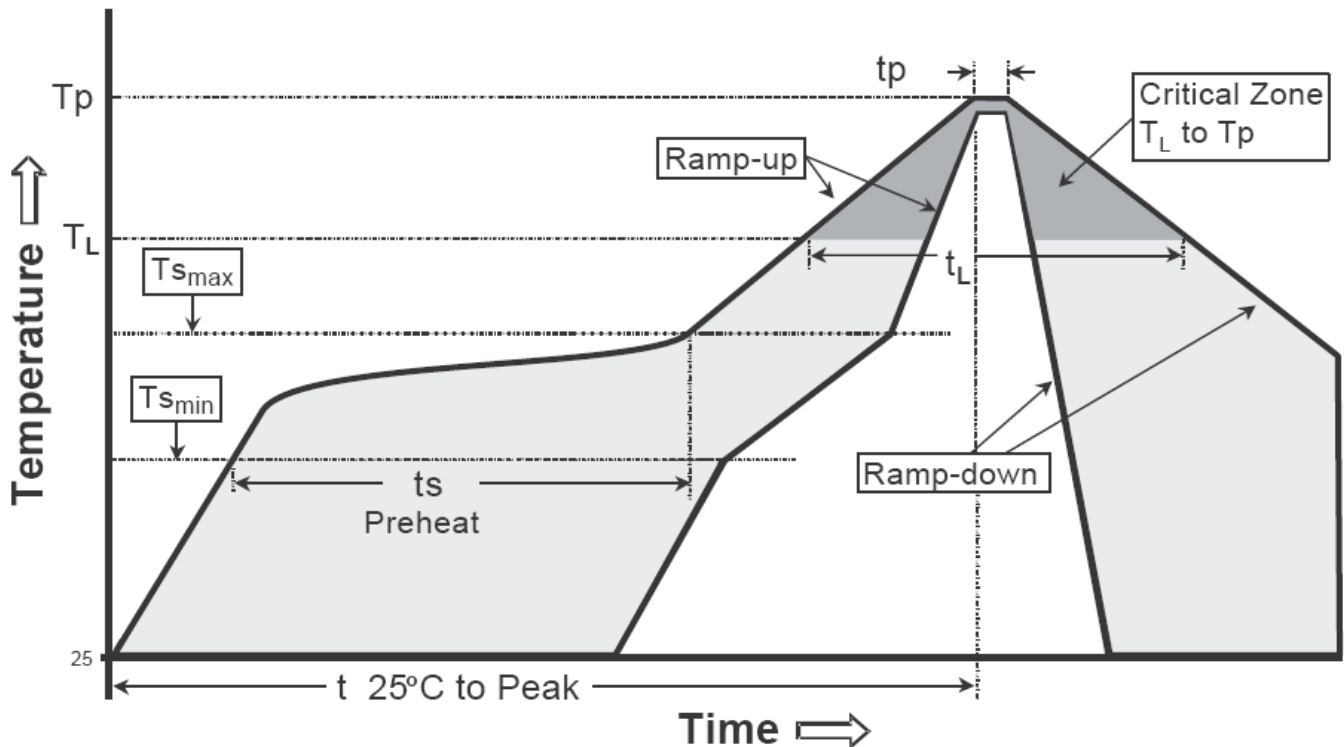
**Recommended temperature profile for IR reflow**

Profile feature	Sn-Pb eutectic Assembly	Pb-free Assembly
Average ramp-up rate (T <sub>smax</sub> to T <sub>p</sub> )	3°C/second max.	3°C/second max.
Preheat		
-Temperature Min(T <sub>s min</sub> )	100°C	150°C
-Temperature Max(T <sub>s max</sub> )	150°C	200°C
-Time(t <sub>s min</sub> to t <sub>s max</sub> )	60-120 seconds	60-180 seconds
Time maintained above:		
-Temperature (T <sub>L</sub> )	183°C	217°C
- Time (t <sub>L</sub> )	60-150 seconds	60-150 seconds
Peak Temperature(T <sub>P</sub> )	240 +0/-5 °C	260 +0/-5 °C
Time within 5°C of actual peak temperature(tp)	10-30 seconds	20-40 seconds
Ramp down rate	6°C/second max.	6°C/second max.
Time 25 °C to peak temperature	6 minutes max.	8 minutes max.

Note :1. All temperatures refer to topside of the package, measured on the package body surface.  
 2. For devices mounted on FR-4 PCB of 1.6mm or equivalent grade PCB. If other grade PCB is used, care should be taken to match the coefficients of thermal expansion between components and PCB. If they are not matched well, the solder joints may crack or the bodies of the parts may crack or shatter as the assembly cools.



**DFN3x3 Dimension**

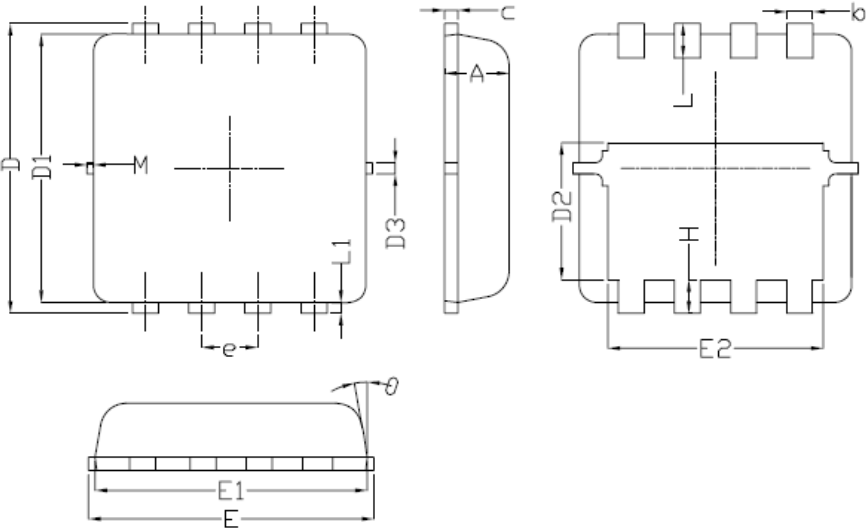

**Marking:**

D D D D

**A5D0**

**N04**

□□□□

S S S G

**8-Lead DFN3x3 Plastic Package**  
CYStek Package Code: V8

DIM	Millimeters		Inches		DIM	Millimeters		Inches	
	Min.	Max.	Min.	Max.		Min.	Max.	Min.	Max.
A	0.70	0.80	0.028	0.031	E1	3.00	3.20	0.118	0.126
b	0.25	0.35	0.010	0.014	E2	2.39	2.59	0.094	0.102
c	0.10	0.25	0.004	0.010	e	0.65 BSC		0.026 BSC	
D	3.25	3.45	0.128	0.136	H	0.30	0.50	0.012	0.020
D1	3.00	3.20	0.118	0.126	L	0.30	0.50	0.012	0.020
D2	1.48	1.68	0.058	0.066	L1	0.13 TYP		0.005 TYP	
D3	0.13 TYP		0.005 TYP		θ	8°	12°	8°	12°
E	3.20	3.40	0.126	0.134	M	-	0.15	-	0.006

**Notes:** 1. Controlling dimension: millimeters.  
 2. Maximum lead thickness includes lead finish thickness, and minimum lead thickness is the minimum thickness of base material.  
 3. If there is any question with packing specification or packing method, please contact your local CYStek sales office.

**Material:**

- Lead: pure tin plated.
- Mold Compound: Epoxy resin family, flammability solid burning class: UL94V-0.

**Important Notice:**

- All rights are reserved. Reproduction in whole or in part is prohibited without the prior written approval of CYStek.
- CYStek reserves the right to make changes to its products without notice.
- CYStek **semiconductor products are not warranted to be suitable for use in Life-Support Applications, or systems.**
- CYStek assumes no liability for any consequence of customer product design, infringement of patents, or application assistance.