

P-CHANNEL ENHANCEMENT MODE POWER MOSFET

MTA040P03Q8

Features

- Simple drive requirement
- Low on-resistance
- Fast switching speed
- Pb-free lead plating and halogen-free package

BV_{DSS}	-30V
$I_D @ T_A=25^{\circ}C, V_{GS}=-10V$	-6A
$R_{DSON} @ V_{GS}=-10V, I_D=-6A$	43m Ω (typ)
$R_{DSON} @ V_{GS}=-4.5V, I_D=-4A$	49m Ω (typ)
$R_{DSON} @ V_{GS}=-2.5V, I_D=-2A$	60m Ω (typ)

Equivalent Circuit

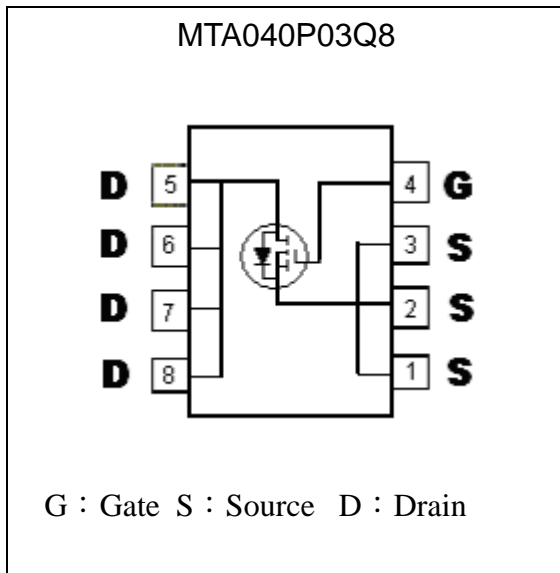

Outline

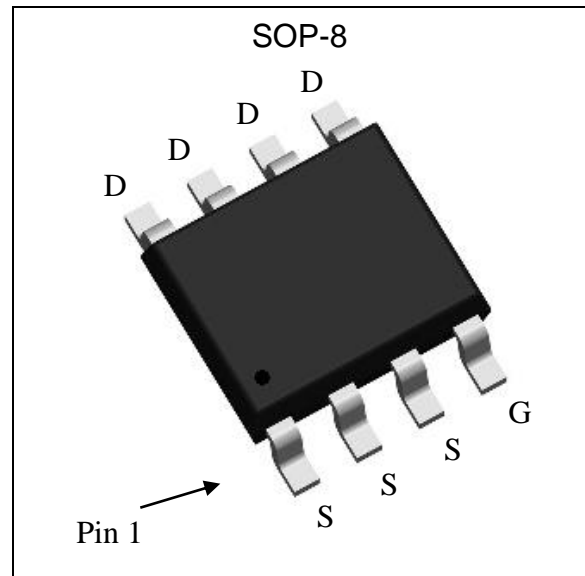

Ordering Information

Device	Package	Shipping
MTA040P03Q8-0-T3-G	SOP-8 (Pb-free lead plating and halogen-free package)	2500 pcs / tape & reel
MTA040P03Q8-0-TF-G	SOP-8 (Pb-free lead plating and halogen-free package)	4000 pcs / tape & reel

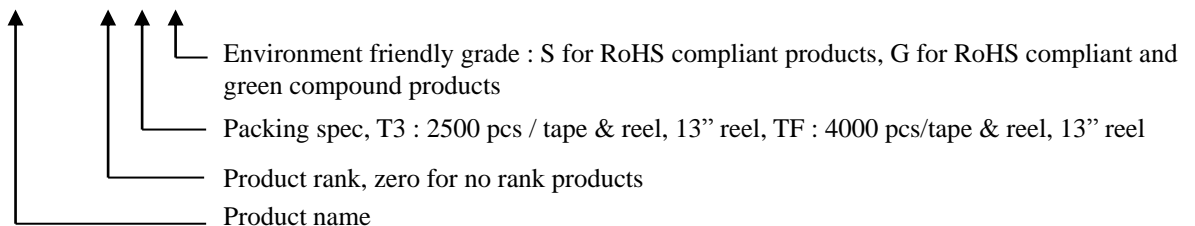



Absolute Maximum Ratings (Ta=25°C)

Parameter	Symbol	Limits	Unit
Drain-Source Breakdown Voltage	BV _{DSS}	-30	V
Gate-Source Voltage	V _{GS}	±12	
Continuous Drain Current (Note 1)	I _D	T _A =25°C, V _{GS} =-10V	-6
		T _A =70°C, V _{GS} =-10V	-4.8
Pulsed Drain Current (Note 2)	I _{DM}	-30	A
Single Pulse Avalanche Current @ L=0.1mH	I _{AS}	-18	
Single Pulse Avalanche Energy (Note 3)	E _{AS}	16	
Total Power Dissipation (Note 1)	P _D	T _A =25°C	3.1
		T _A =70°C	2
Operating Junction and Storage Temperature Range	T _j ; T _{stg}	-55~+150	°C

Note : 1.Surface mounted on FR-4 board, t≤10sec. The value in any given application depends on the user's specific board design.

2.Pulse width ≤300μs, Duty Cycle≤2%

3.L=0.1mH, I_{AS}=-18A, V_{GS}=-10V, V_{DD}=-15V

Thermal Data

Parameter	Symbol	Value	Unit
Thermal Resistance, Junction-to-case, max	R _{θJC}	25	°C/W
Thermal Resistance, Junction-to-ambient, max	R _{θJA}	40 (Note)	

Note : Surface mounted on 1 in²copper pad of FR-4 board, pulse width≤10s.

Electrical Characteristics (T_j=25°C, unless otherwise specified)

Symbol	Min.	Typ.	Max.	Unit	Test Conditions
Static					
BV _{DSS}	-30	-	-	V	V _{GS} =0V, I _D =-250μA
V _{GS(th)}	-0.5	-	-1.3		V _{DS} =V _{GS} , I _D =-250μA
I _{GSS}	-	-	±100	nA	V _{GS} =±12V, V _{DS} =0V
I _{DSS}	-	-	-1	μA	V _{DS} =-30V, V _{GS} =0V
	-	-	-5		V _{DS} =-24V, V _{GS} =0V, T _j =55°C
*R _{DS(ON)}	-	43	56	mΩ	V _{GS} =-10V, I _D =-6A
	-	49	65		V _{GS} =-4.5V, I _D =-4A
	-	60	80		V _{GS} =-2.5V, I _D =-2A
*G _{FS}	-	7.9	-	S	V _{DS} =-10V, I _D =-3A
Dynamic					
C _{iss}	-	1067	-	pF	V _{DS} =-15V, V _{GS} =0V, f=1MHz
C _{oss}	-	69	-		
C _{rss}	-	62	-		

* $t_{d(ON)}$	-	4.8	-	ns	$V_{DD}=-15V, I_D=-6A, V_{GS}=-10V, R_G=6\Omega$
* t_r	-	14	-		
* $t_{d(OFF)}$	-	111.8	-		
* t_f	-	58.6	-		
* Q_g	-	11.4	-	nC	$V_{DS}=-15V, V_{GS}=-4.5V, I_D=-6A$
* Q_{gs}	-	8.6	-		
* Q_{gd}	-	2	-		
R_g	-	2.7	-	Ω	$f=1MHz$
Source Drain Diode					
* I_S	-	-	-3	A	
* I_{SM}	-	-	-12		
* V_{SD}	-	-0.77	-1	V	$V_{GS}=0V, I_S=-1A$
* t_{rr}	-	7.9	-	ns	$I_F=-6A, dI_F/dt=100A/\mu s$
* Q_{rr}	-	4.1	-	nC	

*Pulse Test : Pulse Width $\leq 300\mu s$, Duty Cycle $\leq 2\%$

Recommended Soldering Footprint

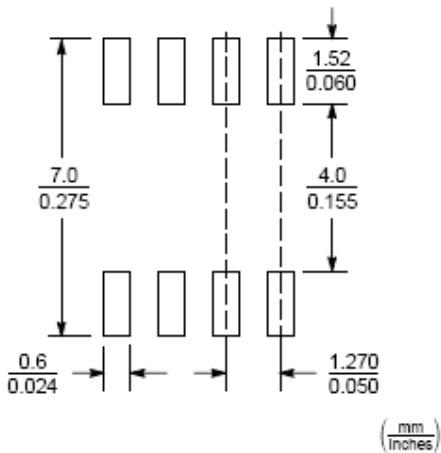

Typical Characteristics

Typical Output Characteristics

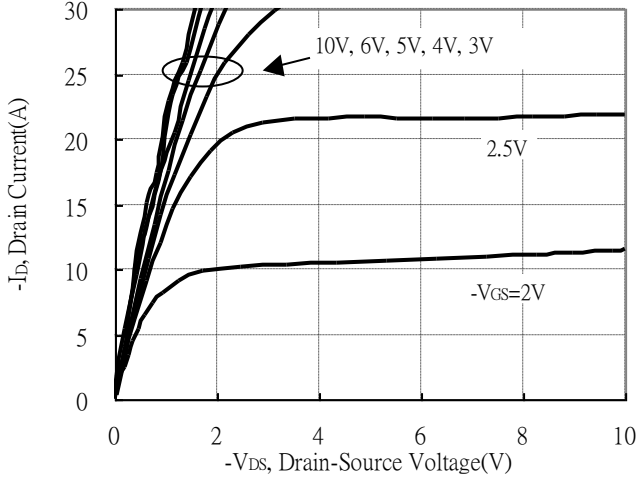

Breakdown Voltage vs Temperature

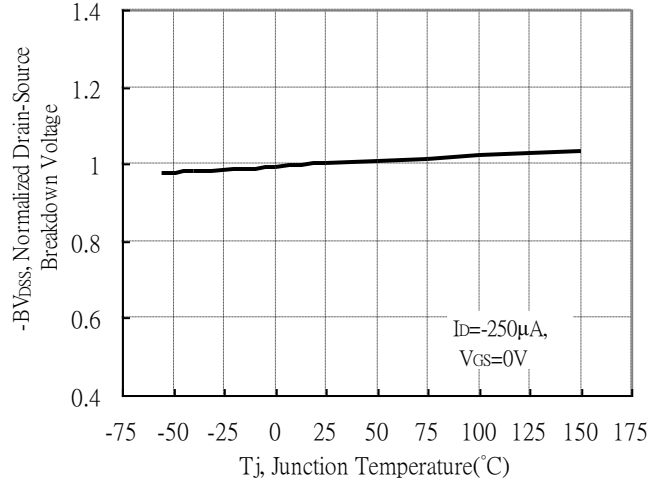

Static Drain-Source On-State resistance vs Drain Current

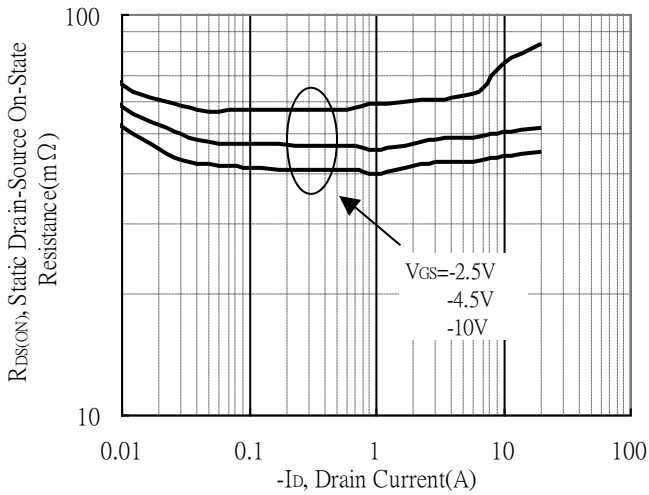

Reverse Drain Current vs Source-Drain Voltage

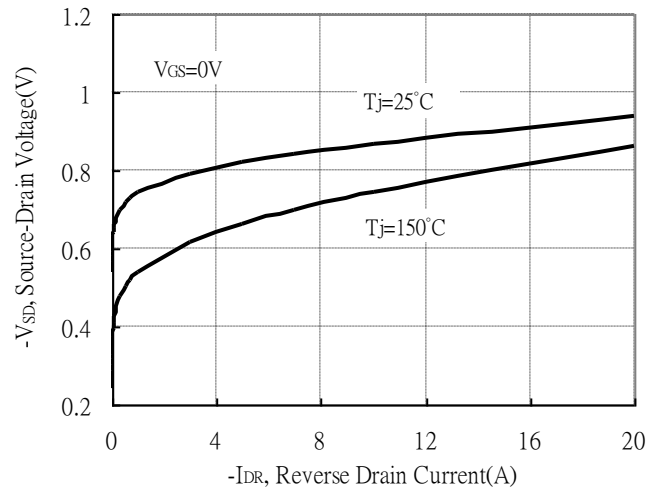

Static Drain-Source On-State Resistance vs Gate-Source Voltage

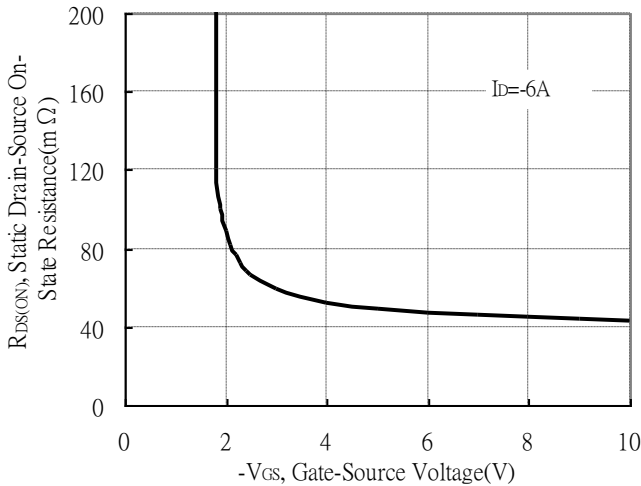

Drain-Source On-State Resistance vs Junction Temperature

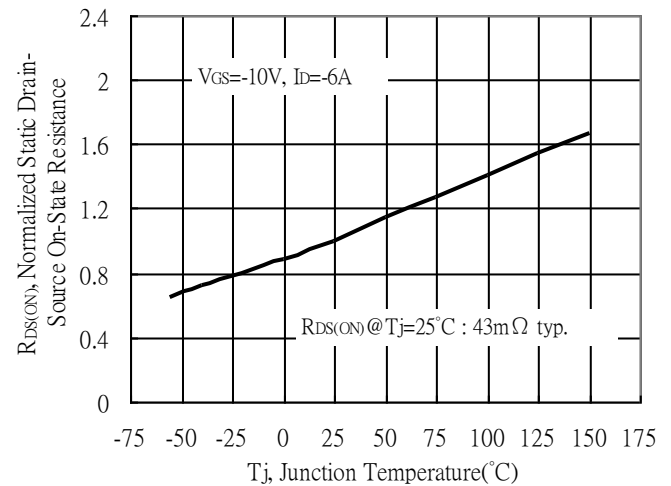

Typical Characteristics(Cont.)

Capacitance vs Drain-to-Source Voltage

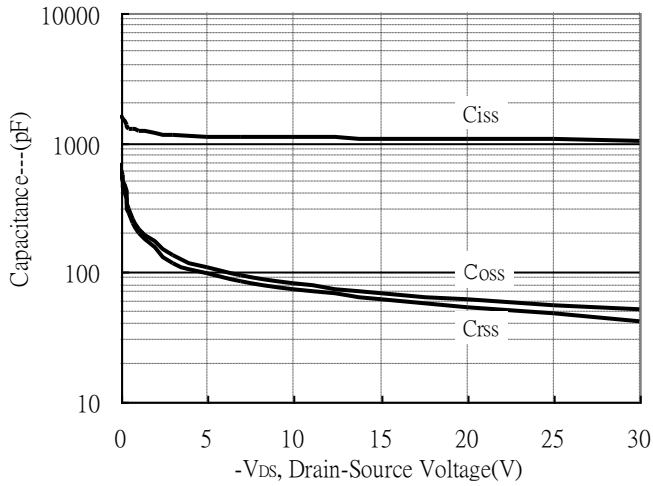

Threshold Voltage vs Junction Temperature

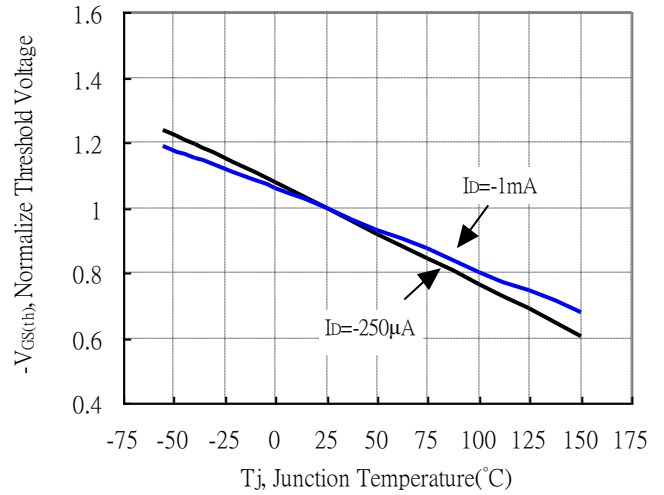

Maximum Safe Operating Area

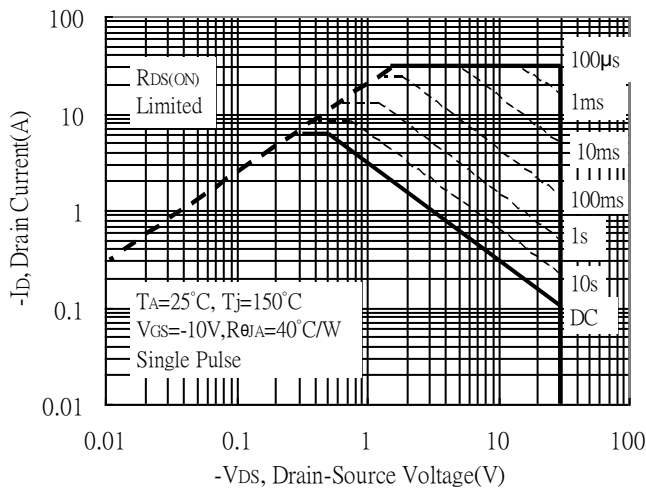

Gate Charge Characteristics

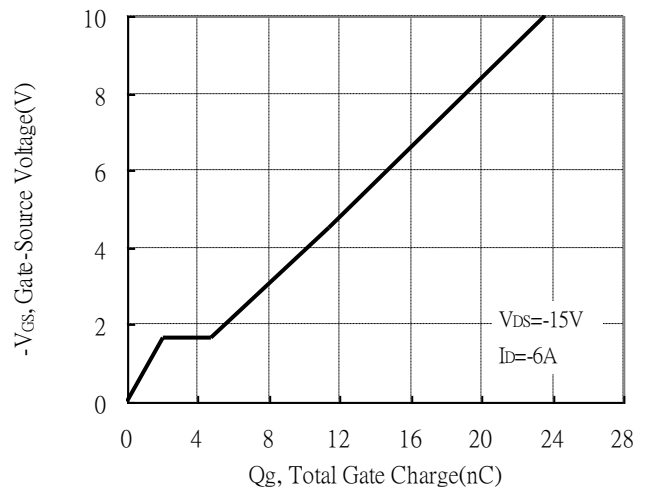

Maximum Drain Current vs Junction Temperature

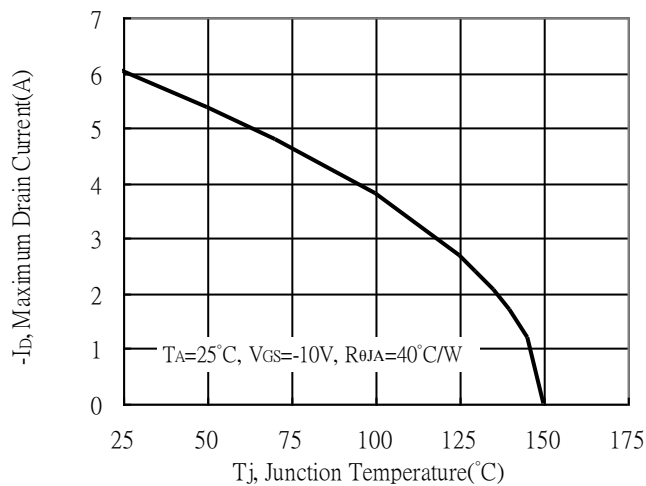

Forward Transfer Admittance vs Drain Current

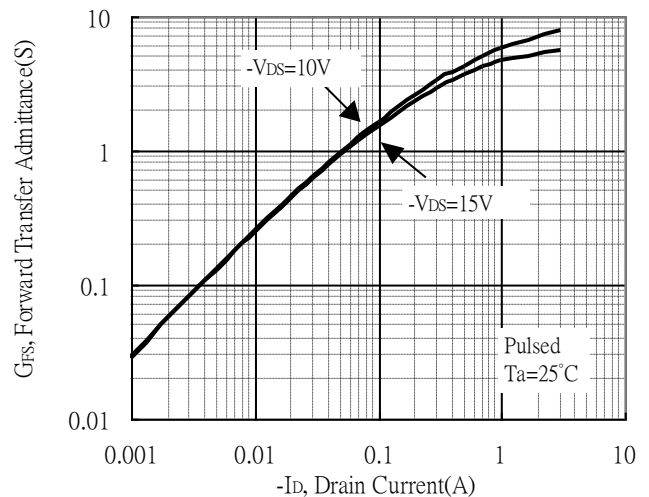



Typical Characteristics(Cont.)

Typical Transfer Characteristics

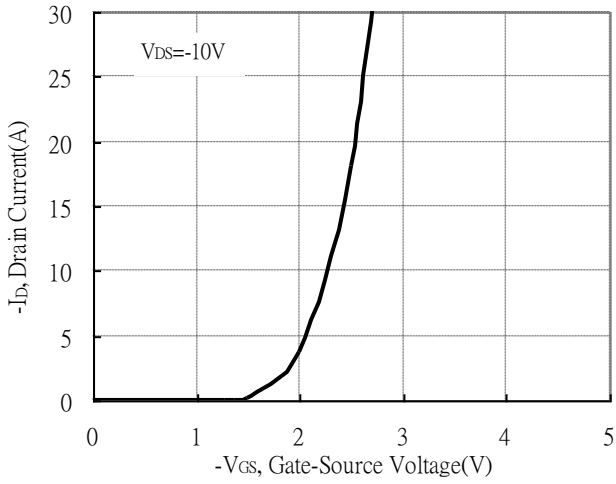

Single Pulse Power Rating, Junction to Ambient
(Note on page 2)

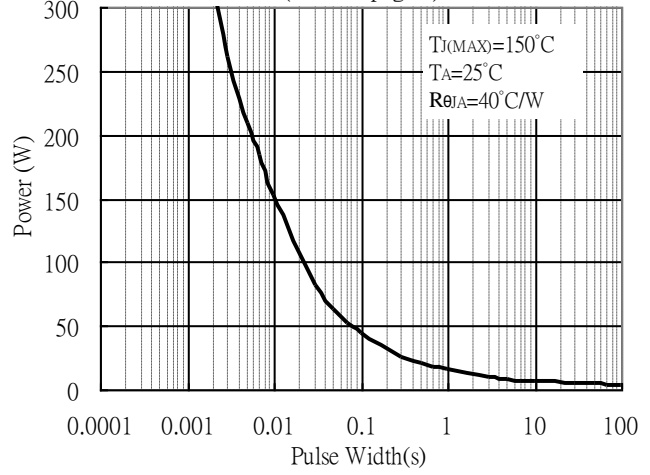

Transient Thermal Response Curves

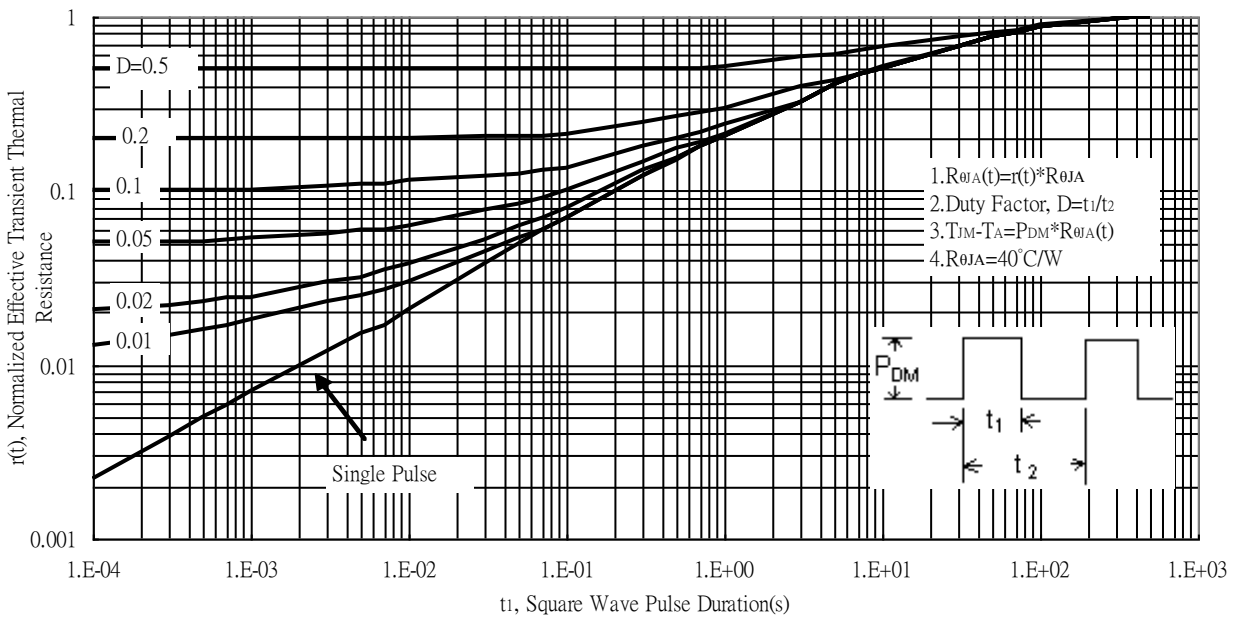

Reel Dimension

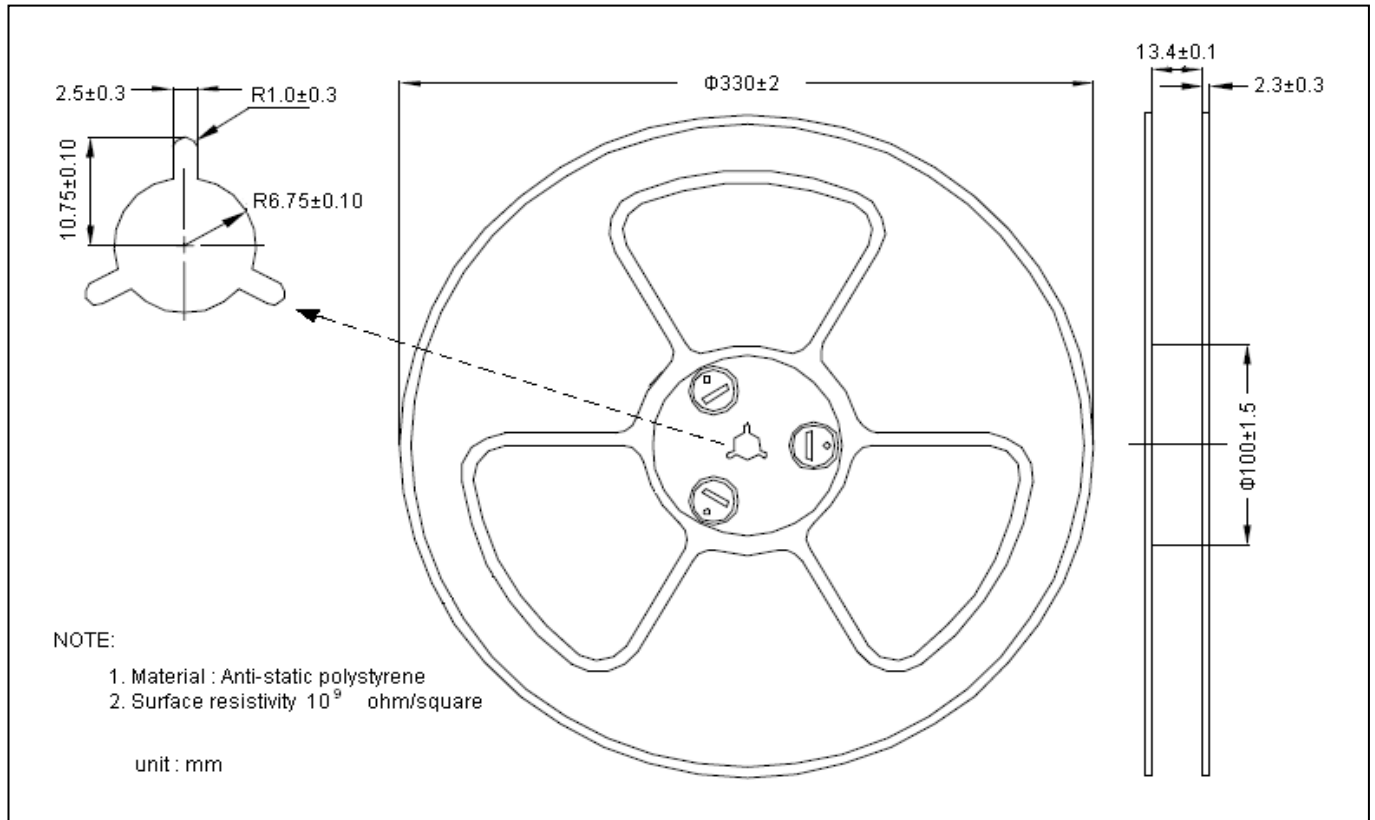

Carrier Tape Dimension

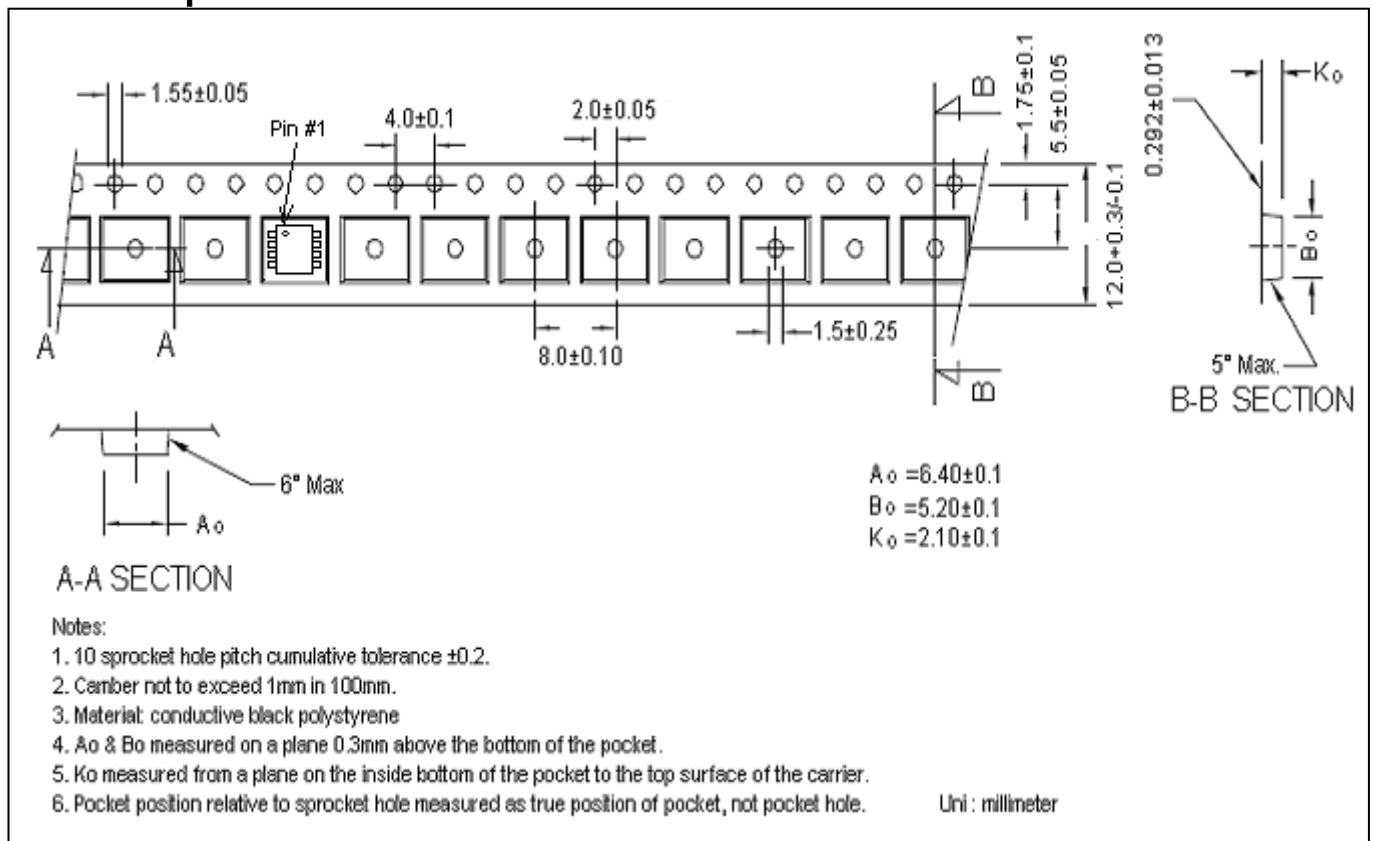

Recommended wave soldering condition

Product	Peak Temperature	Soldering Time
Pb-free devices	260 +0/-5 °C	5 +1/-1 seconds

Recommended temperature profile for IR reflow

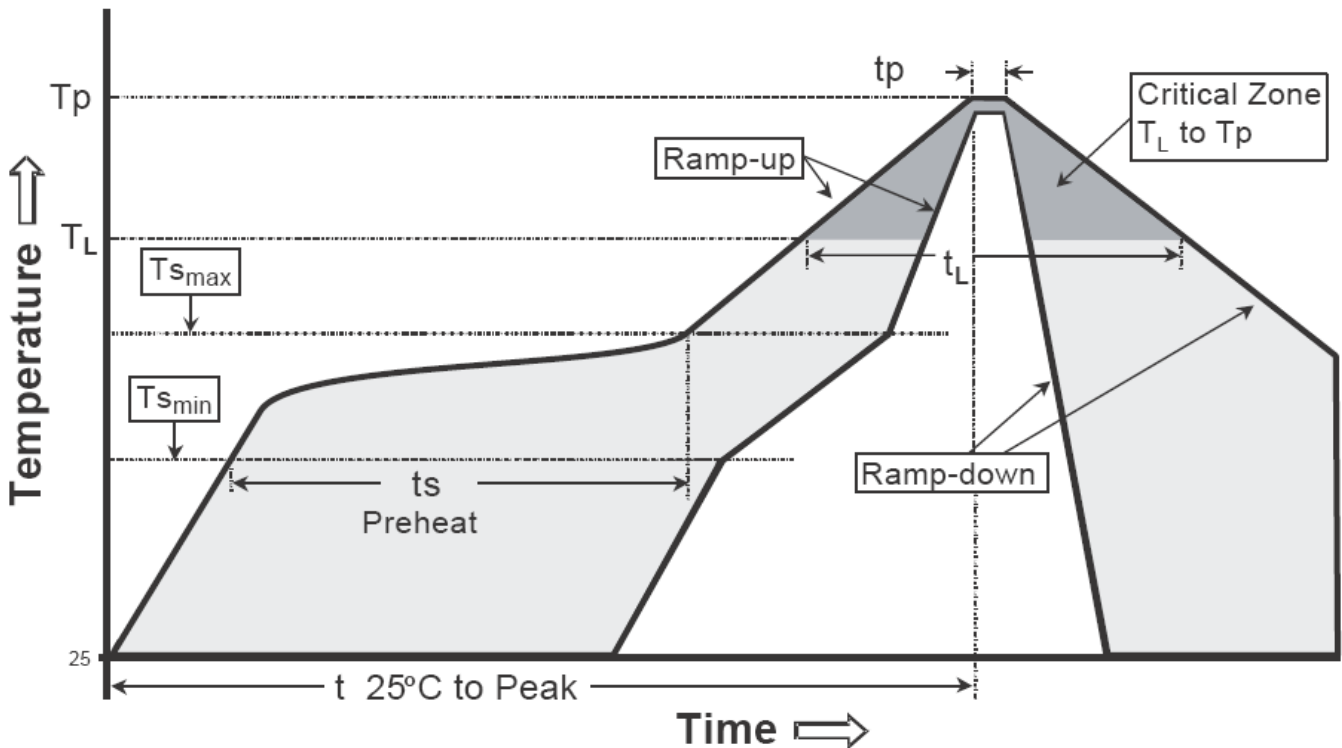

Profile feature	Sn-Pb eutectic Assembly	Pb-free Assembly
Average ramp-up rate (Tsmax to Tp)	3°C/second max.	3°C/second max.
Preheat		
-Temperature Min(Ts min)	100°C	150°C
-Temperature Max(Ts max)	150°C	200°C
-Time(ts min to ts max)	60-120 seconds	60-180 seconds
Time maintained above:		
-Temperature (TL)	183°C	217°C
- Time (tL)	60-150 seconds	60-150 seconds
Peak Temperature(Tp)	240 +0/-5 °C	260 +0/-5 °C
Time within 5°C of actual peak temperature(tp)	10-30 seconds	20-40 seconds
Ramp down rate	6°C/second max.	6°C/second max.
Time 25 °C to peak temperature	6 minutes max.	8 minutes max.

Note : All temperatures refer to topside of the package, measured on the package body surface.

SOP-8 Dimension

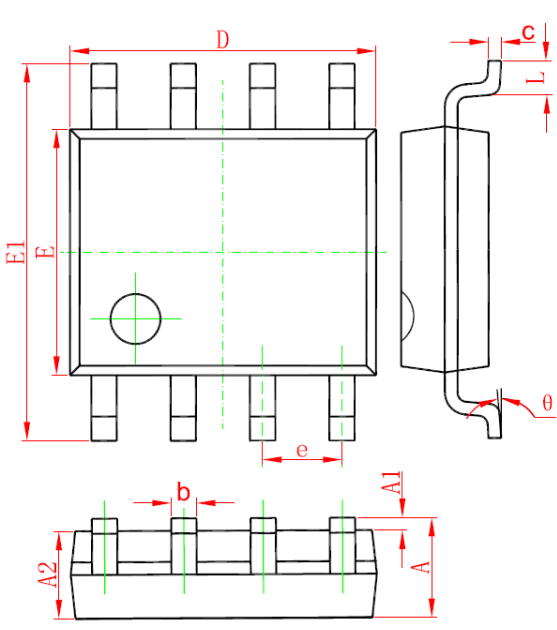

The diagram shows three views of an 8-lead SOP-8 package: a top view with dimensions D, E, E1, and e; a side view with dimensions L, c, and θ ; and a bottom view with dimensions A, A1, A2, and b.

Marking:

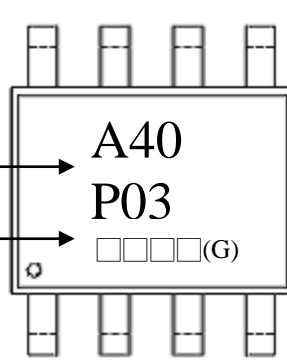

The marking diagram shows a top view of the package with 'A40' and 'P03' printed in the center. Below them are four square characters for the date code, with a circled 'G' to the right. Arrows point from 'Device Name' to 'A40' and 'Date Code' to the square characters.

Date Code(counting from left to right) :

1st code: year code, the last digit of Christian year
 2nd code : month code, Jan→A, Feb→B, Mar→C, Apr→D
 May→E, Jun→F, Jul→G, Aug→H, Sep→J,
 Oct→K, Nov→L, Dec→M
 3rd and 4th codes : production serial number, 01~99

8-Lead SOP-8 Plastic Package
 CYStek Package Code: Q8

*: Typical

DIM	Millimeters		Inches		DIM	Millimeters		Inches	
	Min.	Max.	Min.	Max.		Min.	Max.	Min.	Max.
A	1.350	1.750	0.053	0.069	E	3.800	4.000	0.150	0.157
A1	0.100	0.250	0.004	0.010	E1	5.800	6.200	0.228	0.244
A2	1.350	1.550	0.053	0.061	e	*1.270		*0.050	
b	0.330	0.510	0.013	0.020	L	0.400	1.270	0.016	0.050
c	0.170	0.250	0.006	0.010	θ	0°	8°	0°	8°
D	4.700	5.100	0.185	0.200					

Notes: 1.Controlling dimension: millimeters.
 2.Maximum lead thickness includes lead finish thickness, and minimum lead thickness is the minimum thickness of base material.
 3.If there is any question with packing specification or packing method, please contact your local CYStek sales office.

Material:

- Lead: Pure tin plated.
- Mold Compound: Epoxy resin family, flammability solid burning class: UL94V-0.

Important Notice:

- All rights are reserved. Reproduction in whole or in part is prohibited without the prior written approval of CYStek.
- CYStek reserves the right to make changes to its products without notice.
- CYStek **semiconductor products are not warranted to be suitable for use in Life-Support Applications, or systems.**
- CYStek assumes no liability for any consequence of customer product design, infringement of patents, or application assistance.