

-14V P-Channel Enhancement Mode MOSFET

MTA025P01DFJ6

BV_{DSS}	-14V
$I_D@V_{GS}=-4.5V, T_C=25^\circ C$	-7.9A
$I_D@V_{GS}=-4.5V, T_A=25^\circ C$	-5.7A
$R_{DSON}@V_{GS}=-4.5V, I_D=-5.5A$	21.8mΩ (typ.)
$R_{DSON}@V_{GS}=-4V, I_D=-4A$	22.7mΩ (typ.)
$R_{DSON}@V_{GS}=-2.5V, I_D=-4A$	29.3mΩ (typ.)
$R_{DSON}@V_{GS}=-1.8V, I_D=-2.5A$	41.0mΩ (typ.)

Features

- Low on-resistance
- Excellent thermal and electrical capabilities
- Pb-free lead plating and halogen-free package

Equivalent Circuit

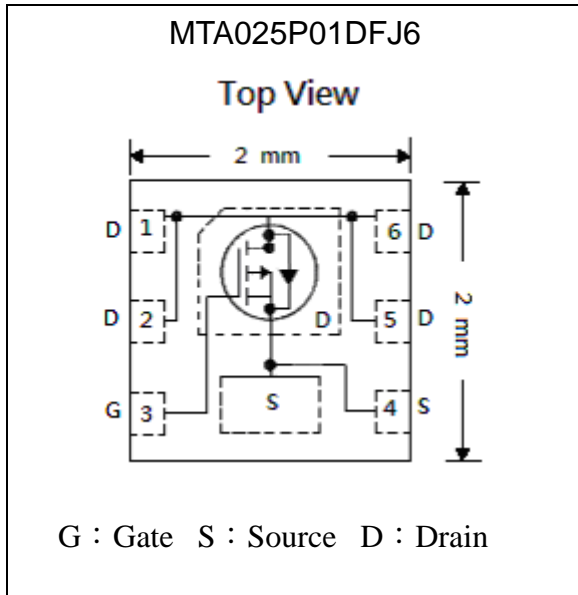

Outline

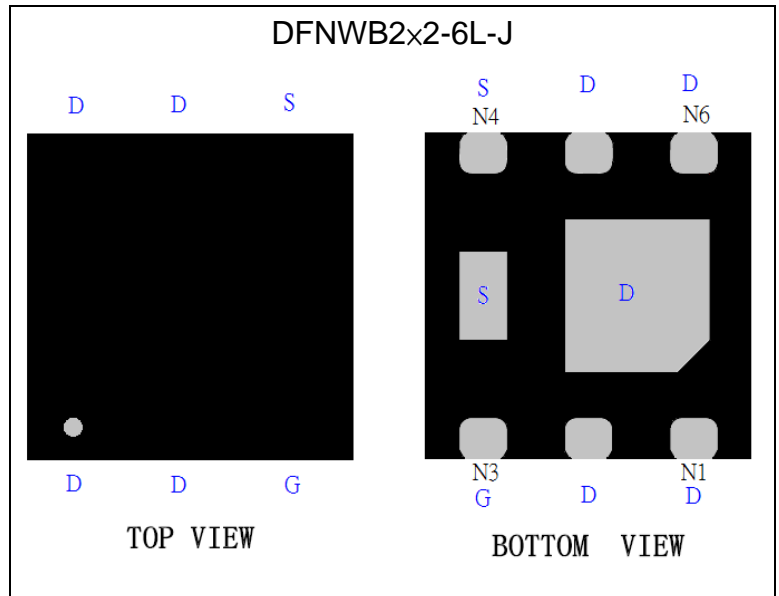

Ordering Information

Device	Package	Shipping
MTA025P01DFJ6-0-T1-G	DFNWB2x2-6L-J (Pb-free lead plating and halogen-free package)	3000 pcs / tape & reel

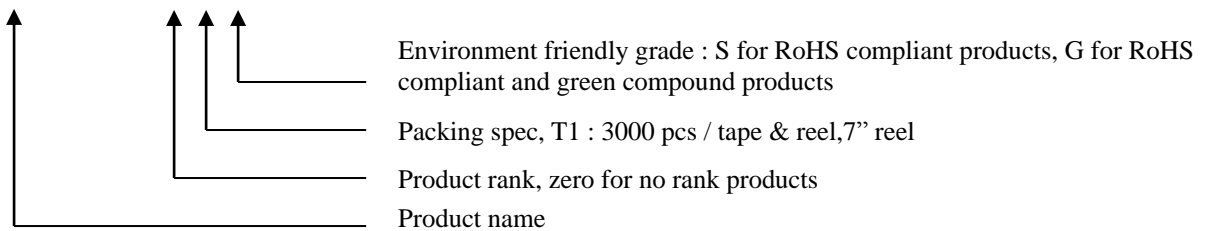



Absolute Maximum Ratings (Ta=25°C)

Parameter	Symbol	Limits	Unit
Drain-Source Voltage	V _{DS}	-14	V
Gate-Source Voltage	V _{GS}	±8	
Continuous Drain Current @ T _A =25°C, V _{GS} =-4.5V (Note 3)	I _{DSM}	-5.7	A
Continuous Drain Current @ T _A =70°C, V _{GS} =-4.5V (Note 3)		-4.7	
Continuous Drain Current @ T _C =25°C, V _{GS} =-4.5V	I _D	-7.9	
Continuous Drain Current @ T _C =70°C, V _{GS} =-4.5V		-6.3	
Pulsed Drain Current (Note 1, 2)	I _{DM}	-32	
Power Dissipation @ T _A =25°C (Note 3)	P _{DSM}	2.1	W
Power Dissipation @ T _A =70°C (Note 3)		1.3	
Power Dissipation @ T _C =25°C	P _D	3.9	
Power Dissipation @ T _C =70°C		2.5	
Operating Junction and Storage Temperature	T _j , T _{stg}	-55~+150	°C

Thermal Data

Parameter	Symbol	Value	Unit
Thermal Resistance, Junction-to-case, max	R _{th,j-c}	32	°C/W
Thermal Resistance, Junction-to-ambient, max	R _{th,j-a}	60 (Note 3)	

- Note : 1. Pulse width limited by maximum junction temperature
 2. Duty cycle ≤ 1%
 3. Surface mounted on 1 in² copper pad of FR-4 board.

Electrical Characteristics (Ta=25°C)

Symbol	Min.	Typ.	Max.	Unit	Test Conditions
Static					
BV _{DSS}	-14	-	-	V	V _{GS} =0V, I _D =-250μA
V _{GS(th)}	-0.4	-	-1.0		V _{DS} =V _{GS} , I _D =-250μA
I _{GSS}	-	-	±100	nA	V _{GS} =±8V, V _{DS} =0V
I _{DSS}	-	-	-1	μA	V _{DS} =-10V, V _{GS} =0V
	-	-	-10		V _{DS} =-10V, V _{GS} =0V, T _j =55°C
*R _{DS(ON)}	-	21.8	31	mΩ	V _{GS} =-4.5V, I _D =-5.5A
	-	22.7	32		V _{GS} =-4 V, I _D =-4A
	-	29.3	45		V _{GS} =-2.5V, I _D =-4A
	-	41.0	60		V _{GS} =-1.8V, I _D =-2.5A
*G _{FS}	-	8.3	-	S	V _{DS} =-10V, I _D =-3A
Dynamic					
C _{iss}	-	1229	-	pF	V _{DS} =-10V, V _{GS} =0V, f=1MHz
C _{oss}	-	225	-		
C _{rss}	-	205	-		

$t_{d(ON)}$	-	14	-	ns	$V_{DS}=-10V, I_D=-1A, V_{GS}=-4.5V, R_G=6\Omega$
t_r	-	26.2	-		
$t_{d(OFF)}$	-	110.4	-		
t_f	-	93	-		
Q_g	-	14.7	-	nC	$V_{DS}=-10V, I_D=-4A, V_{GS}=-4.5V$
Q_{gs}	-	1.9	-		
Q_{gd}	-	4.6	-		
R_g	-	20	-	Ω	$f=1MHz$
Source-Drain Diode					
$*V_{SD}$	-	-0.64	-1.0	V	$V_{GS}=0V, I_S=-1A$
$*t_{rr}$	-	67	-	ns	$I_F=-4A, dI_F/dt=100A/\mu s$
$*Q_{rr}$	-	39	-	nC	

*Pulse Test : Pulse Width $\leq 300\mu s$, Duty Cycle $\leq 2\%$

Recommended Soldering Footprint

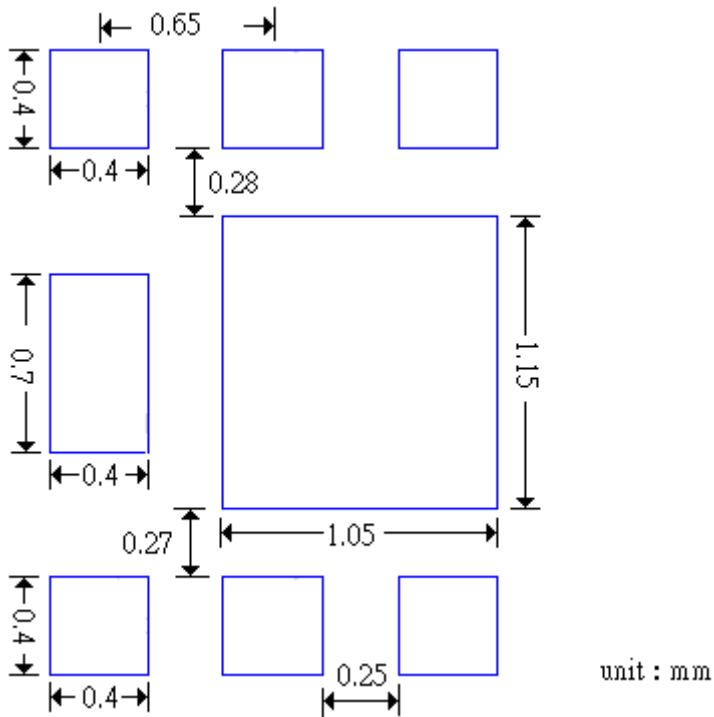

Typical Characteristics

Typical Output Characteristics

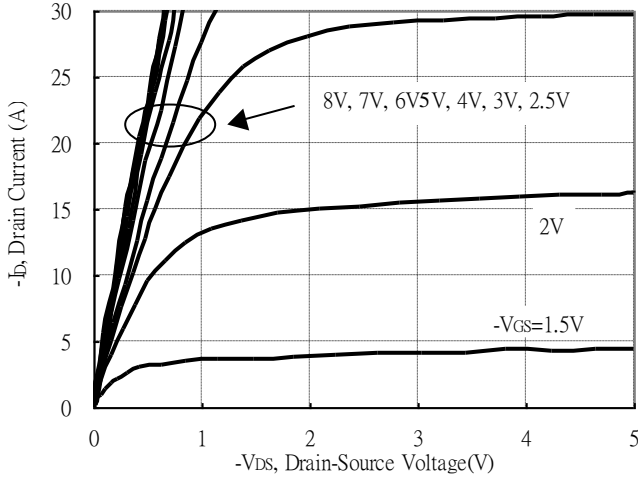

Breakdown Voltage vs Ambient Temperature

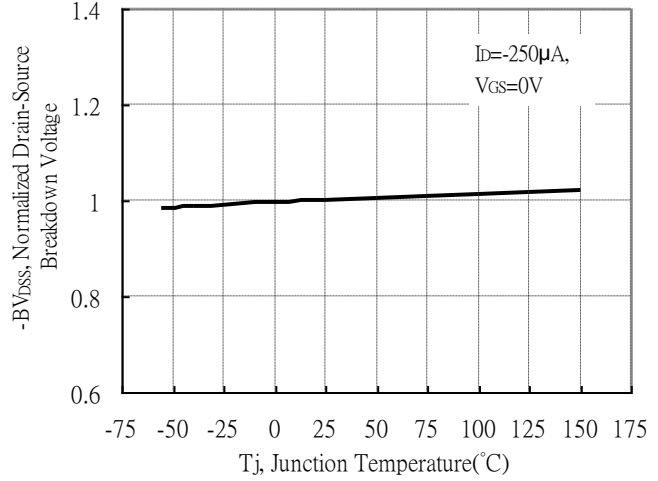

Static Drain-Source On-State resistance vs Drain Current

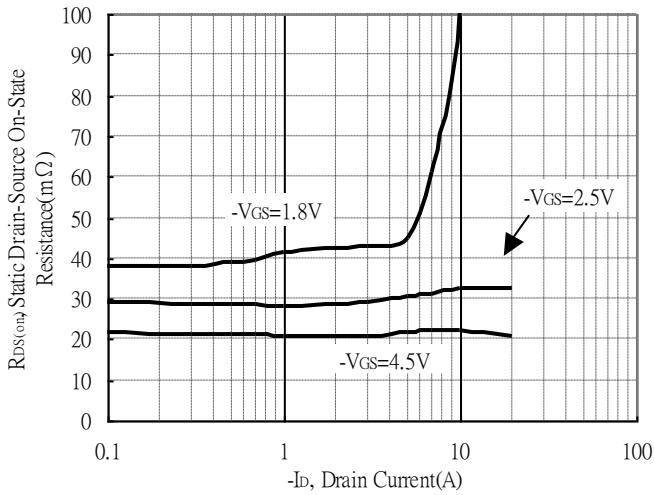

Reverse Drain Current vs Source-Drain Voltage

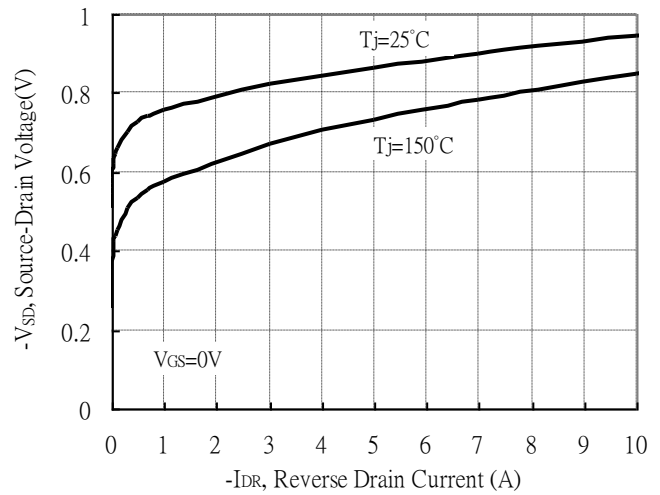

Static Drain-Source On-State Resistance vs Gate-Source Voltage

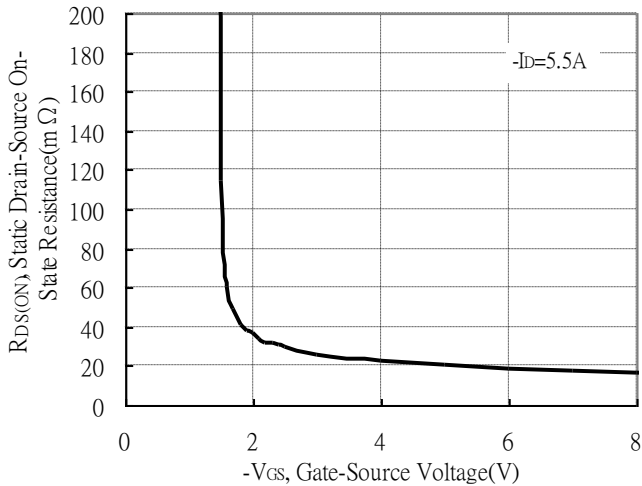

Drain-Source On-State Resistance vs Junction Temperature

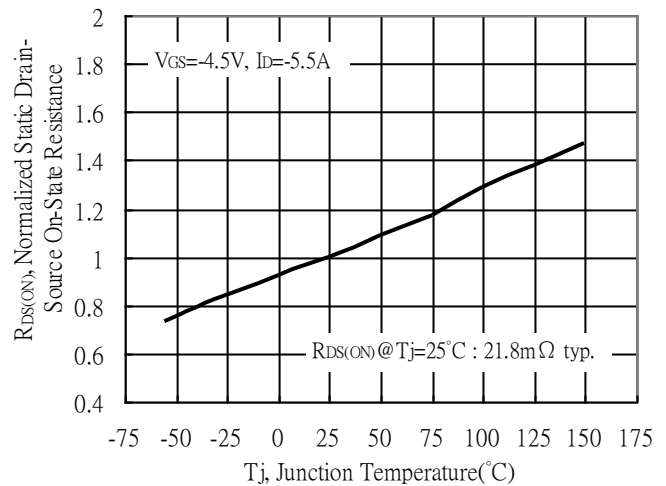



Typical Characteristics(Cont.)

Capacitance vs Drain-to-Source Voltage

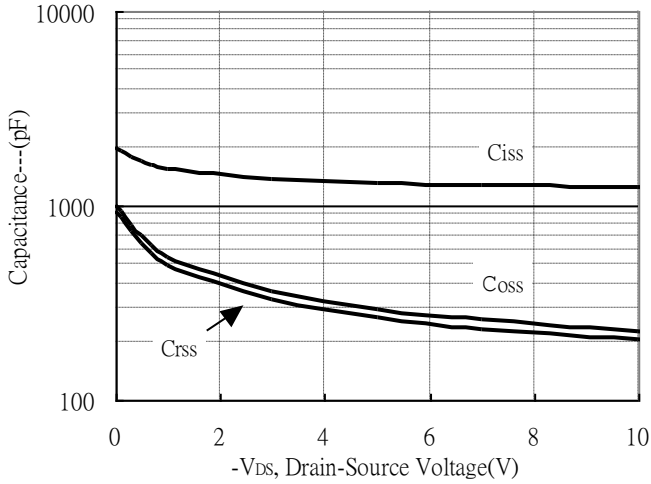

Threshold Voltage vs Junction Temperature

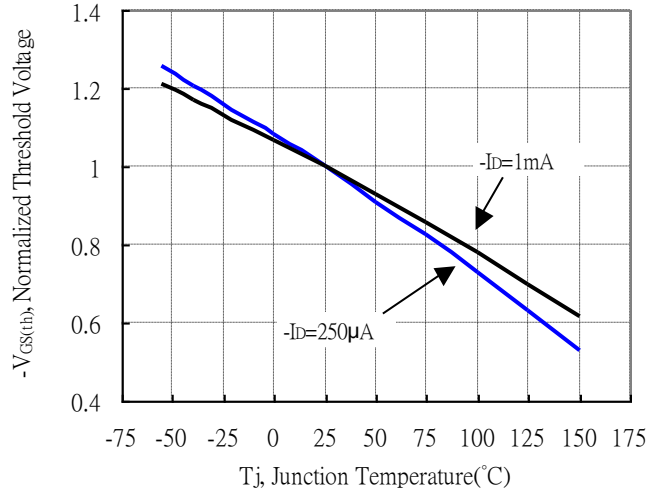

Forward Transfer Admittance vs Drain Current

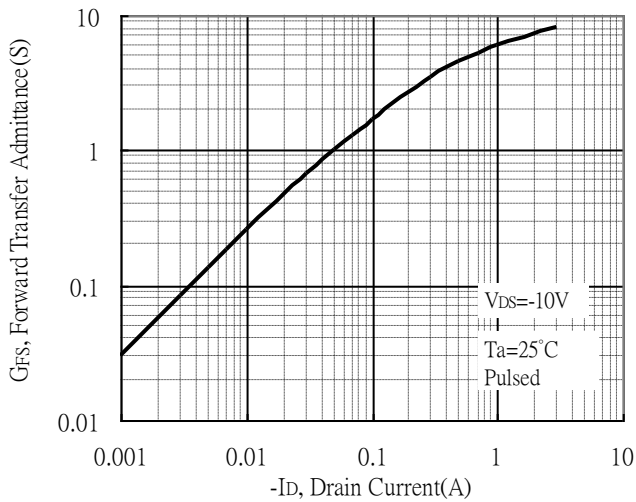

Maximum Drain Current vs Junction Temperature

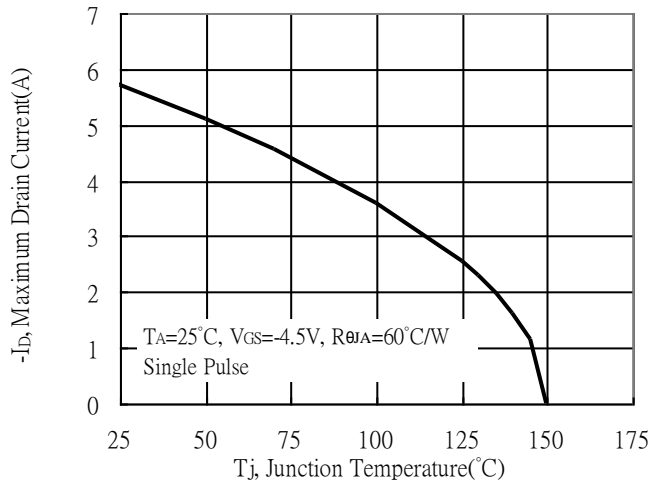

Maximum Safe Operating Area

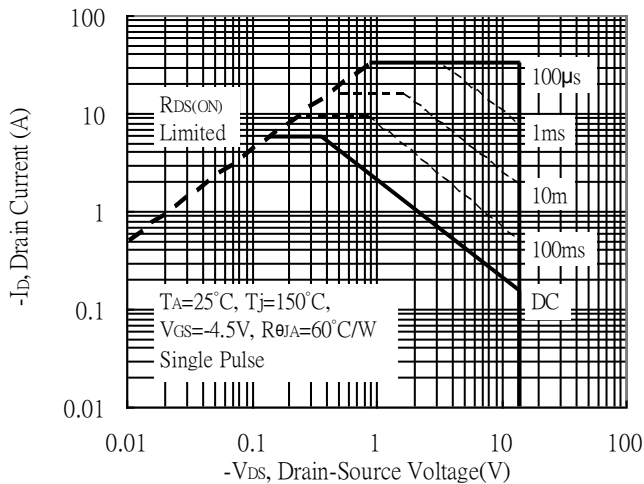

Gate Charge Characteristics

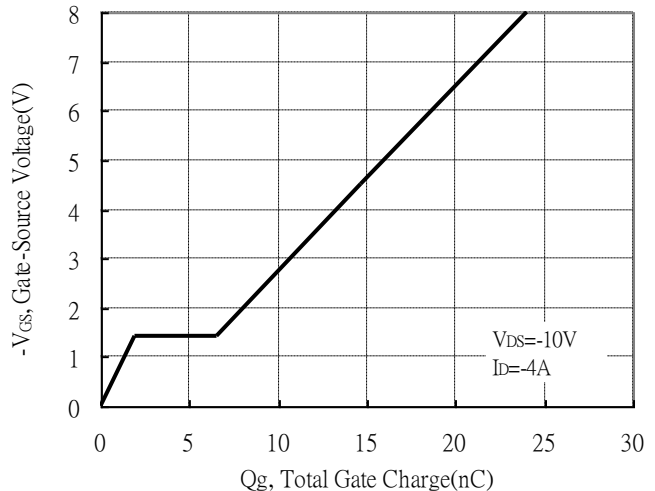



Typical Characteristics(Cont.)

Typical Transfer Characteristics

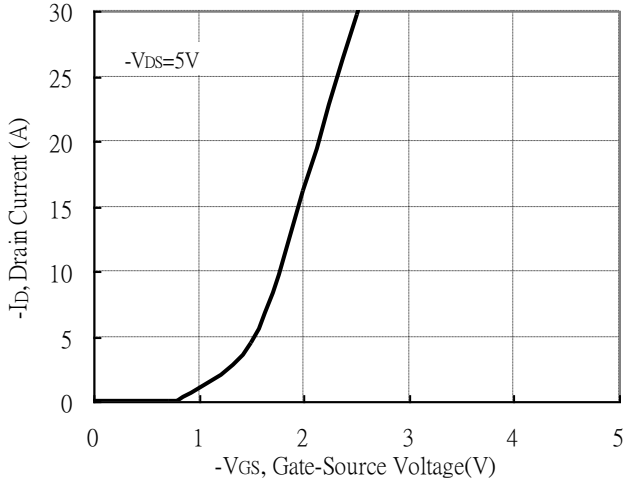

Single Pulse Power Rating, Junction to Case

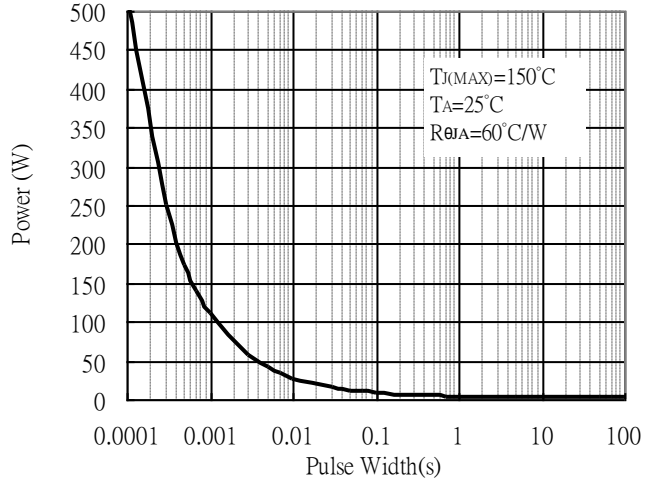

Transient Thermal Response Curves

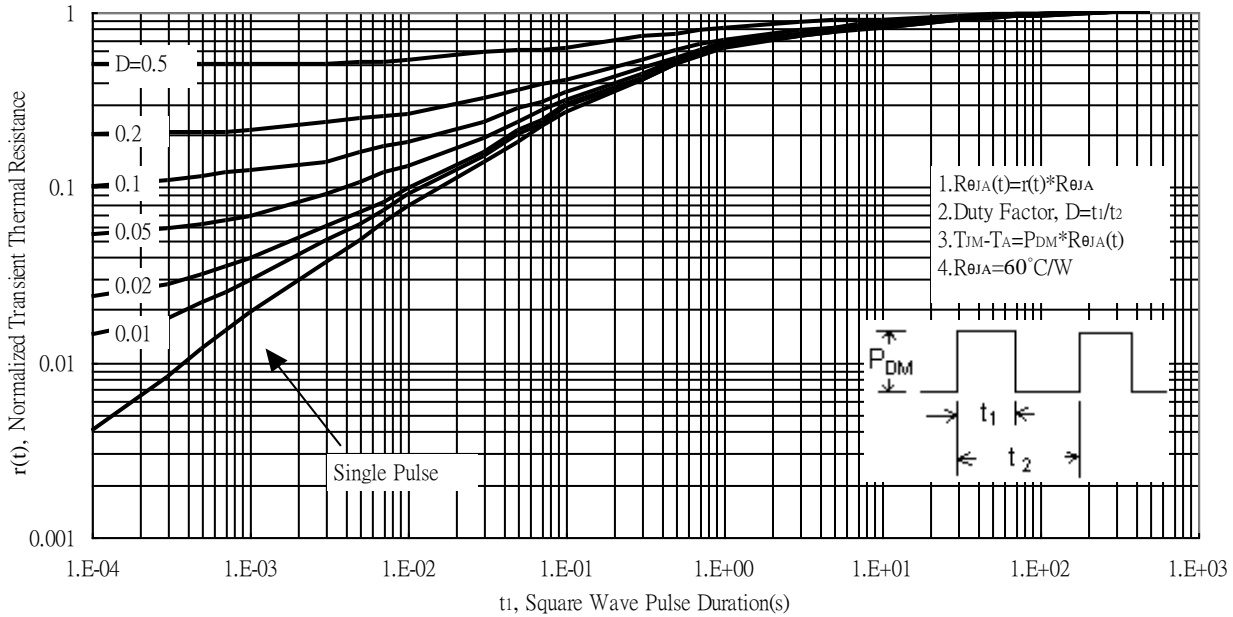

Reel Dimension

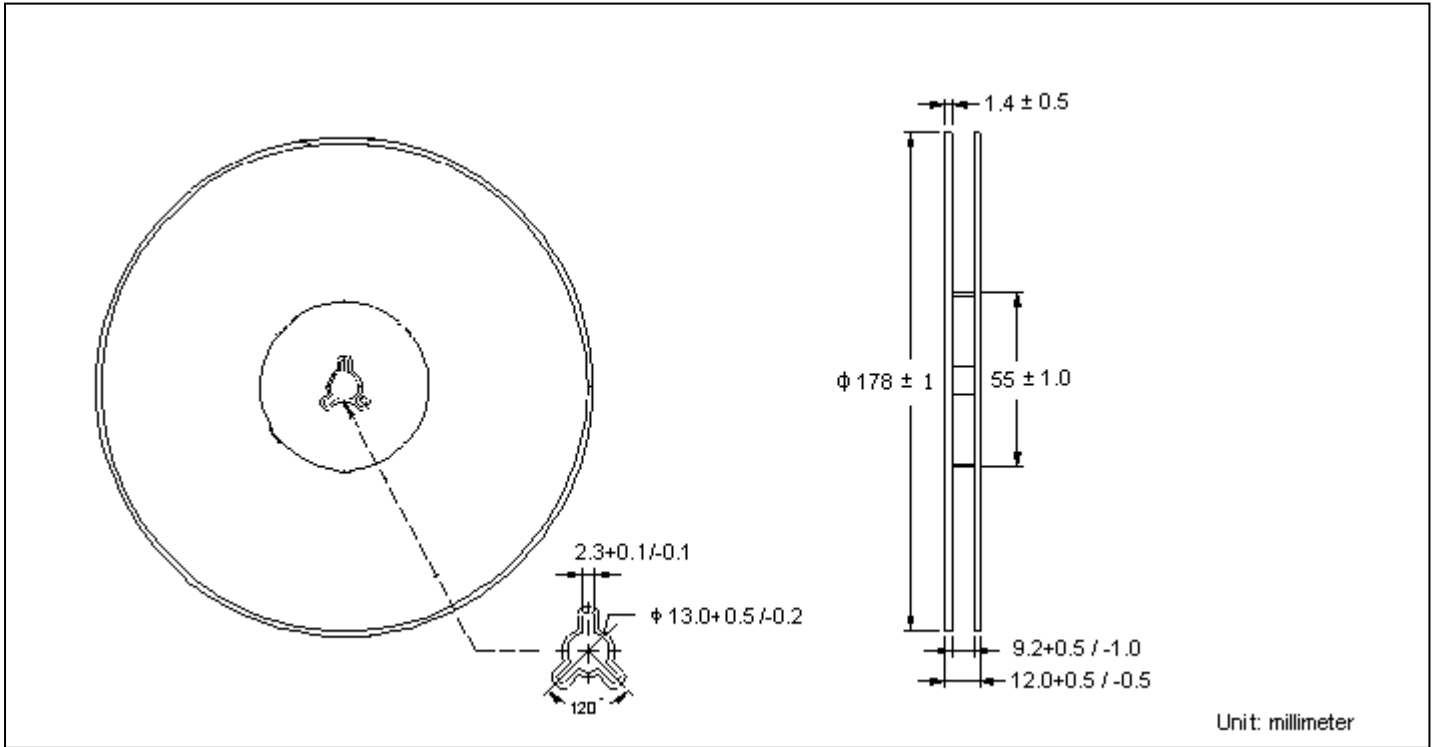

Carrier Tape Dimension

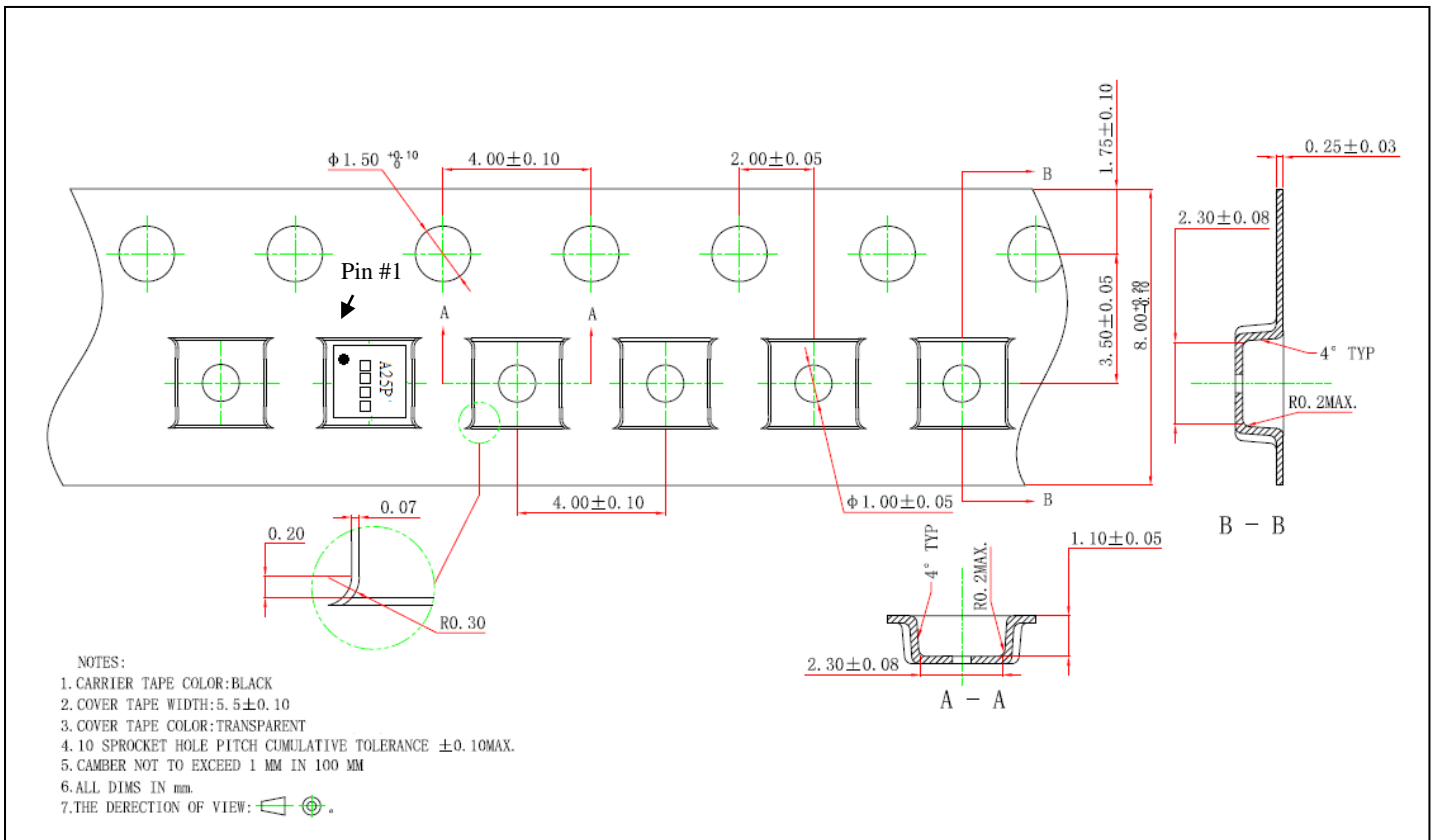

- NOTES:
1. CARRIER TAPE COLOR: BLACK
 2. COVER TAPE WIDTH: 5.5 ± 0.10
 3. COVER TAPE COLOR: TRANSPARENT
 4. 10 SPROCKET HOLE PITCH CUMULATIVE TOLERANCE ± 0.10 MAX.
 5. CAMBER NOT TO EXCEED 1 MM IN 100 MM
 6. ALL DIMS IN mm.
 7. THE DIRECTION OF VIEW:

Recommended wave soldering condition

Product	Peak Temperature	Soldering Time
Pb-free devices	260 +0/-5 °C	5 +1/-1 seconds

Recommended temperature profile for IR reflow

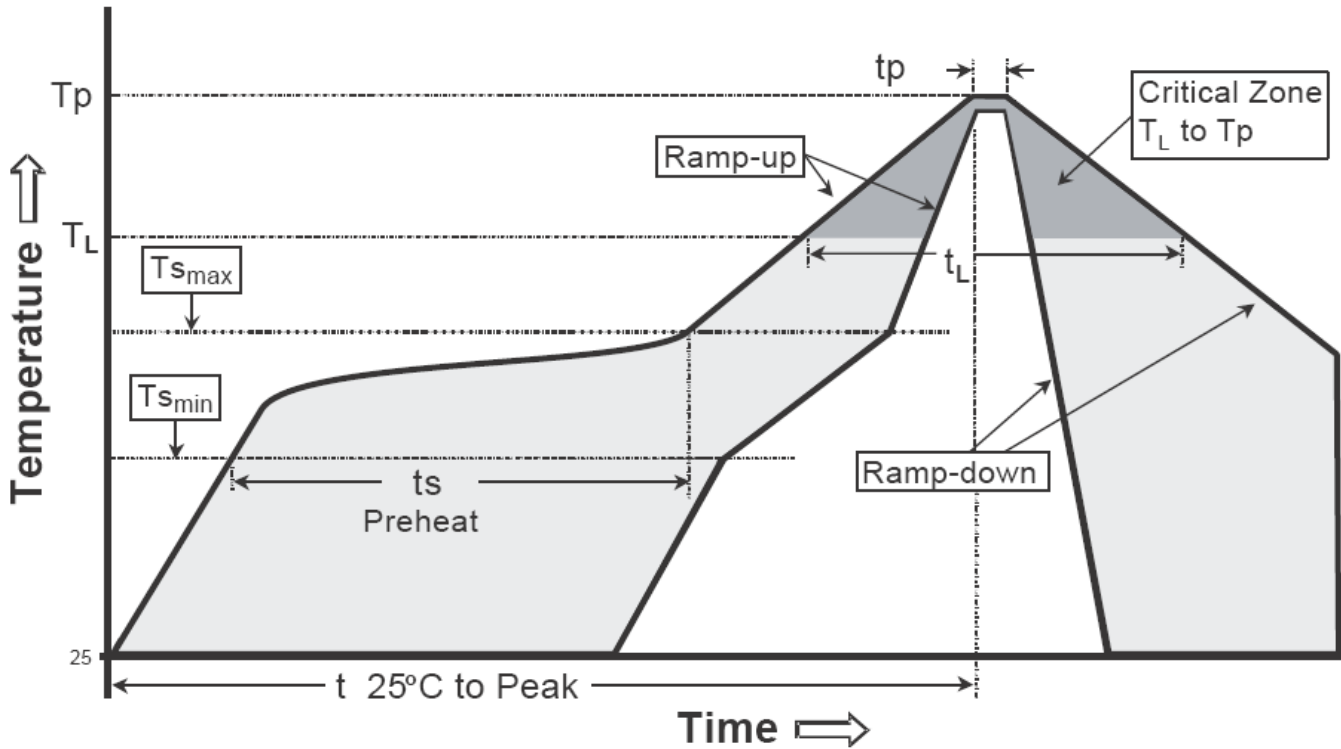

Profile feature	Sn-Pb eutectic Assembly	Pb-free Assembly
Average ramp-up rate (Tsmax to Tp)	3°C/second max.	3°C/second max.
Preheat		
-Temperature Min(Ts min)	100°C	150°C
-Temperature Max(Ts max)	150°C	200°C
-Time(ts min to ts max)	60-120 seconds	60-180 seconds
Time maintained above:		
-Temperature (Tl)	183°C	217°C
- Time (tl)	60-150 seconds	60-150 seconds
Peak Temperature(Tp)	240 +0/-5 °C	260 +0/-5 °C
Time within 5°C of actual peak temperature(tp)	10-30 seconds	20-40 seconds
Ramp down rate	6°C/second max.	6°C/second max.
Time 25 °C to peak temperature	6 minutes max.	8 minutes max.

Note : All temperatures refer to topside of the package, measured on the package body surface.

DFNWB2x2-6L-J Dimension

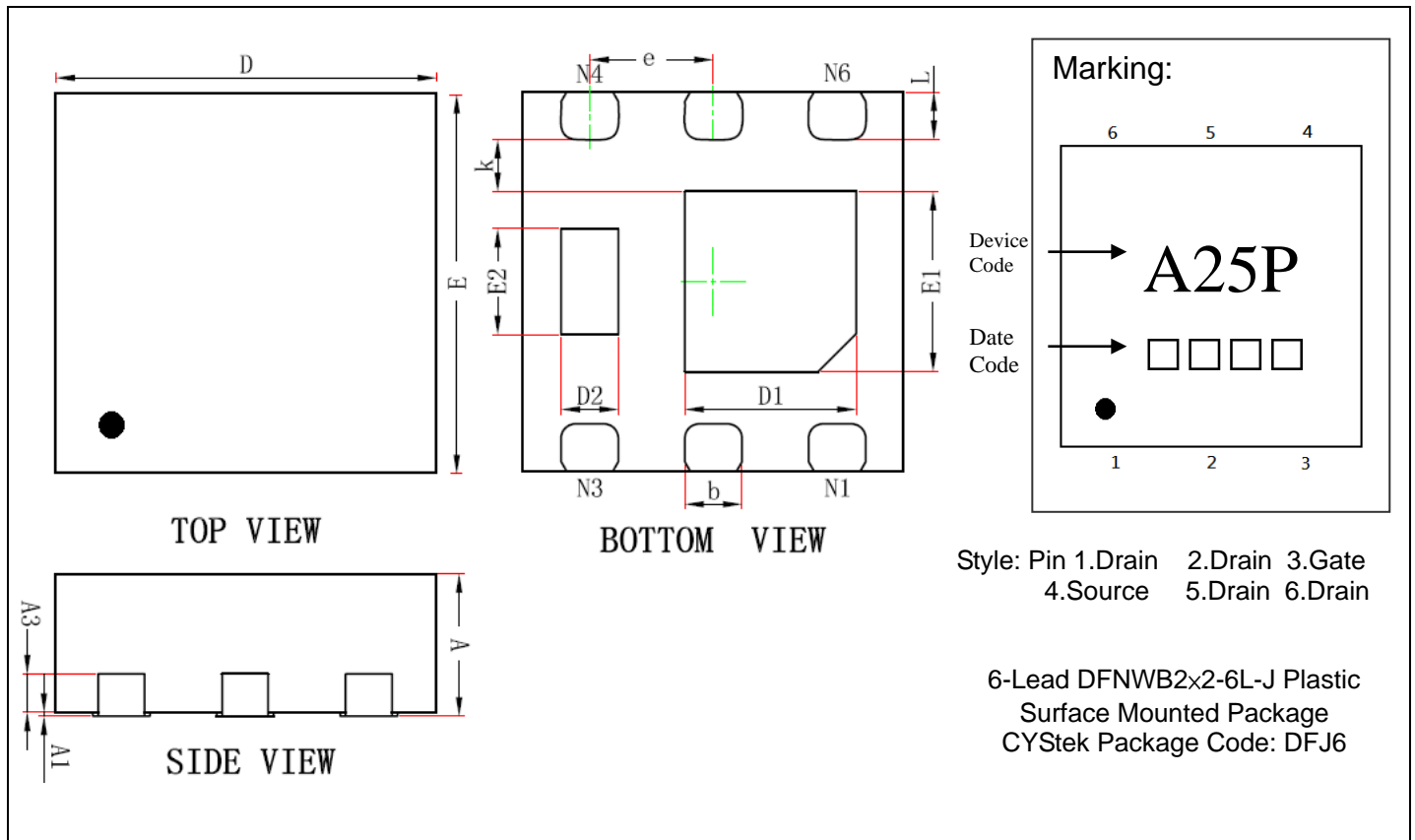

DIM	Millimeters		Inches		DIM	Millimeters		Inches	
	Min.	Max.	Min.	Max.		Min.	Max.	Min.	Max.
A	0.700	0.800	0.028	0.031	D2	0.200	0.400	0.008	0.016
A1	0.000	0.050	0.000	0.002	E2	0.460	0.660	0.018	0.026
A3	0.203	REF	0.008	REF	k	0.200	-	0.008	-
D	1.924	2.076	0.076	0.082	b	0.250	0.350	0.010	0.014
E	1.924	2.076	0.076	0.082	e	0.650	TYP	0.026	TYP
D1	0.800	1.000	0.031	0.039	L	0.174	0.326	0.007	0.013
E1	0.850	1.050	0.033	0.041					

Notes: 1.Controlling dimension: millimeters.
 2.Maximum lead thickness includes lead finish thickness, and minimum lead thickness is the minimum thickness of base material.
 3.If there is any question with packing specification or packing method, please contact your local CYStek sales office.

Material:

- Lead: Pure tin plated.
- Mold Compound: Epoxy resin family, flammability solid burning class: UL94V-0.

Important Notice:

- All rights are reserved. Reproduction in whole or in part is prohibited without the prior written approval of CYStek.
- CYStek reserves the right to make changes to its products without notice.
- CYStek **semiconductor products are not warranted to be suitable for use in Life-Support Applications, or systems.**
- CYStek assumes no liability for any consequence of customer product design, infringement of patents, or application assistance.