



30Amp. Schottky Barrier Rectifiers MBR30150E3

$I_{F(AV)}$	2 × 15A
V_{RRM}	150V
T_j	175°C
$V_{F(MAX)}$	0.75V

Features

- 175°C operating junction temperature
- Low V_F and low I_r type
- Metal silicon junction, major carrier conduction
- 30A total (15A per diode leg)
- Guardring for over voltage protection
- Low power loss, high efficiency
- High surge capability
- High temperature soldering guaranteed : 260°C/10s, 0.25”(6.35mm) from case
- For use in low voltage, high frequency inverters, free wheeling, and polarity protection application
- RoHS compliant package

Mechanical Data

- Case: JEDEC TO-220AB molded plastic
- Mounting Position: Any
- Weight: 0.08 ounce, 2.24 grams
- Terminals: Pure tin plated, lead-free, solderable per MIL-STD-750 method 2026
- Epoxy: UL 94V-0 rate flame retardant
- Mounting Torque : 5 in-lbs max

Ordering Information

Device	Package	Shipping
MBR30150E3-0-UB-X	TO-220 (Pb-free lead plating package)	50 pcs/tube, 20 tubes/box, 4 boxes / carton

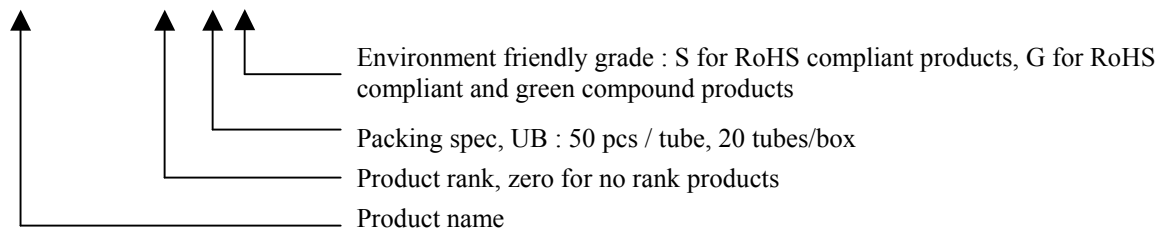

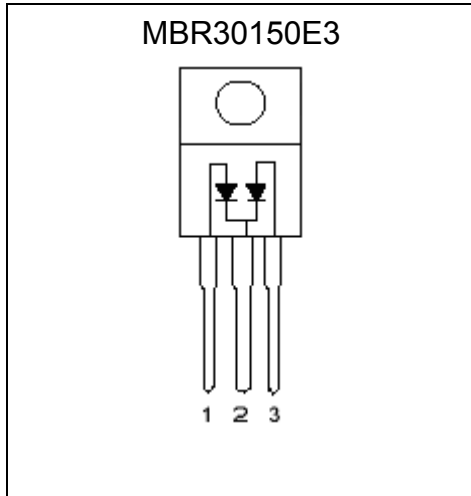
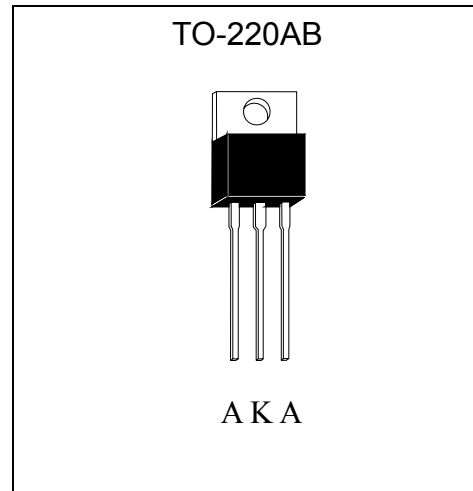
Equivalent Circuit

Outline

Maximum Ratings and Electrical Characteristics (Per Diode Leg)

(Rating at 25°C ambient temperature unless otherwise specified. Single phase, half wave, 60Hz, resistive or inductive load. For capacitive load, derate current by 20%.)

Parameter	Symbol	Value	Units
Maximum Recurrent peak reverse voltage	V_{RRM}	150	V
Maximum RMS voltage	V_{RMS}	105	V
Maximum DC blocking voltage	V_{DC}	150	V
Maximum instantaneous forward voltage at (Note 1)	V_F	$I_F=15A, T_C=25^\circ C$	0.92
		$I_F=15A, T_C=125^\circ C$	0.75
		$I_F=30A, T_C=25^\circ C$	1
		$I_F=30A, T_C=125^\circ C$	0.86
Maximum Average forward rectified current @ $T_C=130^\circ C$	Per Diode	15	A
	Per Device	30	
Non-repetitive peak forward surge current @ 8.3ms single half sine wave superimposed on rated load (JEDEC method)	I_{FSM}	180	A
Peak repetitive reverse surge current, $T_J < 175^\circ C$ (Note 1)	I_{RRM}	4	A
Maximum instantaneous reverse current at	I_R	$V_R=150V, T_C=25^\circ C$	5
		$V_R=150V, T_C=125^\circ C$	10
Voltage rate of change, (rated V_R)	dV/dt	10,000	V/ μs
Typical junction capacitance @ $f=1MHz$ and applied 5V reverse voltage	C_J	230 (typ.)	pF
ESD susceptibility (Note 2)		8000	V
Storage temperature range	T_{stg}	-65~ +175	$^\circ C$
Operating junction temperature range	T_J	-65~ +175	$^\circ C$

Notes : 1. 2.0 μs pulse width, $f=1.0kHz$

2. Human body model, 1.5k Ω in series with 100pF



Thermal Data

Parameter	Symbol	Value	Unit
Maximum Thermal Resistance, Junction-to-case	$R_{th,j-c}$	1.7	$^{\circ}C/W$
Maximum Thermal Resistance, Junction-to-ambient	$R_{th,j-a}$	45	$^{\circ}C/W$

Typical Characteristics

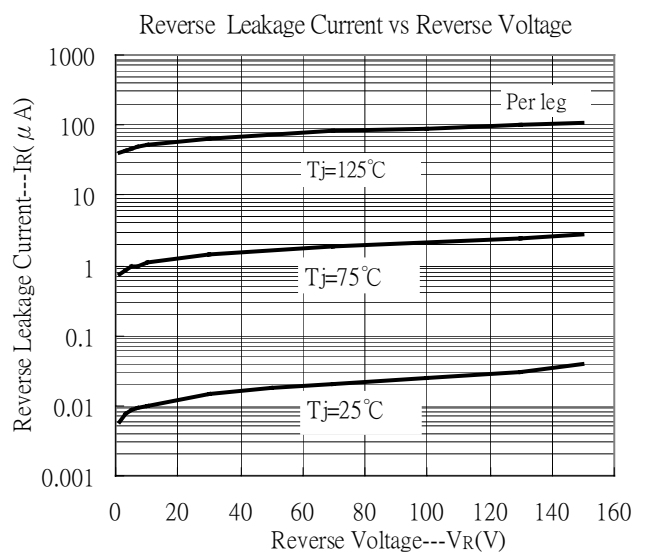
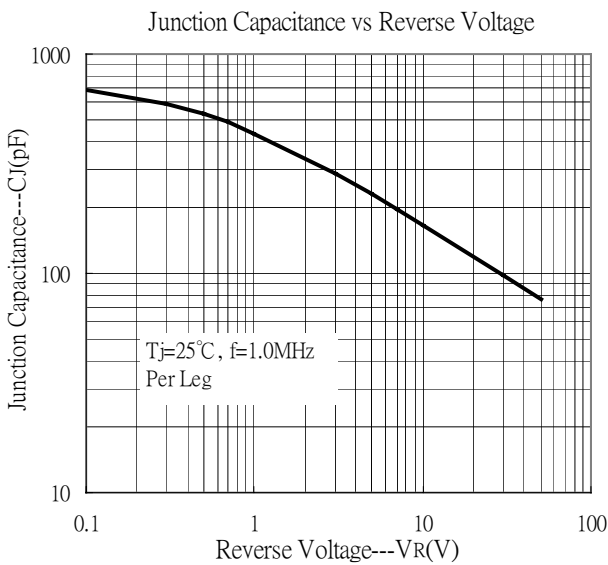
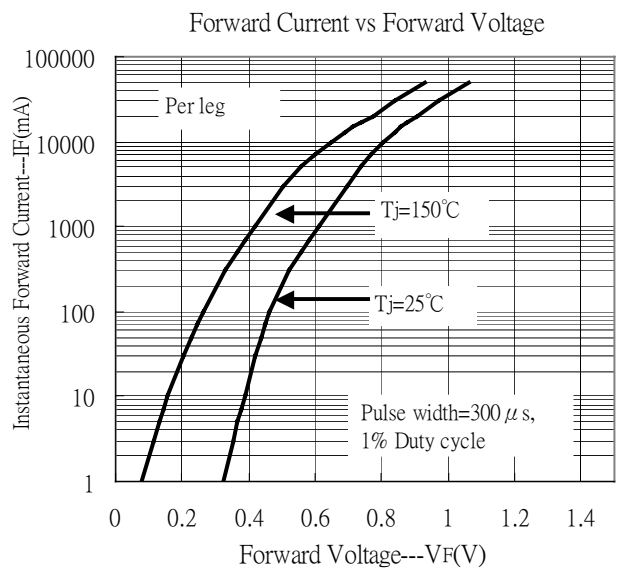
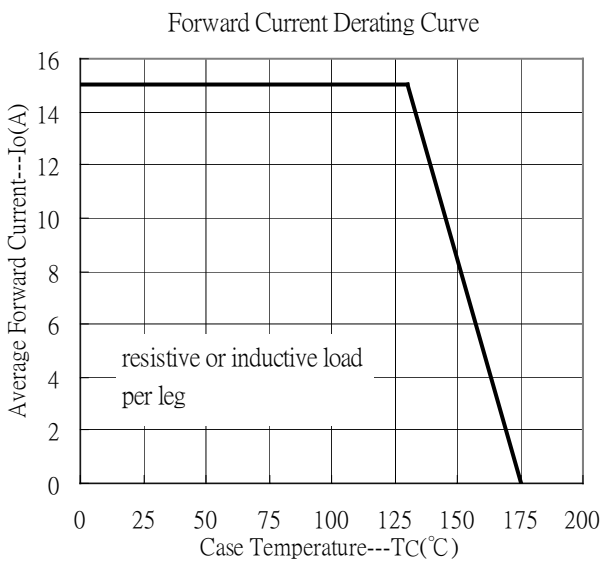

Recommended wave soldering condition

Product	Peak Temperature	Soldering Time
Pb-free devices	260 +0/-5 °C	5 +1/-1 seconds

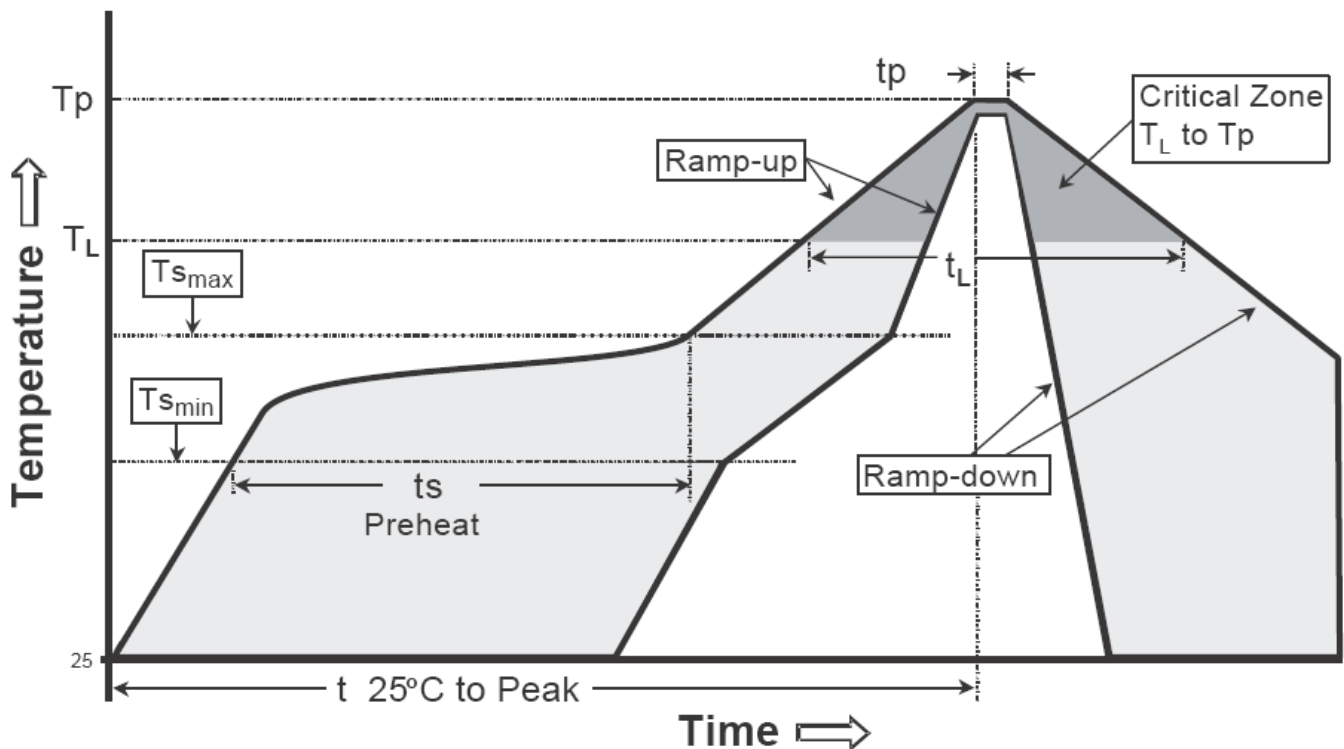
Recommended temperature profile for IR reflow

Profile feature	Sn-Pb eutectic Assembly	Pb-free Assembly
Average ramp-up rate (T _{smax} to T _p)	3°C/second max.	3°C/second max.
Preheat		
-Temperature Min(T _{s min})	100°C	150°C
-Temperature Max(T _{s max})	150°C	200°C
-Time(t _{s min} to t _{s max})	60-120 seconds	60-180 seconds
Time maintained above:		
-Temperature (T _L)	183°C	217°C
- Time (t _L)	60-150 seconds	60-150 seconds
Peak Temperature(T _p)	240 +0/-5 °C	260 +0/-5 °C
Time within 5°C of actual peak temperature(t _p)	10-30 seconds	20-40 seconds
Ramp down rate	6°C/second max.	6°C/second max.
Time 25 °C to peak temperature	6 minutes max.	8 minutes max.

Note : All temperatures refer to topside of the package, measured on the package body surface.

TO-220AB Dimension

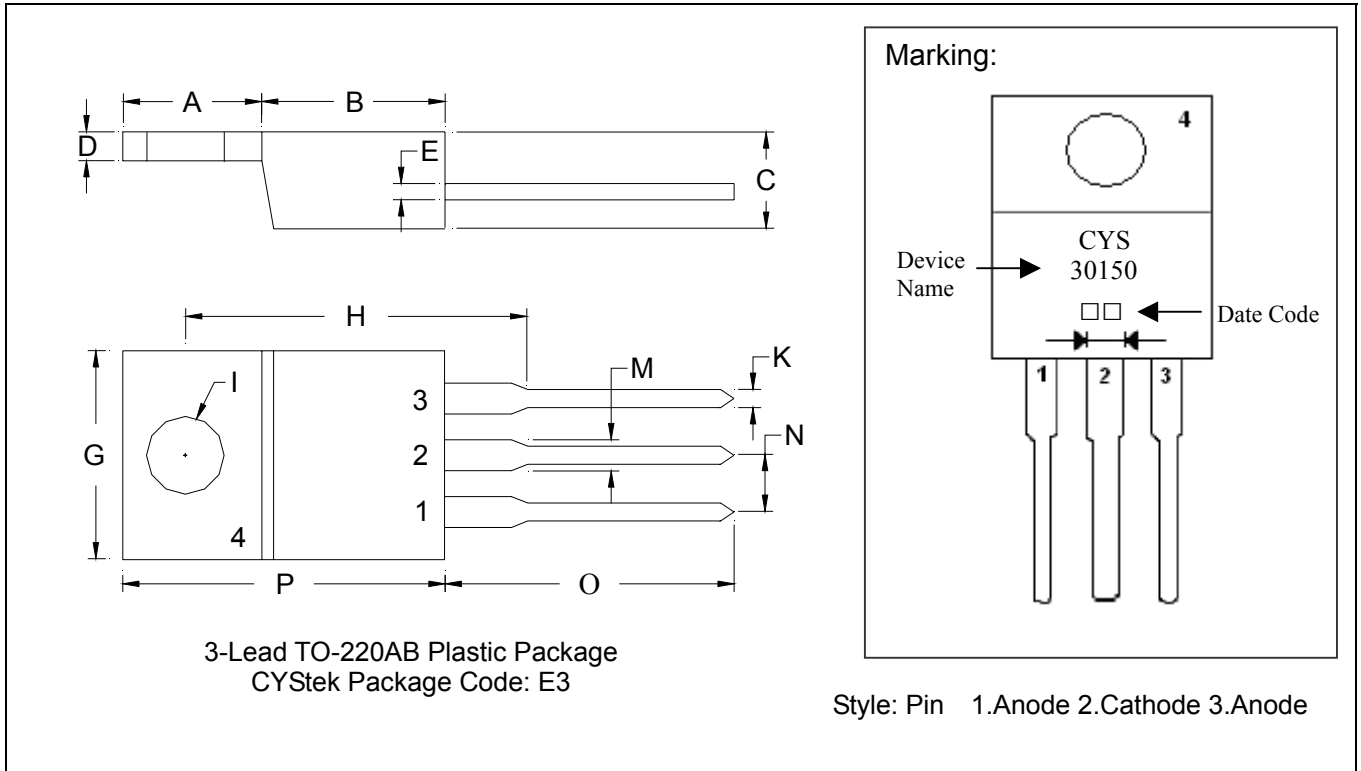

*: Typical

DIM	Inches		Millimeters		DIM	Inches		Millimeters	
	Min.	Max.	Min.	Max.		Min.	Max.	Min.	Max.
A	0.2197	0.2949	5.58	7.49	I	-	*0.1508	-	*3.83
B	0.3299	0.3504	8.38	8.90	K	0.0295	0.0374	0.75	0.95
C	0.1732	0.185	4.40	4.70	M	0.0449	0.0551	1.14	1.40
D	0.0453	0.0547	1.15	1.39	N	-	*0.1000	-	*2.54
E	0.0138	0.0236	0.35	0.60	O	0.5000	0.5618	12.70	14.27
G	0.3803	0.4047	9.66	10.28	P	0.5701	0.6248	14.48	15.87
H	-	*0.6398	-	*16.25					

- Notes: 1.Controlling dimension: millimeters.
 2.Maximum lead thickness includes lead finish thickness, and minimum lead thickness is the minimum thickness of base material.
 3.If there is any question with packing specification or packing method, please contact your local CYStek sales office.

Material:

- Lead: tin plated
- Mold Compound: Epoxy resin family, flammability solid burning class: UL94V-0

Important Notice:

- All rights are reserved. Reproduction in whole or in part is prohibited without the prior written approval of CYStek.
- CYStek reserves the right to make changes to its products without notice.
- CYStek **semiconductor products are not warranted to be suitable for use in Life-Support Applications, or systems.**
- CYStek assumes no liability for any consequence of customer product design, infringement of patents, or application assistance.