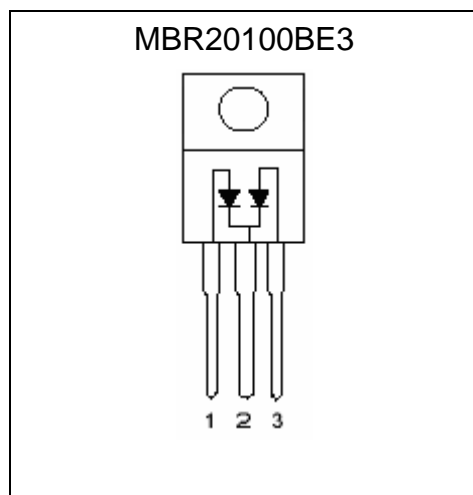
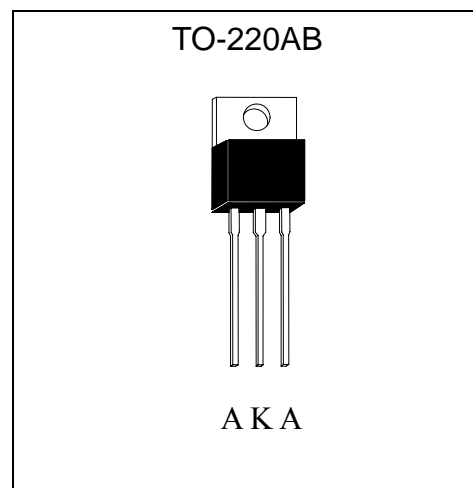

**20Amp. Schottky Barrier Rectifiers****MBR20100BE3****Features**

- Low  $V_F$  and low  $I_R$  type
- Metal silicon junction, major carrier conduction
- High current capability
- Guardring for over voltage protection
- Low power loss, high efficiency
- High surge capability
- High temperature soldering guaranteed :  $260^{\circ}\text{C}/10\text{s}$ ,  $0.25''(6.35\text{mm})$  from case
- For use in low voltage, high frequency inverters, free wheeling, and polarity protection application
- RoHS compliant and Halogen-free package

**Mechanical Data**

- Case: JEDEC TO-220AB molded plastic
- Mounting Position: Any
- Weight: 0.08 ounce, 2.24 grams
- Terminals: Pure tin plated, lead-free, solderable per MIL-STD-750 method 2026
- Epoxy: UL 94V-0 rate flame retardant
- Mounting Torque : 5 in-lbs max

**Equivalent Circuit****Outline**

**Maximum Ratings and Electrical Characteristics (Per Diode Leg)**

(Rating at 25°C ambient temperature unless otherwise specified. Single phase, half wave, 60Hz, resistive or inductive load. For capacitive load, derate current by 20%.)

Parameter	Symbol	Limits	Units
Maximum Recurrent peak reverse voltage	V <sub>RRM</sub>	100	V
Maximum RMS voltage	V <sub>RMS</sub>	70	V
Maximum DC blocking voltage	V <sub>DC</sub>	100	V
Maximum instantaneous forward voltage at (Note 1)	V <sub>F</sub>	I <sub>F</sub> =10A, T <sub>C</sub> =25°C 0.85	V
		I <sub>F</sub> =10A, T <sub>C</sub> =125°C 0.75	
		I <sub>F</sub> =20A, T <sub>C</sub> =25°C 0.95	
		I <sub>F</sub> =20A, T <sub>C</sub> =125°C 0.85	
Maximum Average forward rectified current @ T <sub>C</sub> =145°C	Per Diode	10	A
	Per Device	20	
Peak repetitive forward current (Rated V <sub>R</sub> , square wave, 20kHz) @T <sub>C</sub> =135°C	I <sub>FRM</sub>	20	A
Peak forward surge current @8.3ms single half sine wave superimposed on rated load (JEDEC method)	I <sub>FSM</sub>	135	A
Peak repetitive reverse surge current (Note 1), T <sub>J</sub> <175°C	I <sub>RRM</sub>	3.5	A
Maximum instantaneous reverse current at	I <sub>R</sub>	V <sub>R</sub> =100V, T <sub>C</sub> = 25°C 5.0	μA
		V <sub>R</sub> =100V, T <sub>C</sub> = 125°C 5.0	mA
Voltage rate of change, (rated V <sub>R</sub> )	dV/dt	10,000	V/μs
Typical junction capacitance @ f=1MHz and applied 4V reverse voltage	C <sub>J</sub>	190	pF
ESD susceptibility (Note 2)		8000	V
Storage temperature range	T <sub>stg</sub>	-55 ~ +175	°C
Operating junction temperature range	T <sub>J</sub>	-65 ~ +175	°C

Notes : 1. 2.0μs pulse width, f=1.0kHz

2. Human body model, 1.5kΩ in series with 100pF

**Thermal Data**

Parameter	Symbol	Value	Unit
Maximum Thermal Resistance, Junction-to-case	R <sub>th,j-c</sub>	2	°C/W
Maximum Thermal Resistance, Junction-to-ambient	R <sub>th,j-a</sub>	60	°C/W

**Ordering Information**

Device	Package	Shipping	Marking
MBR20100BE3	TO-220AB (Pb-free)	50 pcs / Tube, 40 Tubes/Box	20100B

## Characteristic Curves

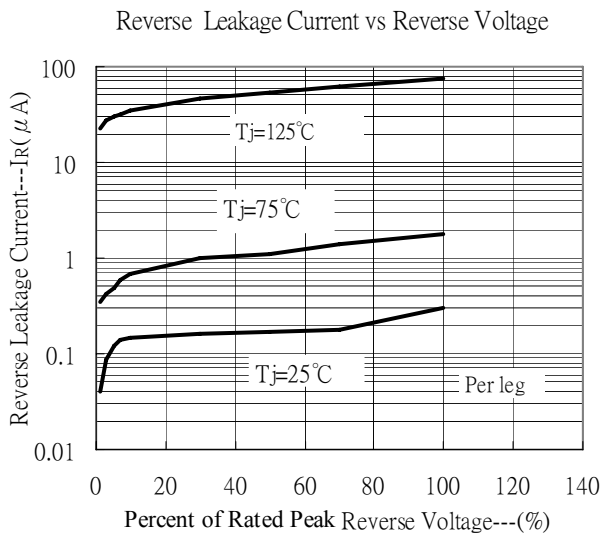
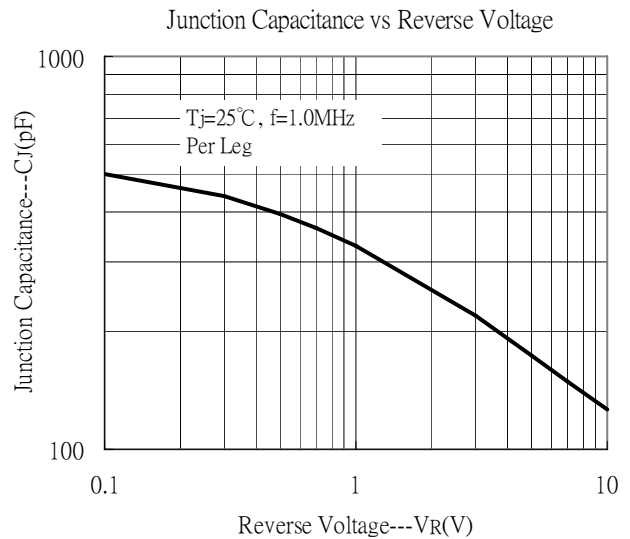
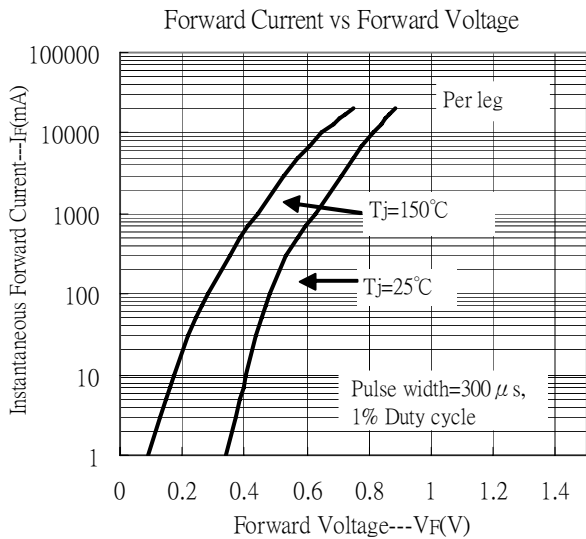
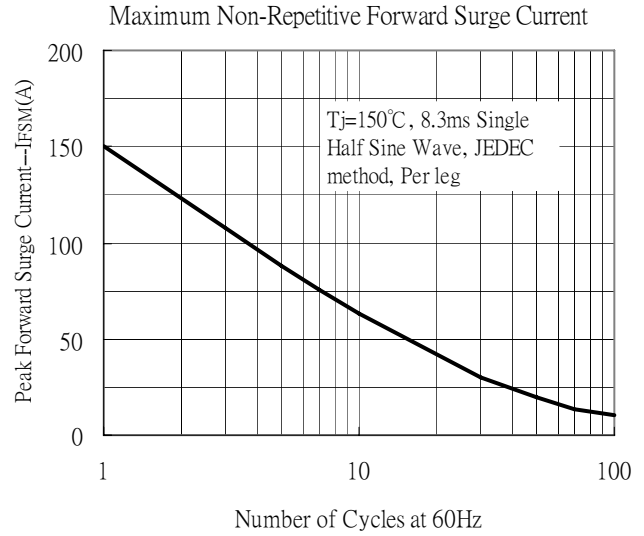
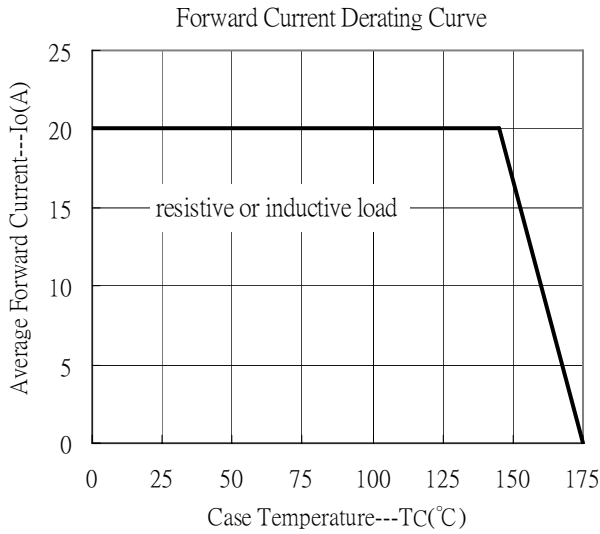

## TO-220AB Dimension

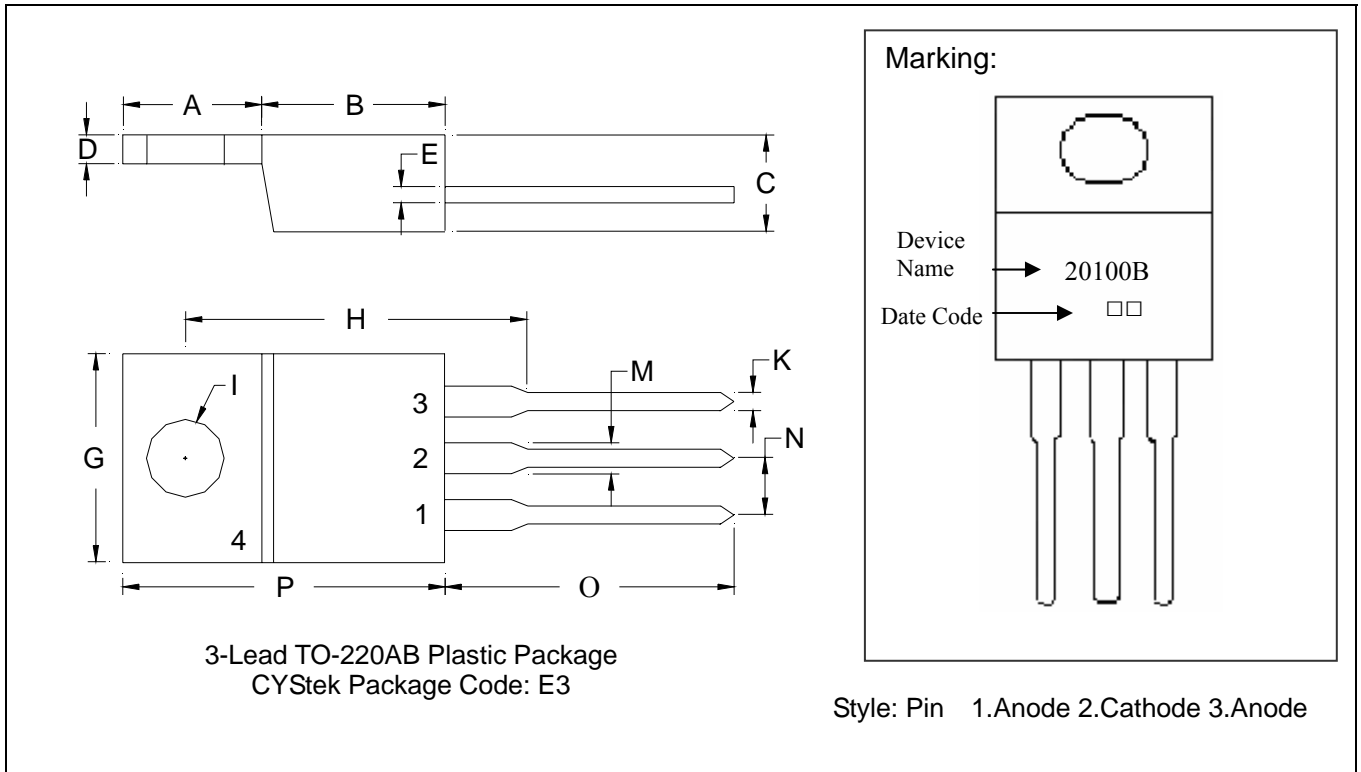

\*: Typical

DIM	Inches		Millimeters		DIM	Inches		Millimeters	
	Min.	Max.	Min.	Max.		Min.	Max.	Min.	Max.
A	0.2197	0.2949	5.58	7.49	I	-	*0.1508	-	*3.83
B	0.3299	0.3504	8.38	8.90	K	0.0295	0.0374	0.75	0.95
C	0.1732	0.185	4.40	4.70	M	0.0449	0.0551	1.14	1.40
D	0.0453	0.0547	1.15	1.39	N	-	*0.1000	-	*2.54
E	0.0138	0.0236	0.35	0.60	O	0.5000	0.5618	12.70	14.27
G	0.3803	0.4047	9.66	10.28	P	0.5701	0.6248	14.48	15.87
H	-	*0.6398	-	*16.25					

Notes: 1.Controlling dimension: millimeters.

2.Maximum lead thickness includes lead finish thickness, and minimum lead thickness is the minimum thickness of base material.

3.If there is any question with packing specification or packing method, please contact your local CYStek sales office.

**Material:**

- Lead: KFC ; tin plated
- Mold Compound: Epoxy resin family, flammability solid burning class: UL94V-0

**Important Notice:**

- All rights are reserved. Reproduction in whole or in part is prohibited without the prior written approval of CYStek.
- CYStek reserves the right to make changes to its products without notice.
- CYStek **semiconductor products are not warranted to be suitable for use in Life-Support Applications, or systems.**
- CYStek assumes no liability for any consequence of customer product design, infringement of patents, or application assistance.