

Three Terminal Positive Voltage Regulators

LM78XXE3

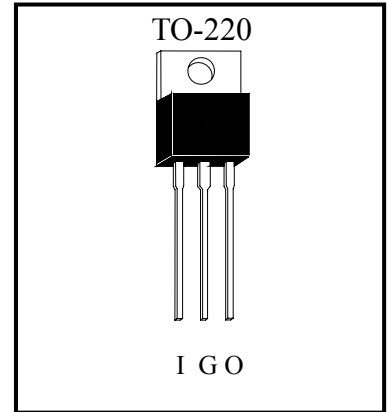

Description

The LM78XXE3 series of fixed voltage monolithic integrated circuit voltage regulators is designed for a wide range of applications. These applications include on-card regulation for elimination of noise and distribution problems associated with single point regulation. Each of these regulators can deliver up to 1.5A of output current. The internal current limiting and thermal shutdown features of these regulators make them essentially immune to overload.

Features:

- 5V, 6V, 8V, 9V, 10V, 12V, 15V, 18V, 24V output voltage available
- Internal Short-Circuit Current Limiting
- High Power Dissipation Capability
- Internal Thermal Overload Protection
- No External Components Required
- Output Transistor Safe Area Compensation
- RoHS compliant package

Absolute Maximum Ratings (Ta=25°C)

Parameter		Ratings	Unit
Input Voltage	LM7805~LM7818	35	V
	LM7824	40	
Output Current		1.5	A
Operating Junction Temperature Range		-40 ~ +125	°C
Storage Temperature Range		-55 ~ +150	°C
Thermal Resistance, Junction to Ambient (RθJA)		65	°C/W
Thermal Resistance, Junction to Case (RθJC)		5	°C/W

Ordering Information

Device	Package	Shipping
LM78XXE3-X-UB-S	TO-220 (Pb-free lead plating package)	50 pcs/tube, 20 tubes/box, 4 boxes / carton

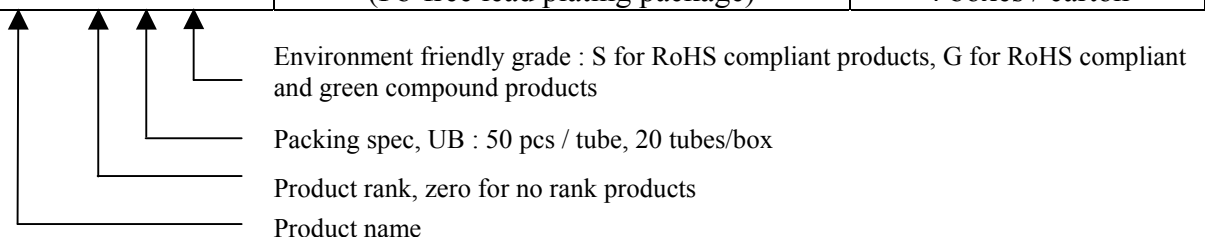

Typical Application

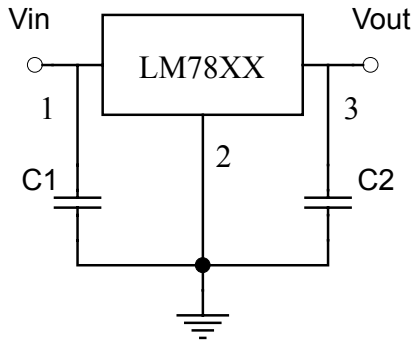

Note:
 C1 and C2 are required if regulator is located far from power supply filter and load, or oscillation may induced on the loop.

Electrical Characteristics

LM7805 ($T_j=0\sim 125^\circ\text{C}$, $V_{in}=10\text{V}$, $I_o=500\text{mA}$, $C_{in}=0.33\mu\text{F}$, $C_{out}=0.1\mu\text{F}$, unless otherwise noted)

Symbol	Parameter	Min	Typ	Max	Conditions	Units
V_o	Output Voltage	4.85	5.0	5.15	$V_{in}=10\text{V}$, $I_o=500\text{mA}$, $T_j=25^\circ\text{C}$ $7.5\text{V}\leq V_{in}\leq 20\text{V}$, $5\text{mA}\leq I_o\leq 1\text{A}$, $PD\leq 15\text{W}$	V
		4.75	-	5.25		
ΔV_o	Line Regulation	-	3	50	$7\text{V}\leq V_{in}\leq 25\text{V}$, $T_j=25^\circ\text{C}$	mV
		-	1	25	$8\text{V}\leq V_{in}\leq 12\text{V}$, $T_j=25^\circ\text{C}$	
ΔV_o	Load Regulation	-	-	100	$5\text{mA}\leq I_o\leq 1.5\text{A}$, $T_j=25^\circ\text{C}$	mV
		-	-	50	$250\text{mA}\leq I_o\leq 750\text{mA}$, $T_j=25^\circ\text{C}$	
I_Q	Quiescent Current	-	-	8	$V_{in}=10\text{V}$, $I_o=500\text{mA}$, $T_j=25^\circ\text{C}$	mA
ΔI_Q	Quiescent Current Change	-	-	0.5	$5\text{mA}\leq I_o\leq 1\text{A}$	mA
		-	-	1.3	$7\text{V}\leq V_{in}\leq 25\text{V}$	
V_n	Output Noise Voltage	-	40	-	$10\text{Hz}\leq f\leq 100\text{KHz}$, $T_j=25^\circ\text{C}$	μV
RR	Ripple Rejection	-	80	-	$8\text{V}\leq V_{in}\leq 18\text{V}$, $f=120\text{Hz}$, $T_j=25^\circ\text{C}$	dB
VD	Dropout Voltage	-	2	-	$I_o=1\text{A}$, $T_j=25^\circ\text{C}$	V
ISC	Output Short Circuit Current	-	250	-	$V_{in}=35\text{V}$, $T_j=25^\circ\text{C}$	mA
IPK	Peak Output Current	-	1.8	-	$T_j=25^\circ\text{C}$	A
$\Delta V_o/\Delta T_j$	Temperature Stability	-	-0.6	-	$I_o=5\text{mA}$, $0^\circ\text{C}\leq T_j\leq 125^\circ\text{C}$	$\text{mV}/^\circ\text{C}$



LM7806 ($T_j=0\sim 125^\circ\text{C}$, $V_{in}=11\text{V}$, $I_o=500\text{mA}$, $C_{in}=0.33\mu\text{F}$, $C_{out}=0.1\mu\text{F}$, unless otherwise noted)

Symbol	Parameter	Min	Typ	Max	Conditions	Units	
V_o	A-rank(3%)	Output Voltage	5.82	6.0	6.18	$V_{in}=11\text{V}$, $I_o=500\text{mA}$, $T_j=25^\circ\text{C}$ $8\text{V}\leq V_{in}\leq 21\text{V}$, $5\text{mA}\leq I_o\leq 1\text{A}$, $PD\leq 15\text{W}$	V
	B-rank(5%)		5.70	-	6.30		
ΔV_o	Line Regulation	-	3	60	$8\text{V}\leq V_{in}\leq 25\text{V}$, $T_j=25^\circ\text{C}$	mV	
		-	1	25	$9\text{V}\leq V_{in}\leq 13\text{V}$, $T_j=25^\circ\text{C}$		
ΔV_o	Load Regulation	-	-	100	$5\text{mA}\leq I_o\leq 1.5\text{A}$, $T_j=25^\circ\text{C}$	mV	
		-	-	50	$250\text{mA}\leq I_o\leq 750\text{mA}$, $T_j=25^\circ\text{C}$		
I_Q	Quiescent Current	-	-	8	$V_{in}=11\text{V}$, $I_o=500\text{mA}$, $T_j=25^\circ\text{C}$	mA	
ΔI_Q	Quiescent Current Change	-	-	0.5	$5\text{mA}\leq I_o\leq 1\text{A}$	mA	
		-	-	1.3	$8\text{V}\leq V_{in}\leq 25\text{V}$		
V_n	Output Noise Voltage	-	45	-	$10\text{Hz}\leq f\leq 100\text{KHz}$, $T_j=25^\circ\text{C}$	μV	
RR	Ripple Rejection	-	75	-	$9\text{V}\leq V_{in}\leq 19\text{V}$, $f=120\text{Hz}$, $T_j=25^\circ\text{C}$	dB	
VD	Dropout Voltage	-	2	-	$I_o=1\text{A}$, $T_j=25^\circ\text{C}$	V	
ISC	Output Short Circuit Current	-	250	-	$V_{in}=35\text{V}$, $T_j=25^\circ\text{C}$	mA	
IPK	Peak Output Current	-	1.8	-	$T_j=25^\circ\text{C}$	A	
$\Delta V_o/\Delta T_j$	Temperature Stability	-	-0.7	-	$I_o=5\text{mA}$, $0^\circ\text{C}\leq T_j\leq 125^\circ\text{C}$	$\text{mV}/^\circ\text{C}$	

LM7808 ($T_j=0\sim 125^\circ\text{C}$, $V_{in}=14\text{V}$, $I_o=500\text{mA}$, $C_{in}=0.33\mu\text{F}$, $C_{out}=0.1\mu\text{F}$, unless otherwise noted)

Symbol	Parameter	Min	Typ	Max	Conditions	Units	
V_o	A-rank(3%)	Output Voltage	7.76	8.0	8.24	$V_{in}=14\text{V}$, $I_o=500\text{mA}$, $T_j=25^\circ\text{C}$ $10.5\text{V}\leq V_{in}\leq 23\text{V}$, $5\text{mA}\leq I_o\leq 1\text{A}$, $PD\leq 15\text{W}$	V
	B-rank(5%)		7.60	-	8.40		
ΔV_o	Line Regulation	-	3	80	$10.5\text{V}\leq V_{in}\leq 25\text{V}$, $T_j=25^\circ\text{C}$	mV	
		-	1	40	$11\text{V}\leq V_{in}\leq 17\text{V}$, $T_j=25^\circ\text{C}$		
ΔV_o	Load Regulation	-	-	100	$5\text{mA}\leq I_o\leq 1.5\text{A}$, $T_j=25^\circ\text{C}$	mV	
		-	-	50	$250\text{mA}\leq I_o\leq 750\text{mA}$, $T_j=25^\circ\text{C}$		
I_Q	Quiescent Current	-	-	8	$V_{in}=14\text{V}$, $I_o=500\text{mA}$, $T_j=25^\circ\text{C}$	mA	
ΔI_Q	Quiescent Current Change	-	-	0.5	$5\text{mA}\leq I_o\leq 1\text{A}$	mA	
		-	-	1.3	$10.5\text{V}\leq V_{in}\leq 25\text{V}$		
V_n	Output Noise Voltage	-	58	-	$10\text{Hz}\leq f\leq 100\text{KHz}$, $T_j=25^\circ\text{C}$	μV	
RR	Ripple Rejection	-	72	-	$11.5\text{V}\leq V_{in}\leq 21.5\text{V}$, $f=120\text{Hz}$, $T_j=25^\circ\text{C}$	dB	
VD	Dropout Voltage	-	2	-	$I_o=1\text{A}$, $T_j=25^\circ\text{C}$	V	
ISC	Output Short Circuit Current	-	250	-	$V_{in}=35\text{V}$, $T_j=25^\circ\text{C}$	mA	
IPK	Peak Output Current	-	1.8	-	$T_j=25^\circ\text{C}$	A	
$\Delta V_o/\Delta T_j$	Temperature Stability	-	-0.9	-	$I_o=5\text{mA}$, $0^\circ\text{C}\leq T_j\leq 125^\circ\text{C}$	$\text{mV}/^\circ\text{C}$	



LM7809 ($T_j=0\sim 125^{\circ}\text{C}$, $V_{in}=15\text{V}$, $I_o=500\text{mA}$, $C_{in}=0.33\mu\text{F}$, $C_{out}=0.1\mu\text{F}$, unless otherwise noted)

Symbol	Parameter	Min	Typ	Max	Conditions	Units	
V_o	A-rank(3%)	Output Voltage	8.73	9.0	9.27	$V_{in}=15\text{V}$, $I_o=500\text{mA}$, $T_j=25^{\circ}\text{C}$ $11.5\text{V}\leq V_{in}\leq 24\text{V}$, $5\text{mA}\leq I_o\leq 1\text{A}$, $PD\leq 15\text{W}$	V
	B-rank(5%)		8.55	-	9.45		
ΔV_o	Line Regulation	-	5	90	$11.5\text{V}\leq V_{in}\leq 25\text{V}$, $T_j=25^{\circ}\text{C}$	mV	
		-	3	45	$13\text{V}\leq V_{in}\leq 19\text{V}$, $T_j=25^{\circ}\text{C}$		
ΔV_o	Load Regulation	-	-	100	$5\text{mA}\leq I_o\leq 1.5\text{A}$, $T_j=25^{\circ}\text{C}$	mV	
		-	-	50	$250\text{mA}\leq I_o\leq 750\text{mA}$, $T_j=25^{\circ}\text{C}$		
I_Q	Quiescent Current	-	-	8	$V_{in}=15\text{V}$, $I_o=500\text{mA}$, $T_j=25^{\circ}\text{C}$	mA	
ΔI_Q	Quiescent Current Change	-	-	0.5	$5\text{mA}\leq I_o\leq 1\text{A}$	mA	
		-	-	1.3	$11.5\text{V}\leq V_{in}\leq 26\text{V}$		
V_n	Output Noise Voltage	-	58	-	$10\text{Hz}\leq f\leq 100\text{KHz}$, $T_j=25^{\circ}\text{C}$	μV	
RR	Ripple Rejection	-	72	-	$12.5\text{V}\leq V_{in}\leq 22.5\text{V}$, $f=120\text{Hz}$, $T_j=25^{\circ}\text{C}$	dB	
VD	Dropout Voltage	-	2	-	$I_o=1\text{A}$, $T_j=25^{\circ}\text{C}$	V	
ISC	Output Short Circuit Current	-	250	-	$V_{in}=35\text{V}$, $T_j=25^{\circ}\text{C}$	mA	
IPK	Peak Output Current	-	1.8	-	$T_j=25^{\circ}\text{C}$	A	
$\Delta V_o/\Delta T_j$	Temperature Stability	-	-1.1	-	$I_o=5\text{mA}$, $0^{\circ}\text{C}\leq T_j\leq 125^{\circ}\text{C}$	$\text{mV}/^{\circ}\text{C}$	

LM7810 ($T_j=0\sim 125^{\circ}\text{C}$, $V_{in}=16\text{V}$, $I_o=500\text{mA}$, $C_{in}=0.33\mu\text{F}$, $C_{out}=0.1\mu\text{F}$, unless otherwise noted)

Symbol	Parameter	Min	Typ	Max	Conditions	Units	
V_o	A-rank(3%)	Output Voltage	9.70	10.0	10.30	$V_{in}=16\text{V}$, $I_o=500\text{mA}$, $T_j=25^{\circ}\text{C}$ $12.5\text{V}\leq V_{in}\leq 25\text{V}$, $5\text{mA}\leq I_o\leq 1\text{A}$, $PD\leq 15\text{W}$	V
	B-rank(5%)		9.50	-	10.50		
ΔV_o	Line Regulation	-	-	100	$13\text{V}\leq V_{in}\leq 25\text{V}$, $T_j=25^{\circ}\text{C}$	mV	
		-	-	50	$14\text{V}\leq V_{in}\leq 20\text{V}$, $T_j=25^{\circ}\text{C}$		
ΔV_o	Load Regulation	-	-	100	$5\text{mA}\leq I_o\leq 1.5\text{A}$, $T_j=25^{\circ}\text{C}$	mV	
		-	-	50	$250\text{mA}\leq I_o\leq 750\text{mA}$, $T_j=25^{\circ}\text{C}$		
I_Q	Quiescent Current	-	-	8	$V_{in}=16\text{V}$, $I_o=500\text{mA}$, $T_j=25^{\circ}\text{C}$	mA	
ΔI_Q	Quiescent Current Change	-	-	0.5	$5\text{mA}\leq I_o\leq 1\text{A}$	mA	
		-	-	1.0	$12.5\text{V}\leq V_{in}\leq 25\text{V}$		
V_n	Output Noise Voltage	-	58	-	$10\text{Hz}\leq f\leq 100\text{KHz}$, $T_j=25^{\circ}\text{C}$	μV	
RR	Ripple Rejection	-	72	-	$13\text{V}\leq V_{in}\leq 23\text{V}$, $f=120\text{Hz}$, $T_j=25^{\circ}\text{C}$	dB	
VD	Dropout Voltage	-	2	-	$I_o=1\text{A}$, $T_j=25^{\circ}\text{C}$	V	
ISC	Output Short Circuit Current	-	250	-	$V_{in}=35\text{V}$, $T_j=25^{\circ}\text{C}$	mA	
IPK	Peak Output Current	-	1.8	-	$T_j=25^{\circ}\text{C}$	A	
$\Delta V_o/\Delta T_j$	Temperature Stability	-	-1.1	-	$I_o=5\text{mA}$, $0^{\circ}\text{C}\leq T_j\leq 125^{\circ}\text{C}$	$\text{mV}/^{\circ}\text{C}$	



LM7812 ($T_j=0\sim 125^{\circ}\text{C}$, $V_{in}=19\text{V}$, $I_o=500\text{mA}$, $C_{in}=0.33\mu\text{F}$, $C_{out}=0.1\mu\text{F}$, unless otherwise noted)

Symbol	Parameter	Min	Typ	Max	Conditions	Units	
V_o	A-rank(3%)	Output Voltage	11.64	12.0	12.36	$V_{in}=19\text{V}$, $I_o=500\text{mA}$, $T_j=25^{\circ}\text{C}$ $14.5\text{V}\leq V_{in}\leq 27\text{V}$, $5\text{mA}\leq I_o\leq 1\text{A}$, $PD\leq 15\text{W}$	V
	B-rank(5%)		11.40	-	12.60		
ΔV_o	Line Regulation	-	10	120	$14.5\text{V}\leq V_{in}\leq 30\text{V}$, $T_j=25^{\circ}\text{C}$	mV	
		-	3	60	$16\text{V}\leq V_{in}\leq 22\text{V}$, $T_j=25^{\circ}\text{C}$		
ΔV_o	Load Regulation	-	-	100	$5\text{mA}\leq I_o\leq 1.5\text{A}$, $T_j=25^{\circ}\text{C}$	mV	
		-	-	60	$250\text{mA}\leq I_o\leq 750\text{mA}$, $T_j=25^{\circ}\text{C}$		
I_Q	Quiescent Current	-	-	8	$V_{in}=19\text{V}$, $I_o=500\text{mA}$, $T_j=25^{\circ}\text{C}$	mA	
ΔI_Q	Quiescent Current Change	-	-	0.5	$5\text{mA}\leq I_o\leq 1\text{A}$	mA	
		-	-	1.3	$14.5\text{V}\leq V_{in}\leq 30\text{V}$		
V_n	Output Noise Voltage	-	75	-	$10\text{Hz}\leq f\leq 100\text{KHz}$, $T_j=25^{\circ}\text{C}$	μV	
RR	Ripple Rejection	-	72	-	$15\text{V}\leq V_{in}\leq 25\text{V}$, $f=120\text{Hz}$, $T_j=25^{\circ}\text{C}$	dB	
VD	Dropout Voltage	-	2	-	$I_o=1\text{A}$, $T_j=25^{\circ}\text{C}$	V	
ISC	Output Short Circuit Current	-	250	-	$V_{in}=35\text{V}$, $T_j=25^{\circ}\text{C}$	mA	
IPK	Peak Output Current	-	1.8	-	$T_j=25^{\circ}\text{C}$	A	
$\Delta V_o/\Delta T_j$	Temperature Stability	-	-1.5	-	$I_o=5\text{mA}$, $0^{\circ}\text{C}\leq T_j\leq 125^{\circ}\text{C}$	$\text{mV}/^{\circ}\text{C}$	

LM7815 ($T_j=0\sim 125^{\circ}\text{C}$, $V_{in}=23\text{V}$, $I_o=500\text{mA}$, $C_{in}=0.33\mu\text{F}$, $C_{out}=0.1\mu\text{F}$, unless otherwise noted)

Symbol	Parameter	Min	Typ	Max	Conditions	Units	
V_o	A-rank(3%)	Output Voltage	14.55	15.0	15.45	$V_{in}=23\text{V}$, $I_o=500\text{mA}$, $T_j=25^{\circ}\text{C}$ $17.5\text{V}\leq V_{in}\leq 30\text{V}$, $5\text{mA}\leq I_o\leq 1\text{A}$, $PD\leq 15\text{W}$	V
	B-rank(5%)		14.25	-	15.75		
ΔV_o	Line Regulation	-	-	150	$17.5\text{V}\leq V_{in}\leq 30\text{V}$, $T_j=25^{\circ}\text{C}$	mV	
		-	-	75	$18.5\text{V}\leq V_{in}\leq 30\text{V}$, $T_j=25^{\circ}\text{C}$		
ΔV_o	Load Regulation	-	-	150	$5\text{mA}\leq I_o\leq 1.5\text{A}$, $T_j=25^{\circ}\text{C}$	mV	
		-	-	75	$250\text{mA}\leq I_o\leq 750\text{mA}$, $T_j=25^{\circ}\text{C}$		
I_Q	Quiescent Current	-	-	8	$V_{in}=23\text{V}$, $I_o=500\text{mA}$, $T_j=25^{\circ}\text{C}$	mA	
ΔI_Q	Quiescent Current Change	-	-	0.5	$5\text{mA}\leq I_o\leq 1\text{A}$	mA	
		-	-	1.3	$17.5\text{V}\leq V_{in}\leq 30\text{V}$		
V_n	Output Noise Voltage	-	90	-	$10\text{Hz}\leq f\leq 100\text{KHz}$, $T_j=25^{\circ}\text{C}$	μV	
RR	Ripple Rejection	-	70	-	$18.5\text{V}\leq V_{in}\leq 28.5\text{V}$, $f=120\text{Hz}$, $T_j=25^{\circ}\text{C}$	dB	
VD	Dropout Voltage	-	2	-	$I_o=1\text{A}$, $T_j=25^{\circ}\text{C}$	V	
ISC	Output Short Circuit Current	-	250	-	$V_{in}=35\text{V}$, $T_j=25^{\circ}\text{C}$	mA	
IPK	Peak Output Current	-	1.8	-	$T_j=25^{\circ}\text{C}$	A	
$\Delta V_o/\Delta T_j$	Temperature Stability	-	-1.8	-	$I_o=5\text{mA}$, $0^{\circ}\text{C}\leq T_j\leq 125^{\circ}\text{C}$	$\text{mV}/^{\circ}\text{C}$	



LM7818 ($T_j=0\sim 125^{\circ}\text{C}$, $V_{in}=27\text{V}$, $I_o=500\text{mA}$, $C_{in}=0.33\mu\text{F}$, $C_{out}=0.1\mu\text{F}$, unless otherwise noted)

Symbol	Parameter	Min	Typ	Max	Conditions	Units	
V_o	A-rank(3%)	Output Voltage	17.46	18.0	18.54	$V_{in}=27\text{V}$, $I_o=500\text{mA}$, $T_j=25^{\circ}\text{C}$ $21\text{V}\leq V_{in}\leq 33\text{V}$, $5\text{mA}\leq I_o\leq 1\text{A}$, $PD\leq 15\text{W}$	V
	B-rank(5%)		17.10	-	18.90		
ΔV_o	Line Regulation	-	-	180	$21\text{V}\leq V_{in}\leq 33\text{V}$, $T_j=25^{\circ}\text{C}$	mV	
		-	-	90	$24\text{V}\leq V_{in}\leq 30\text{V}$, $T_j=25^{\circ}\text{C}$		
ΔV_o	Load Regulation	-	-	180	$5\text{mA}\leq I_o\leq 1.5\text{A}$, $T_j=25^{\circ}\text{C}$	mV	
		-	-	90	$250\text{mA}\leq I_o\leq 750\text{mA}$, $T_j=25^{\circ}\text{C}$		
I_Q	Quiescent Current	-	-	8	$V_{in}=27\text{V}$, $I_o=500\text{mA}$, $T_j=25^{\circ}\text{C}$	mA	
ΔI_Q	Quiescent Current Change	-	-	0.5	$5\text{mA}\leq I_o\leq 1\text{A}$	mA	
		-	-	1.0	$21\text{V}\leq V_{in}\leq 33\text{V}$		
V_n	Output Noise Voltage	-	110	-	$10\text{Hz}\leq f\leq 100\text{KHz}$, $T_j=25^{\circ}\text{C}$	μV	
RR	Ripple Rejection	-	69	-	$22\text{V}\leq V_{in}\leq 32\text{V}$, $f=120\text{Hz}$, $T_j=25^{\circ}\text{C}$	dB	
VD	Dropout Voltage	-	2	-	$I_o=1\text{A}$, $T_j=25^{\circ}\text{C}$	V	
ISC	Output Short Circuit Current	-	250	-	$V_{in}=35\text{V}$, $T_j=25^{\circ}\text{C}$	mA	
IPK	Peak Output Current	-	1.8	-	$T_j=25^{\circ}\text{C}$	A	
$\Delta V_o/\Delta T_j$	Temperature Stability	-	-2.2	-	$I_o=5\text{mA}$, $0^{\circ}\text{C}\leq T_j\leq 125^{\circ}\text{C}$	$\text{mV}/^{\circ}\text{C}$	

LM7824 ($T_j=0\sim 125^{\circ}\text{C}$, $V_{in}=33\text{V}$, $I_o=500\text{mA}$, $C_{in}=0.33\mu\text{F}$, $C_{out}=0.1\mu\text{F}$, unless otherwise noted)

Symbol	Parameter	Min	Typ	Max	Conditions	Units	
V_o	A-rank(3%)	Output Voltage	23.28	24.0	24.72	$V_{in}=33\text{V}$, $I_o=500\text{mA}$, $T_j=25^{\circ}\text{C}$ $27\text{V}\leq V_{in}\leq 38\text{V}$, $5\text{mA}\leq I_o\leq 1\text{A}$, $PD\leq 15\text{W}$	V
	B-rank(5%)		22.80	-	25.20		
ΔV_o	Line Regulation	-	-	240	$27\text{V}\leq V_{in}\leq 38\text{V}$, $T_j=25^{\circ}\text{C}$	mV	
		-	-	120	$30\text{V}\leq V_{in}\leq 36\text{V}$, $T_j=25^{\circ}\text{C}$		
ΔV_o	Load Regulation	-	-	240	$5\text{mA}\leq I_o\leq 1.5\text{A}$, $T_j=25^{\circ}\text{C}$	mV	
		-	-	120	$250\text{mA}\leq I_o\leq 750\text{mA}$, $T_j=25^{\circ}\text{C}$		
I_Q	Quiescent Current	-	-	8	$V_{in}=33\text{V}$, $I_o=500\text{mA}$, $T_j=25^{\circ}\text{C}$	mA	
ΔI_Q	Quiescent Current Change	-	-	0.5	$5\text{mA}\leq I_o\leq 1\text{A}$	mA	
		-	-	1.0	$28\text{V}\leq V_{in}\leq 38\text{V}$		
V_n	Output Noise Voltage	-	170	-	$10\text{Hz}\leq f\leq 100\text{KHz}$, $T_j=25^{\circ}\text{C}$	μV	
RR	Ripple Rejection	-	66	-	$28\text{V}\leq V_{in}\leq 38\text{V}$, $f=120\text{Hz}$, $T_j=25^{\circ}\text{C}$	dB	
VD	Dropout Voltage	-	2	-	$I_o=1\text{A}$, $T_j=25^{\circ}\text{C}$	V	
ISC	Output Short Circuit Current	-	250	-	$V_{in}=35\text{V}$, $T_j=25^{\circ}\text{C}$	mA	
IPK	Peak Output Current	-	1.8	-	$T_j=25^{\circ}\text{C}$	A	
$\Delta V_o/\Delta T_j$	Temperature Stability	-	-2.8	-	$I_o=5\text{mA}$, $0^{\circ}\text{C}\leq T_j\leq 125^{\circ}\text{C}$	$\text{mV}/^{\circ}\text{C}$	

Characteristic Curves

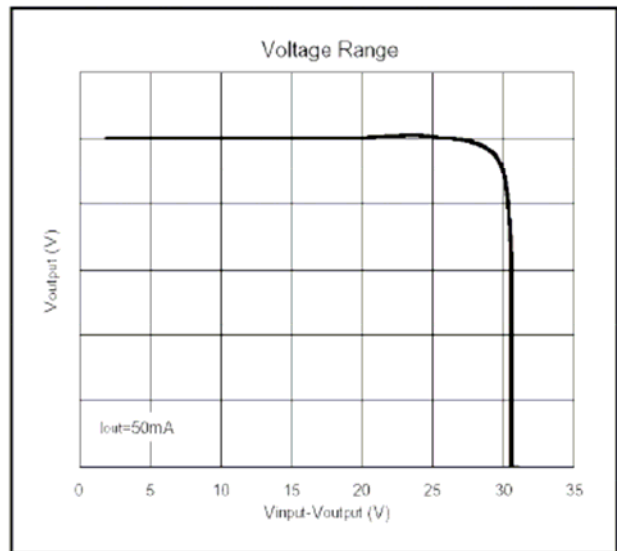
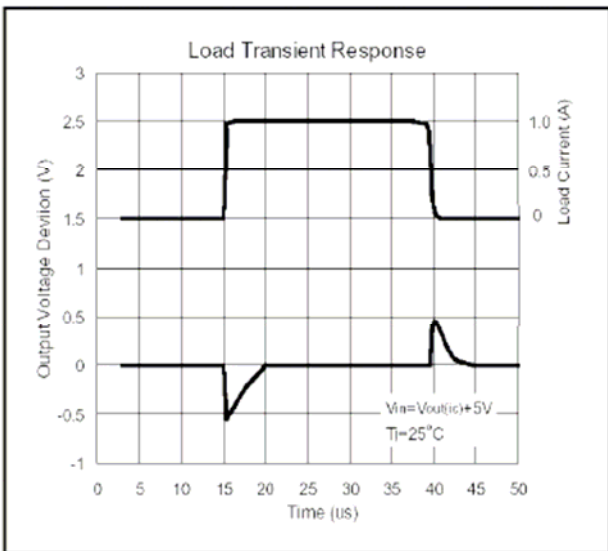
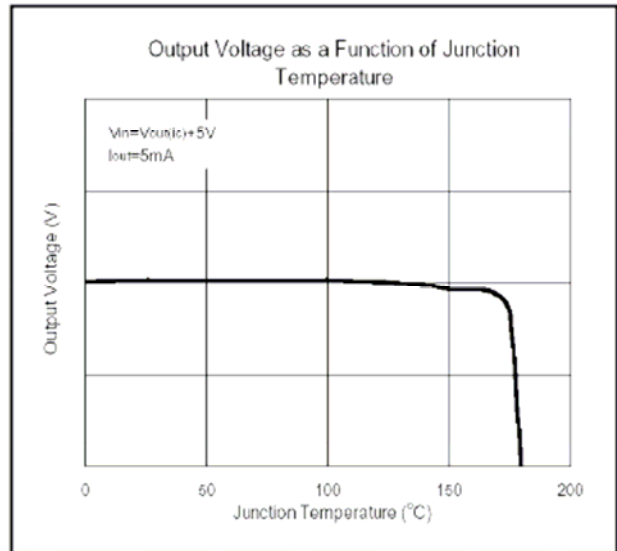
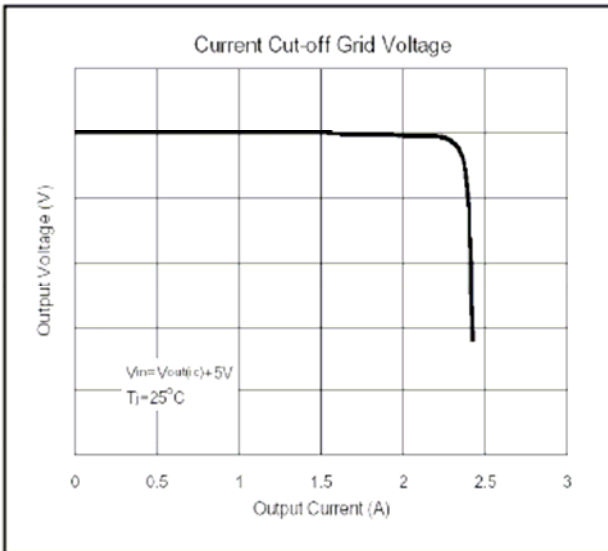

Recommended wave soldering condition

Product	Peak Temperature	Soldering Time
Pb-free devices	260 +0/-5 °C	5 +1/-1 seconds

Recommended temperature profile for IR reflow

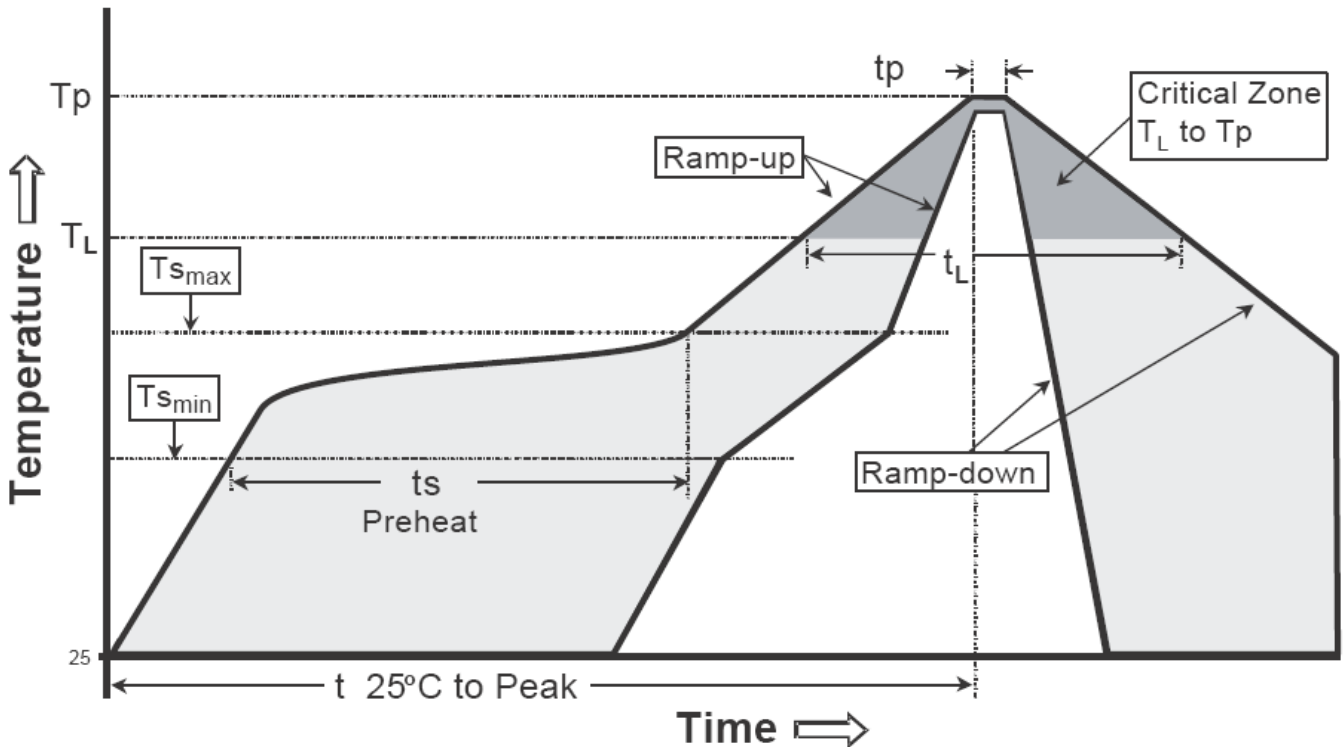

Profile feature	Sn-Pb eutectic Assembly	Pb-free Assembly
Average ramp-up rate (T _{smax} to T _p)	3°C/second max.	3°C/second max.
Preheat		
-Temperature Min(T _{s min})	100°C	150°C
-Temperature Max(T _{s max})	150°C	200°C
-Time(t _{s min} to t _{s max})	60-120 seconds	60-180 seconds
Time maintained above:		
-Temperature (T _L)	183°C	217°C
- Time (t _L)	60-150 seconds	60-150 seconds
Peak Temperature(T _P)	240 +0/-5 °C	260 +0/-5 °C
Time within 5°C of actual peak temperature(tp)	10-30 seconds	20-40 seconds
Ramp down rate	6°C/second max.	6°C/second max.
Time 25 °C to peak temperature	6 minutes max.	8 minutes max.

Note : All temperatures refer to topside of the package, measured on the package body surface.

TO-220 Dimension

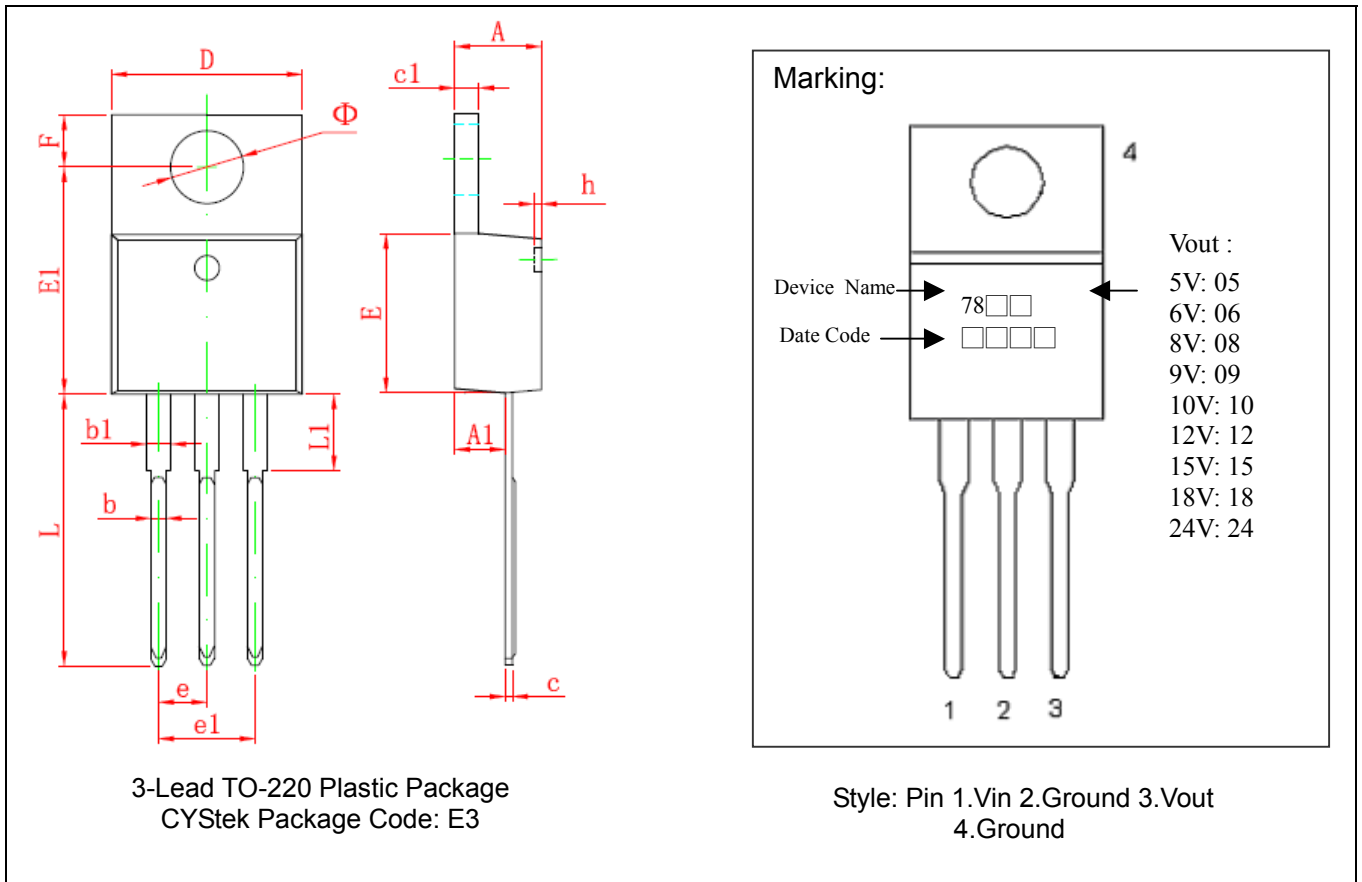

The diagram shows two views of a TO-220 package: a top view and a side view. The top view labels dimensions D (width), F (hole diameter), E1 (height to lead start), b1 (lead width), b (lead thickness), e (lead pitch), and e1 (lead width at base). The side view labels dimensions A (total height), c1 (height to lead start), h (lead thickness), E (height to lead base), A1 (lead length), and c (lead thickness at base).

Marking:

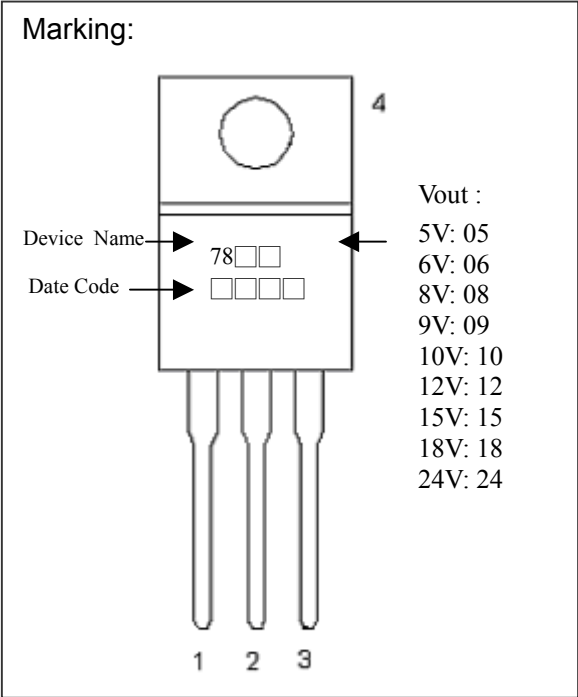

Device Name → 78□□
 Date Code → □□□□

Vout :
 5V: 05
 6V: 06
 8V: 08
 9V: 09
 10V: 10
 12V: 12
 15V: 15
 18V: 18
 24V: 24

3-Lead TO-220 Plastic Package
 CYStek Package Code: E3

Style: Pin 1.Vin 2.Ground 3.Vout
 4.Ground

*: Typical

DIM	Millimeters		Inches		DIM	Millimeters		Inches	
	Min.	Max.	Min.	Max.		Min.	Max.	Min.	Max.
A	4.470	4.670	0.176	0.184	E1	12.060	12.460	0.475	0.491
A1	2.520	2.820	0.099	0.111	e	2.540*		0.100*	
b	0.710	0.910	0.028	0.036	e1	4.980	5.180	0.196	0.204
b1	1.170	1.370	0.046	0.054	F	2.590	2.890	0.102	0.114
c	0.310	0.530	0.012	0.021	h	0.000	0.300	0.000	0.012
c1	1.170	1.370	0.046	0.054	L	13.400	13.800	0.528	0.543
D	10.010	10.310	0.394	0.406	L1	3.560	3.960	0.140	0.156
E	8.500	8.900	0.335	0.350	Φ	3.735	3.935	0.147	0.155

Notes: 1.Controlling dimension: millimeters.
 2.Maximum lead thickness includes lead finish thickness, and minimum lead thickness is the minimum thickness of base material.
 3.If there is any question with packing specification or packing method, please contact your local CYStek sales office.

Material:

- Lead: Pure tin plated.
- Mold Compound: Epoxy resin family, flammability solid burning class: UL94V-0.

Important Notice:

- All rights are reserved. Reproduction in whole or in part is prohibited without the prior written approval of CYStek.
- CYStek reserves the right to make changes to its products without notice.
- CYStek **semiconductor products are not warranted to be suitable for use in Life-Support Applications, or systems.**
- CYStek assumes no liability for any consequence of customer product design, infringement of patents, or application assistance.