

Dual Operational Comparator

LM358Q8

Description

The LM358Q8 consists of two independent high gain, internally frequency compensated operational amplifier. It can be operated from a single power supply and also split power supplies.

Features

- Internally frequency compensated for unity gain
- Single supply operation:3V to 32V
- Input common-mode voltage range includes ground
- Large DC voltage gain

Applications

- General purpose amplifier
- Transducer amplifier

Pin Configurations

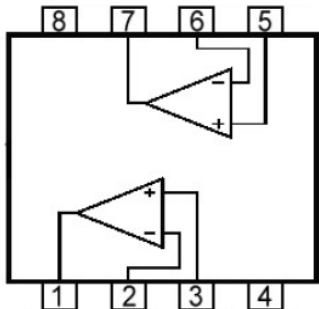
	Pin1: OUTPUT 1	Pin5: INPUT 2 (+)
	Pin2: INPUT 1 (-)	Pin6: INPUT 2 (-)
	Pin3: INPUT 1 (+)	Pin7: OUTPUT 2
	Pin4: Gnd/VEE	Pin8: VCC

Ordering Information

Device	Package	Shipping
LM358Q8-0-T3-G	SOP-8 (Pb-free lead plating and halogen-free package)	2500 pcs / tape & reel
LM358Q8-0-TF-G	SOP-8 (Pb-free lead plating and halogen-free package)	4000 pcs / tape & reel

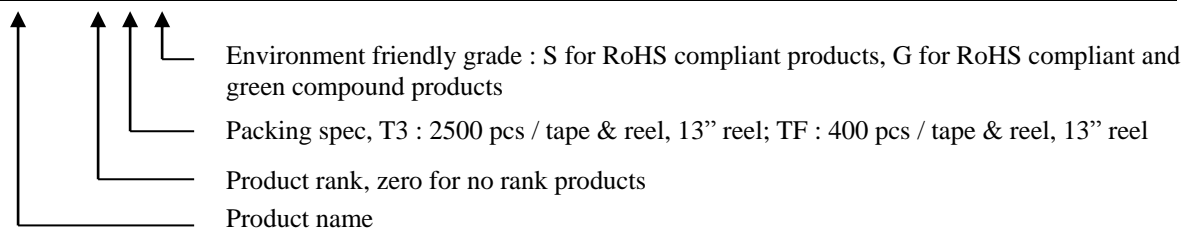



Absolute Maximum Rating(Ta=25°C)

Parameter	Symbol	Value	Unit
Power Supply Voltages			
Single Supply	V _{CC}	32	V
Split Supplies	V _{CC} , V _{EE}	±16	
Input Differential Voltage Range	V _{IDR}	±32	V
Input Common Mode Voltage Range	V _{ICR}	-0.3 ~ +32	V
Output Short Circuit Duration	t _{SC}	Continuous	
Operating Temperature	T _{opr}	0 ~ +70	°C
Storage Temperature	T _{stg}	-65 ~ +150	°C

Electrical Characteristics (V_{CC}=5V, Ta=25°C, V_{EE}=GND, unless otherwise specified.)

Parameter	Test Condition	Symbol	Min.	Typ.	Max.	Unit
Input Offset Voltage	V _{CM} =0 to V _{CC} -1.5V V _{O(p)} =1.4V, R _S =0	V _{IO}	-	2.9	7.0	mV
Input Offset Current		I _{IO}	-	5	50	nA
Input Bias Current		I _{IB}	-	45	250	nA
Input Common-Mode Voltage	V _{CC} =30V	V _{ICR}	0	-	V _{CC} -1.5	V
Power Supply Current	R _L =∞, V _{CC} =5V, V _O =0V	I _{CC}	-	0.5	1.2	mA
	R _L =∞, V _{CC} =30V, V _O =0V		-	0.8	2.0	mA
Large Signal Voltage Gain	V _{CC} =15V, R _L ≥2kΩ V _{O(p)} =1V to 11V	G _V	25	100	-	V/mV
Output Voltage-High Limit	V _{CC} =30V, R _L =2kΩ	V _{O(H)}	26	-	-	V
	V _{CC} =30V, R _L =10kΩ		27	28	-	
Output Voltage-Low Limit	V _{CC} =5V, R _L ≥10kΩ	V _{O(L)}	-	5	20	mV
Common Mode Rejection Ratio		CMRR	65	80	-	dB
Power Supply Rejection Ratio		PSRR	65	100	-	dB
Channel Separation	f=1kHz to 20kHz	CS	-	120	-	dB
Short Circuit Current to Ground		I _{SC}	-	40	60	mA
Output Source Current	V _{i(+)} =1V, V _{i(-)} =0V, V _{CC} =15V, V _{O(p)} =2V	I _{source}	10	30	-	mA
Output Sink Current	V _{i(+)} =0V, V _{i(-)} =1V, V _{CC} =15V, V _{O(p)} =2V	I _{sink}	10	15	-	mA
	V _{i(+)} =0V, V _{i(-)} =1V, V _{CC} =15V, V _{O(p)} =0.2V		12	100	-	μA
Differential Input Voltage		V _{IDR}	-	-	V _{CC}	V

Block Diagram

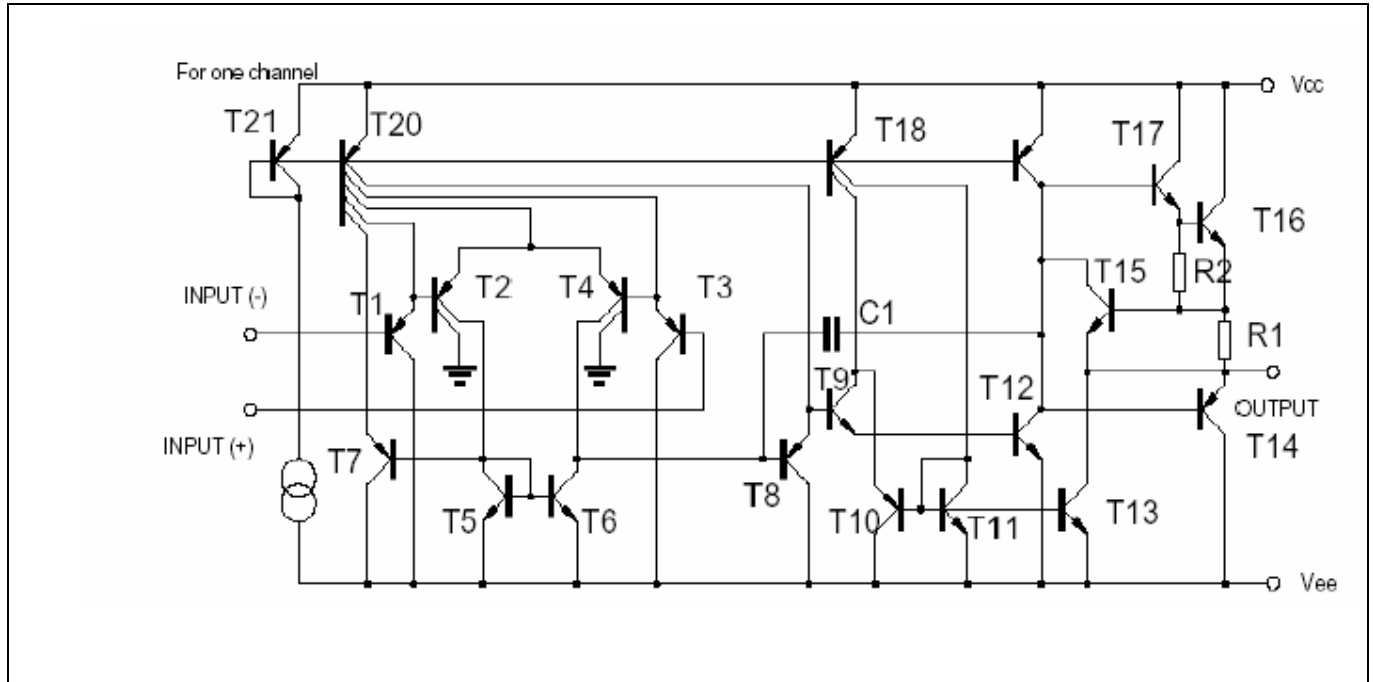

Typical Characteristics

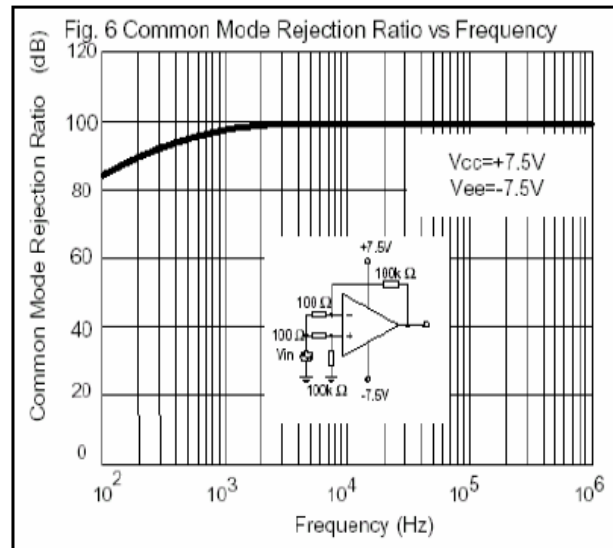
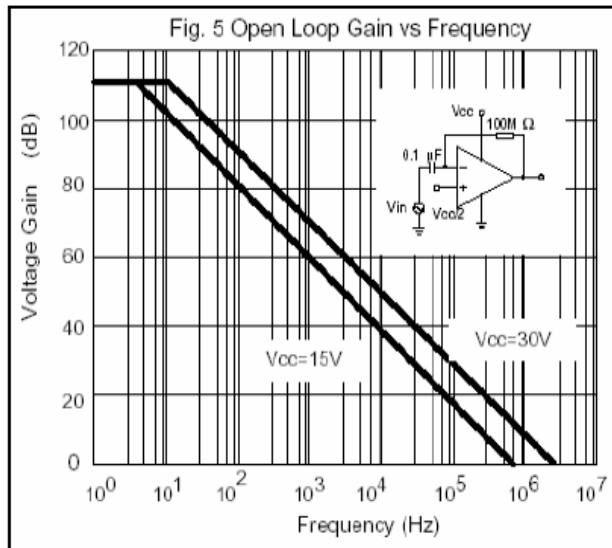
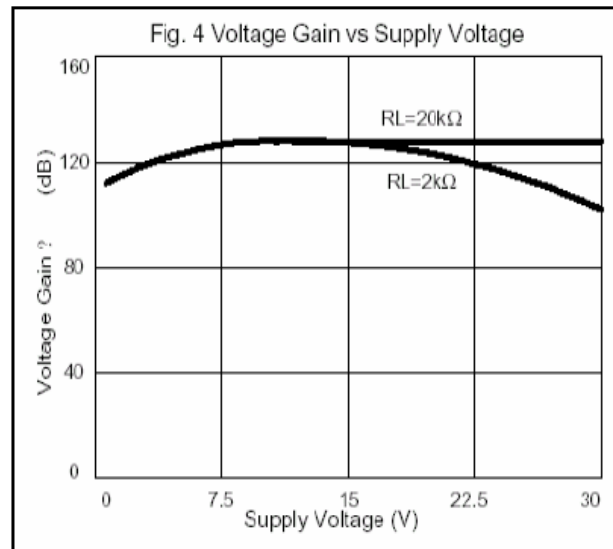
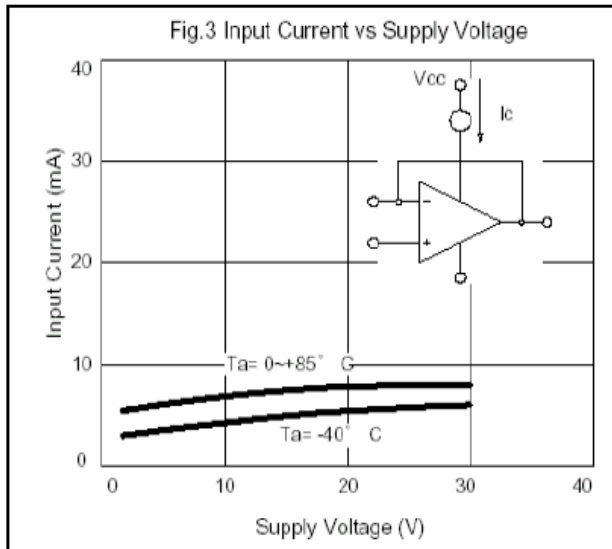
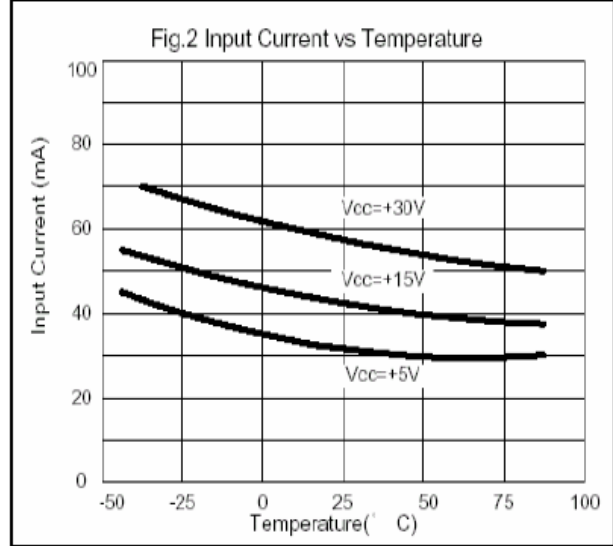
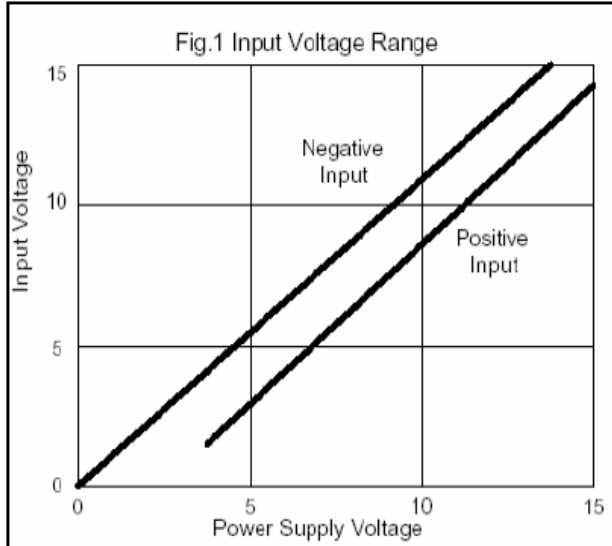

Typical Characteristics(Cont.)

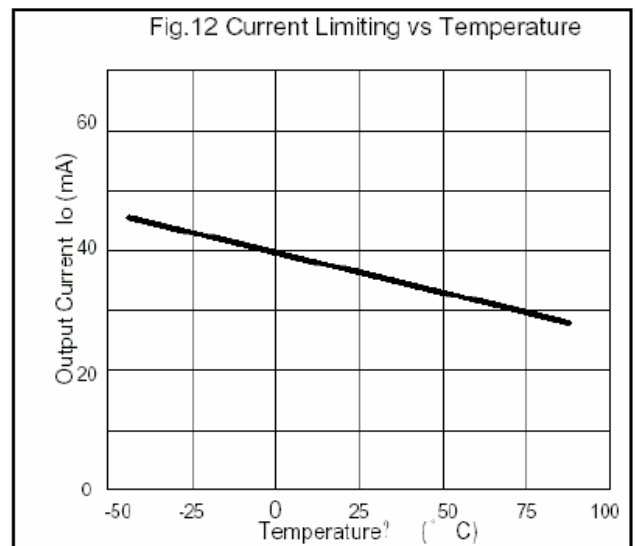
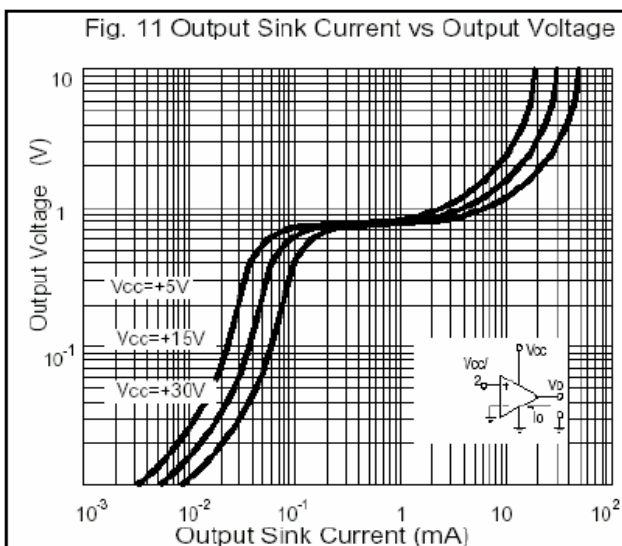
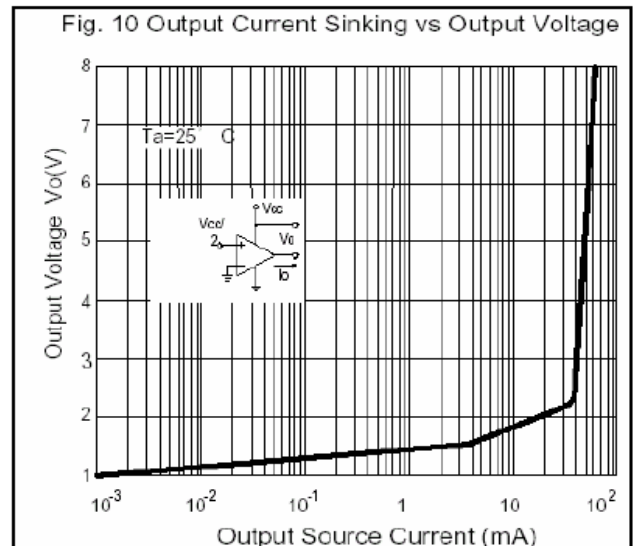
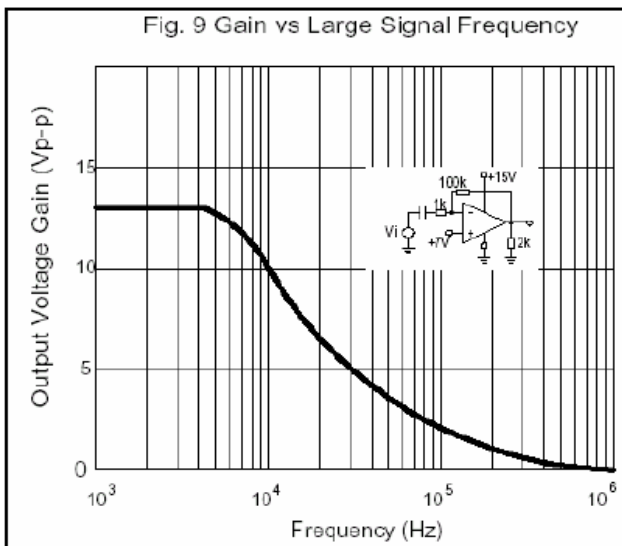
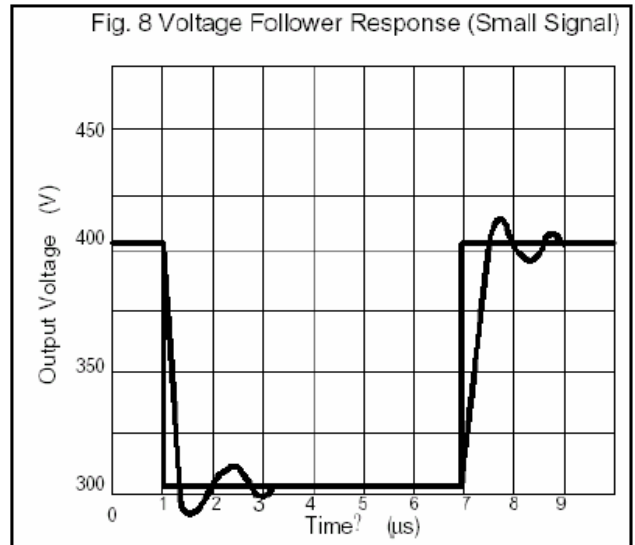
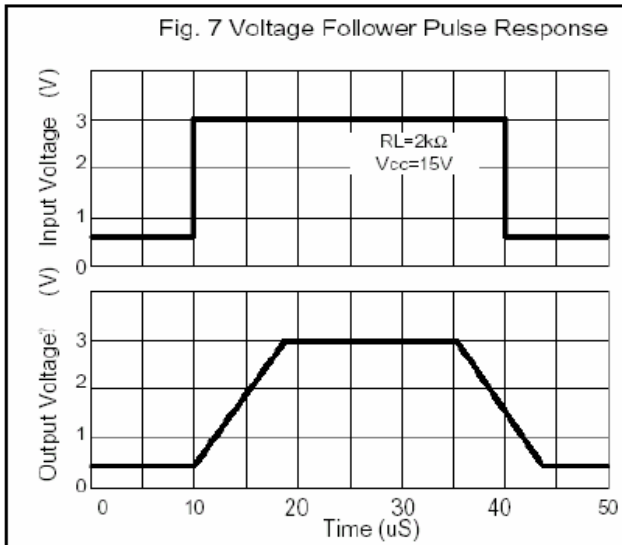

Reel Dimension

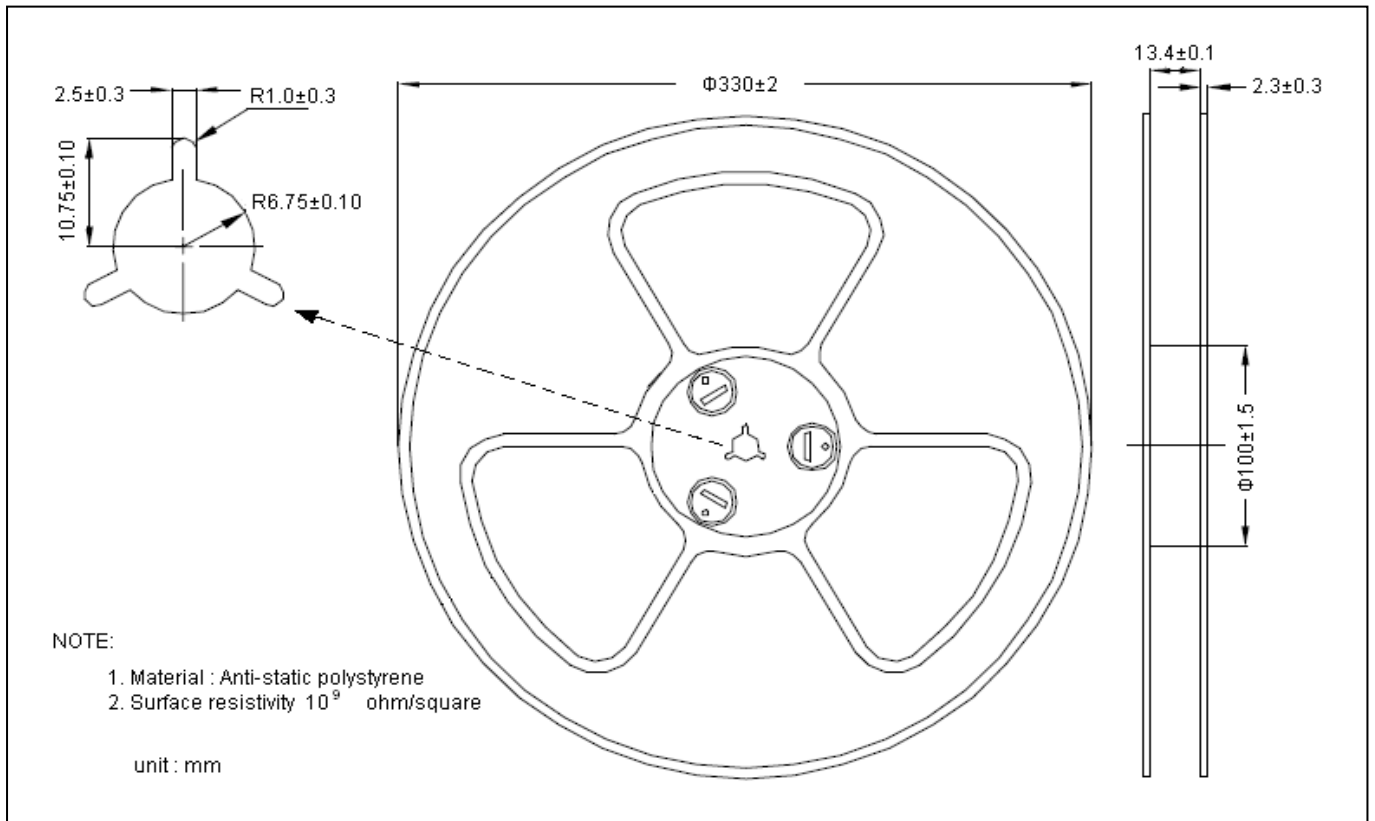

Carrier Tape Dimension

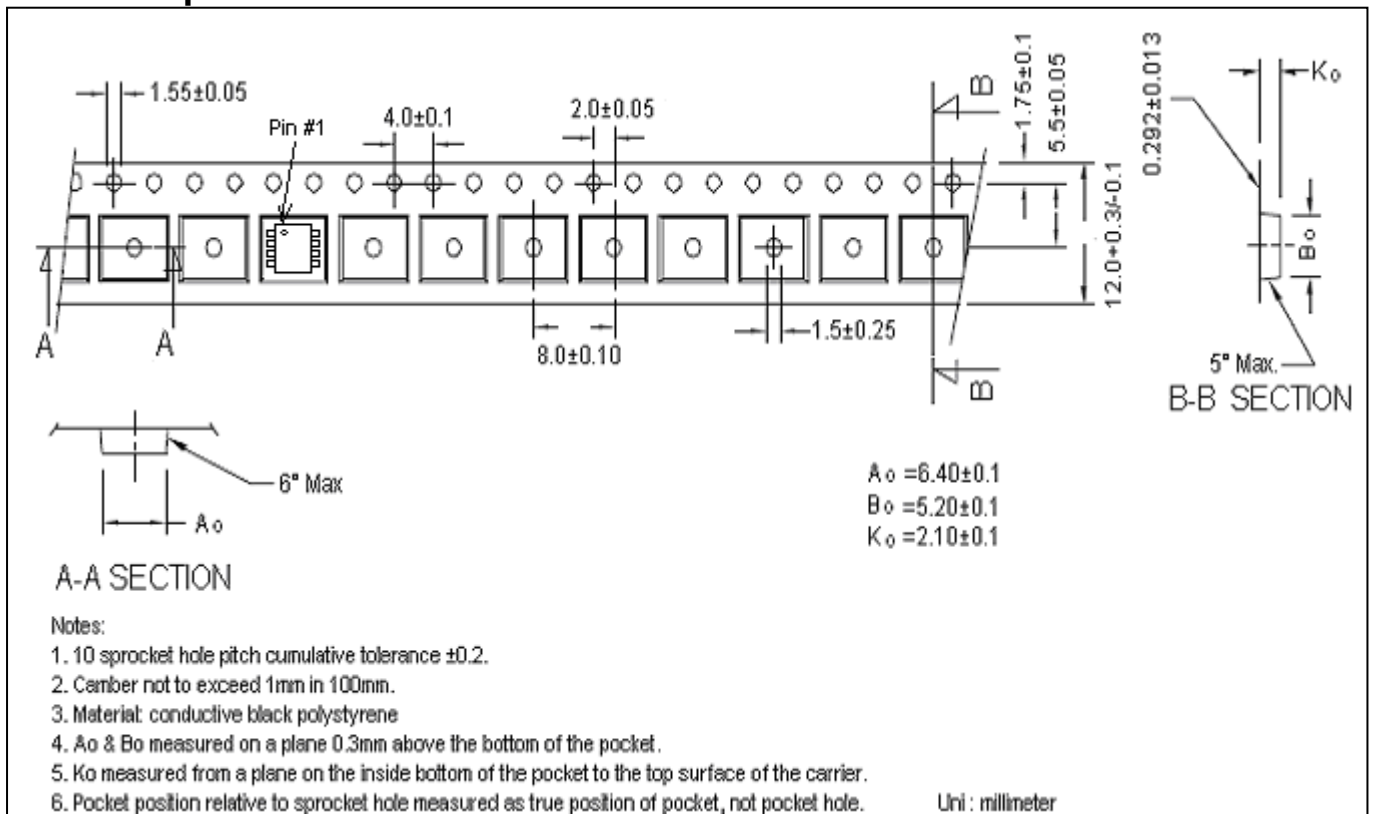

Recommended wave soldering condition

Product	Peak Temperature	Soldering Time
Pb-free devices	260 +0/-5 °C	5 +1/-1 seconds

Recommended temperature profile for IR reflow

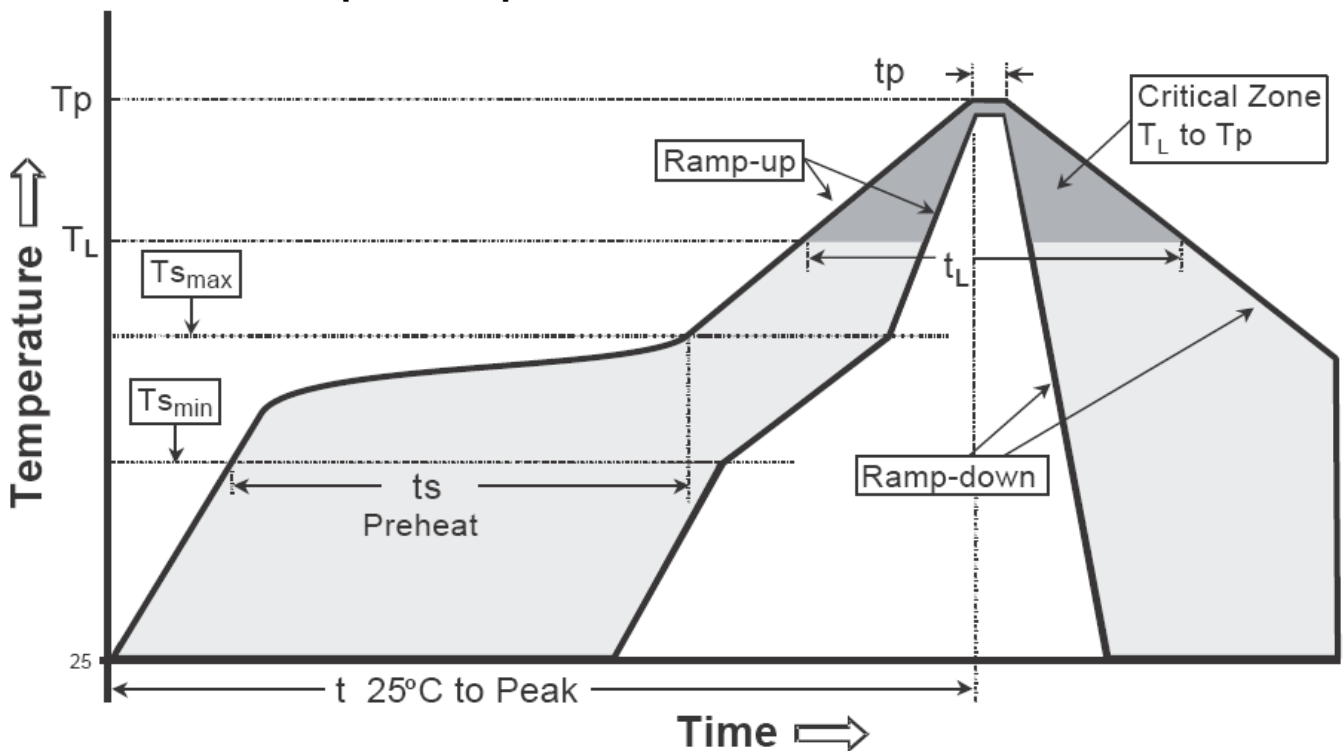

Profile feature	Sn-Pb eutectic Assembly	Pb-free Assembly
Average ramp-up rate (Tsmax to Tp)	3°C/second max.	3°C/second max.
Preheat		
-Temperature Min(Ts min)	100°C	150°C
-Temperature Max(Ts max)	150°C	200°C
-Time(ts min to ts max)	60-120 seconds	60-180 seconds
Time maintained above:		
-Temperature (Tl)	183°C	217°C
- Time (tL)	60-150 seconds	60-150 seconds
Peak Temperature(TP)	240 +0/-5 °C	260 +0/-5 °C
Time within 5°C of actual peak temperature(tp)	10-30 seconds	20-40 seconds
Ramp down rate	6°C/second max.	6°C/second max.
Time 25 °C to peak temperature	6 minutes max.	8 minutes max.

Note : All temperatures refer to topside of the package, measured on the package body surface.

SOP-8 Dimension

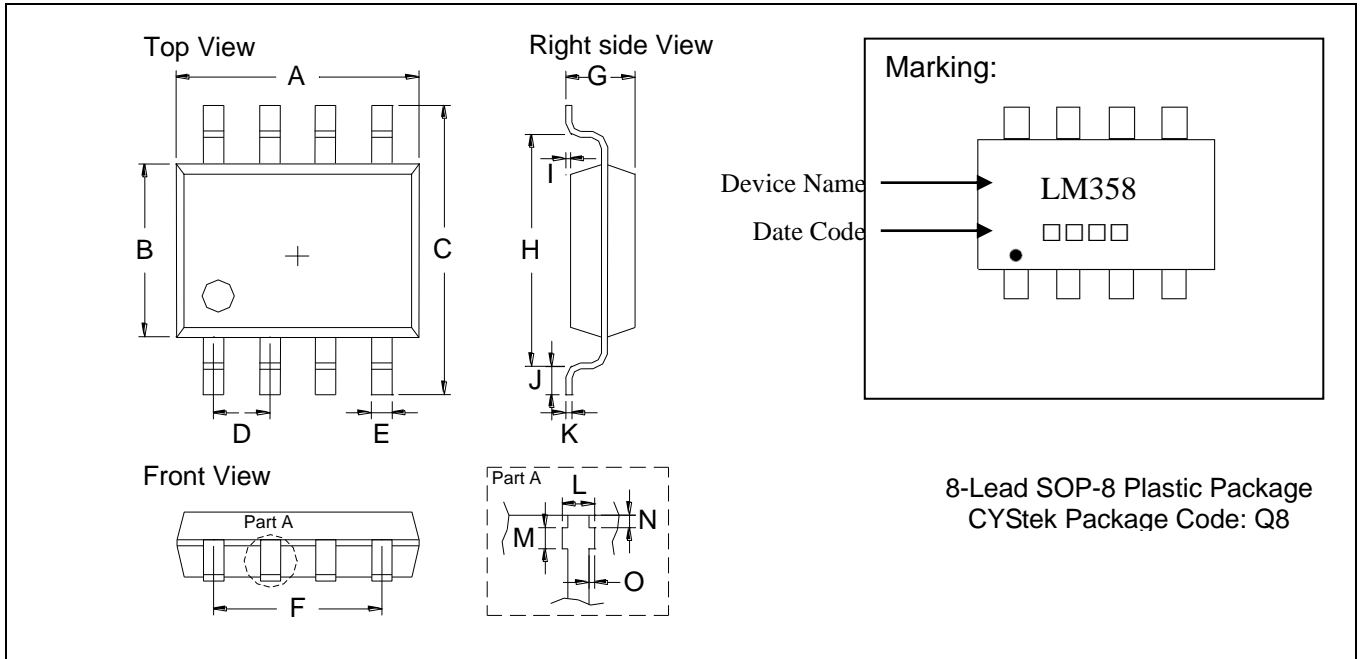

*: Typical

DIM	Inches		Millimeters		DIM	Inches		Millimeters	
	Min.	Max.	Min.	Max.		Min.	Max.	Min.	Max.
A	0.1909	0.2007	4.85	5.10	I	0.0019	0.0078	0.05	0.20
B	0.1515	0.1555	3.85	3.95	J	0.0118	0.0275	0.30	0.70
C	0.2283	0.2441	5.80	6.20	K	0.0074	0.0098	0.19	0.25
D	0.0480	0.0519	1.22	1.32	L	0.0145	0.0204	0.37	0.52
E	0.0145	0.0185	0.37	0.47	M	0.0118	0.0197	0.30	0.50
F	0.1472	0.1527	3.74	3.88	N	0.0031	0.0051	0.08	0.13
G	0.0570	0.0649	1.45	1.65	O	0.0000	0.0059	0.00	0.15
H	0.1889	0.2007	4.80	5.10					

Notes: 1.Controlling dimension: millimeters.
 2.Maximum lead thickness includes lead finish thickness, and minimum lead thickness is the minimum thickness of base material.
 3.If there is any question with packing specification or packing method, please contact your local CYStek sales office.

Material:

- Lead: 42 Alloy; solder plating
- Mold Compound: Epoxy resin family, flammability solid burning class: UL94V-0

Important Notice:

- All rights are reserved. Reproduction in whole or in part is prohibited without the prior written approval of CYStek.
- CYStek reserves the right to make changes to its products without notice.
- CYStek **semiconductor products are not warranted to be suitable for use in Life-Support Applications, or systems.**
- CYStek assumes no liability for any consequence of customer product design, infringement of patents, or application assistance.