

0.7A Low Dropout Positive Voltage Regulator

LM1117N3 series

Features

- Adjustable or Fixed Output
- Output Current of 0.7A
- Low Dropout, 1.4V max at 0.5A Output Current
- Good Noise Rejection
- Output Current Limiting
- Built-in Thermal Shutdown
- Fast Transient Response
- Pb-free lead plating package
- Can operate using MLCCs in the capacitance range of 2μF to 10μF

Description

The LM1117 series of positive adjustable and fixed regulators are designed to provide 0.7A with high efficiency. All internal circuitry is designed to operate down to 1.4V input to output differential. The product is specifically designed to provide well-regulated supply for low-voltage IC application such as high-speed bus termination and low current 3.3V logic supply, and other applications such as VGA cards.

Applications

- High Efficiency Linear Regulators
- Post Regulators for Switching Supplies
- Adjustable Power Supply

Typical Application Data

Fixed Voltage Regulator

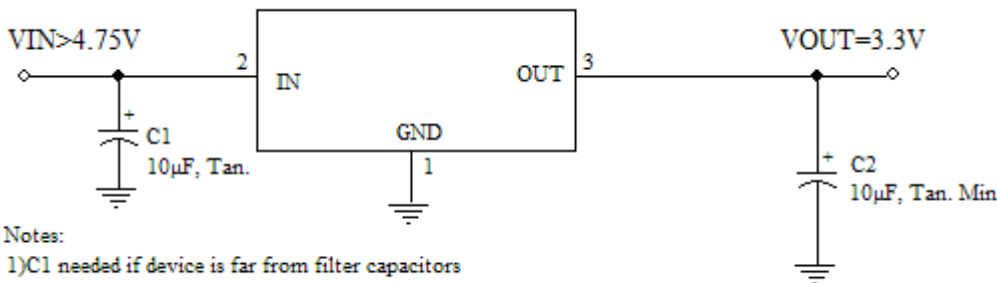

Adjustable Voltage Regulator

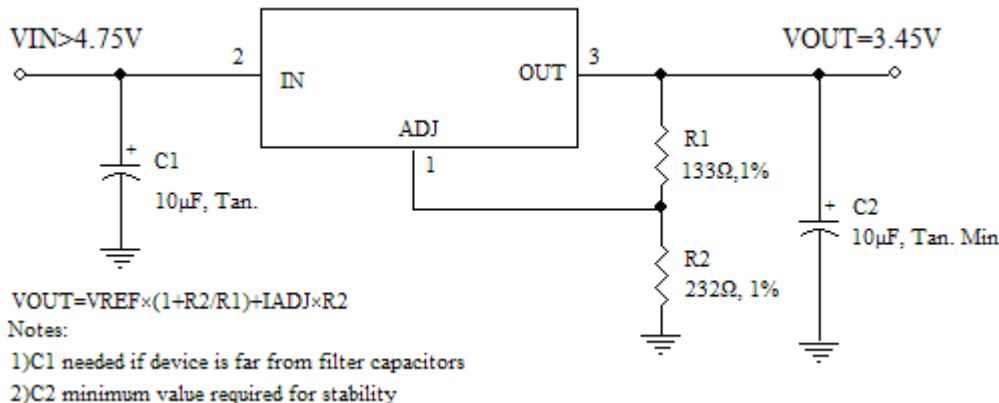

Package Information

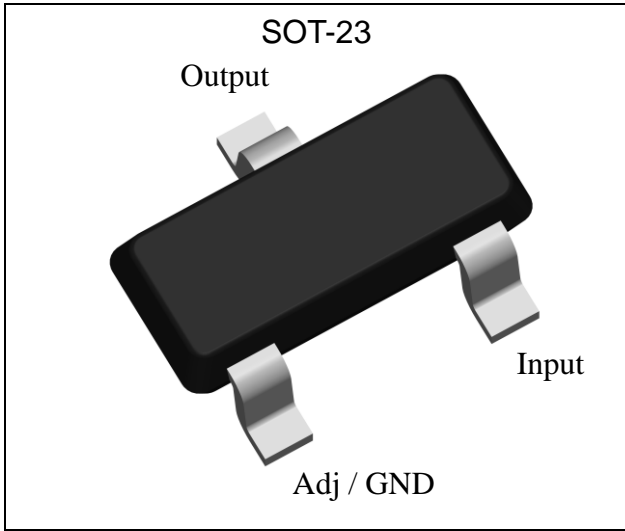

Absolute Maximum Ratings($T_A=25^{\circ}C$)

Symbol	Parameter	Maximum	Units
P_D	Power Dissipation	1 (Note)	W
V_{IN}	Input Voltage	20	V
$R_{\theta JA}$	Thermal resistance, Junction to Ambient	100 (Note)	$^{\circ}C/W$
T_{OPR}	Operating Junction Temperature Range	-40 ~ +125	$^{\circ}C$
T_{STG}	Storage Temperature	-65 ~ +150	$^{\circ}C$
T_{MJ}	Maximum Junction Temperature	150	$^{\circ}C$

Note : Surface mounted on 1 in² copper pad of FR-4 board, $t \leq 5s$; 120 $^{\circ}C/W$ at steady state; 417 $^{\circ}C/W$ when mounted on minimum copper pad.

Ordering Information

Device	Output Voltage	Package	Shipping
LM1117-ADJN3-0-T1-G	Adjustable	SOT-23 (pb-free lead plating and halogen-free package)	3000 pcs/ tape & reel
LM1117-1.5N3 -0-T1-G	1.5V		
LM1117-1.8N3 -0-T1-G	1.8V		
LM1117-2.5N3 -0-T1-G	2.5V		
LM1117-3.3N3 -0-T1-G	3.3V		
LM1117-5.0N3 -0-T1-G	5.0V		

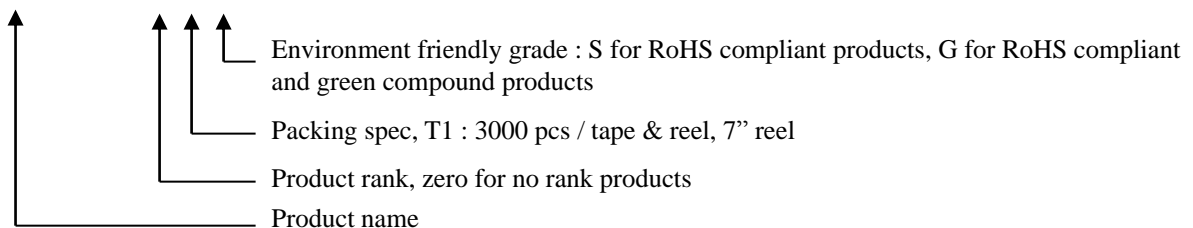

Block Diagram

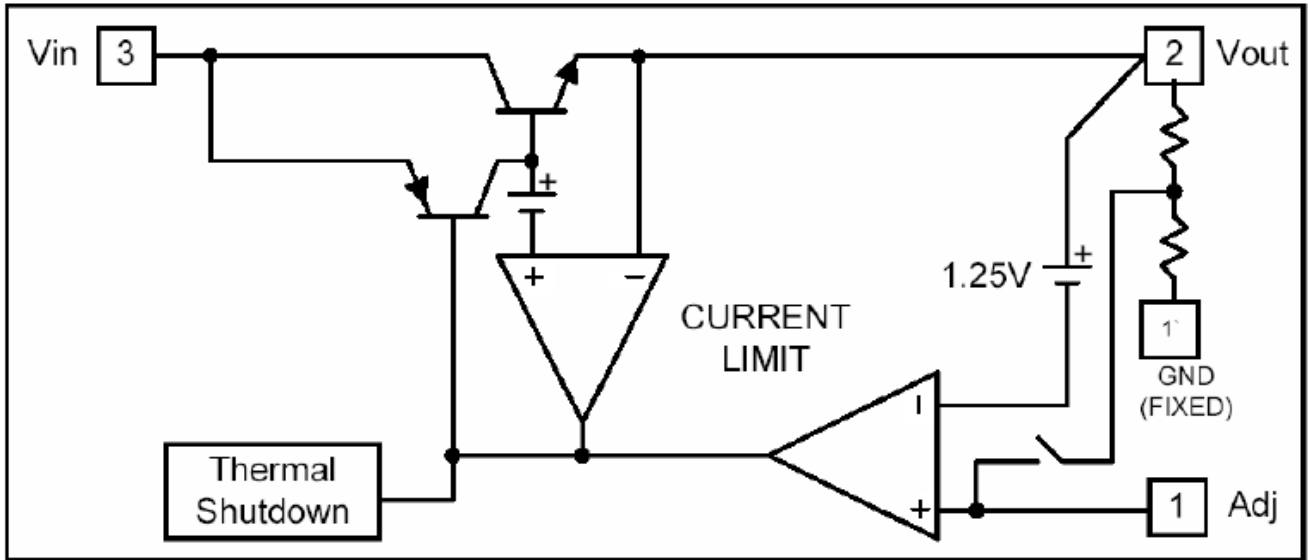

Electrical Characteristics @ $I_o=10mA, T_J=25^\circ C$, unless otherwise specified

Parameter	Device	Test Conditions	Min	Typ	Max	Units
Reference voltage	Adj version	$V_{IN}-V_{OUT}=1.5V$	1.225	1.250	1.275	V
Output Voltage	LM1117-1.5	$3.0V \leq V_{IN} \leq 12V$	1.470	1.500	1.530	V
	LM1117-1.8	$3.3V \leq V_{IN} \leq 12V$	1.764	1.800	1.836	V
	LM1117-2.5	$4.0V \leq V_{IN} \leq 12V$	2.450	2.500	2.550	V
	LM1117-3.3	$4.8V \leq V_{IN} \leq 12V$	3.235	3.300	3.365	V
	LM1117-5.0	$6.5V \leq V_{IN} \leq 12V$	4.900	5.000	5.100	V
Line Regulation	All version	$V_{OUT}+1.5V \leq V_{IN} \leq 12V$	-	-	0.2	%
Load Regulation (Note 1, 2)	LM1117-ADJ	$V_{IN}=3.3V, V_{adj}=0, 10mA \leq I_o \leq 0.5A$	-	-	1	%
	LM1117-1.5	$V_{IN}=3.0V, 0mA \leq I_o \leq 0.5A$	-	12	15	mV
	LM1117-1.8	$V_{IN}=3.3V, 0mA \leq I_o \leq 0.5A$	-	15	18	mV
	LM1117-2.5	$V_{IN}=4.0V, 0mA \leq I_o \leq 0.5A$	-	20	25	mV
	LM1117-3.3	$V_{IN}=5.0V, 0mA \leq I_o \leq 0.5A$	-	26	33	mV
	LM1117-5.0	$V_{IN}=8.0V, 0mA \leq I_o \leq 0.5A$	-	40	50	mV
Dropout Voltage ($V_{IN}-V_{OUT}$)	All version	$I_o=0.5A (\Delta V_{OUT}=1\% V_{OUT})$	-	1.3	1.4	V
Current Limit	All version	$V_{IN}-V_{OUT}=5V$	0.7	-	-	A
Minimum Load Current	Adj version	$V_{IN}=5V$	-	5	10	mA
Adjust Pin Current	Adj version	$V_{IN}=12V, I_o=10mA$	-	50	100	μA
Quiescent Current	Fixed version	$V_{IN}=12V, I_o=0mA$	-	-	12	mA

Thermal Regulation	All version	$T_A=25^{\circ}\text{C}$, 30ms pulse	-	0.008	0.04	%/W
Ripple Rejection	All version	$f=120\text{Hz}$, $V_{IN}=V_{OUT}+3\text{V}$, $I_O=0.7\text{A}$, $C_{OUT}=25\mu\text{F}$ tantalum	60	70	-	dB
Temperature Stability	All version	$I_O=10\text{mA}$	-	0.5	-	%

Note : 1. See thermal regulation specifications for changes in output voltage due to heating effects. Line and load regulation are measured at a constant junction temperature by low duty cycle pulse testing.
 2. Line and load regulation are guaranteed up to the maximum power dissipation of 1W when device is mounted on FR-4 board and the pulse width is less than 5s. Power dissipation is determined by the difference in input and output voltage and the output current. Guaranteed maximum power dissipation will not be available over the full input/output range.

Recommended soldering footprint

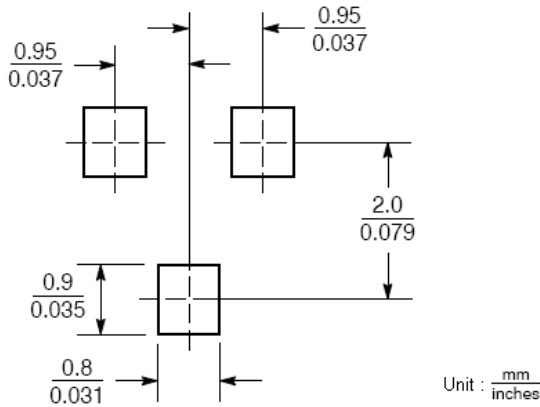

Typical Characteristics

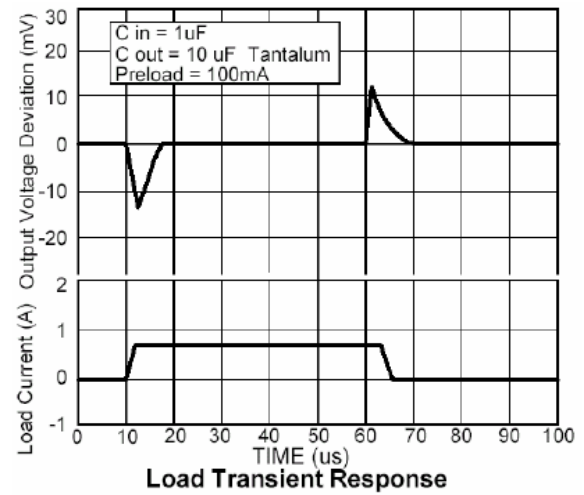
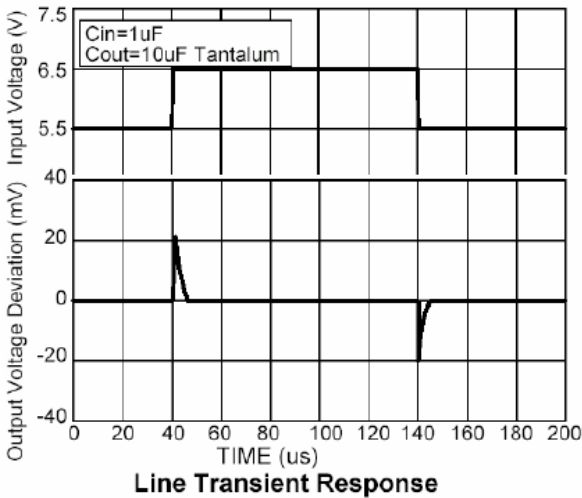
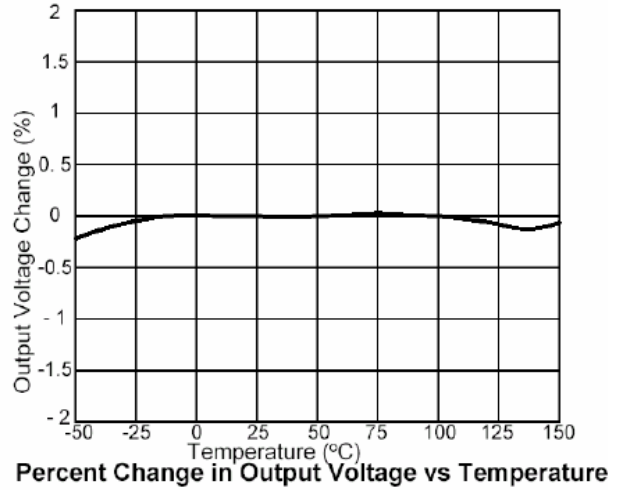
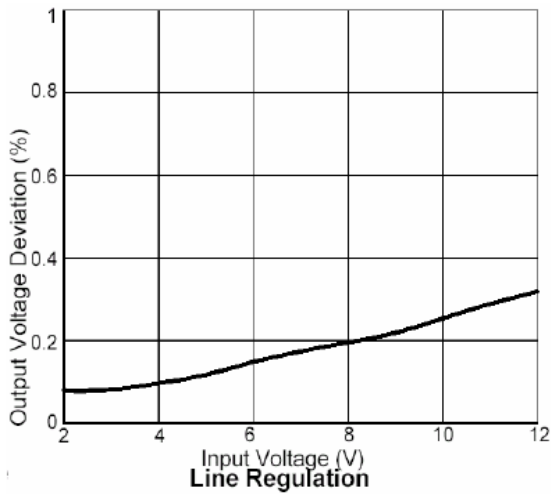
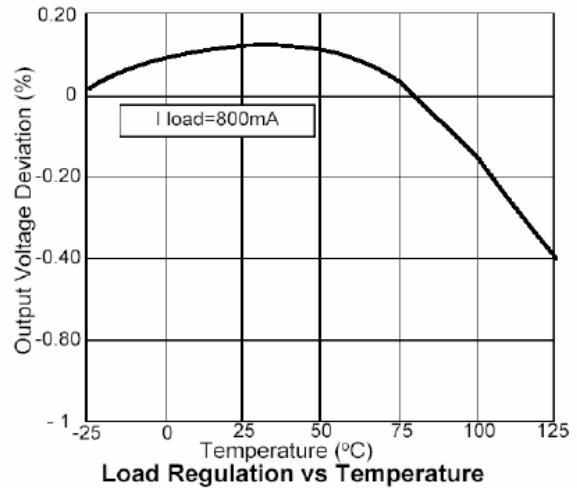
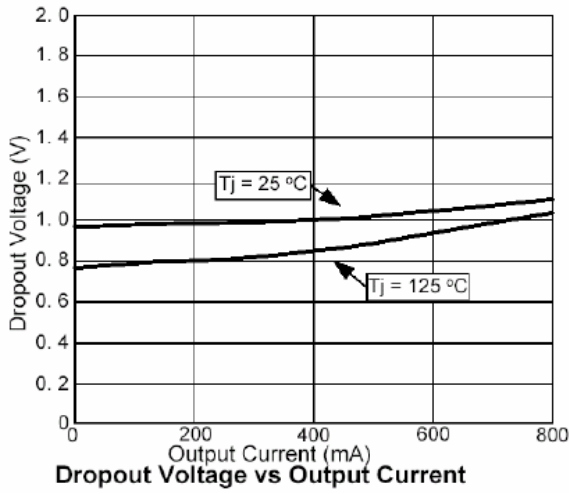

Reel Dimension



Carrier Tape Dimension

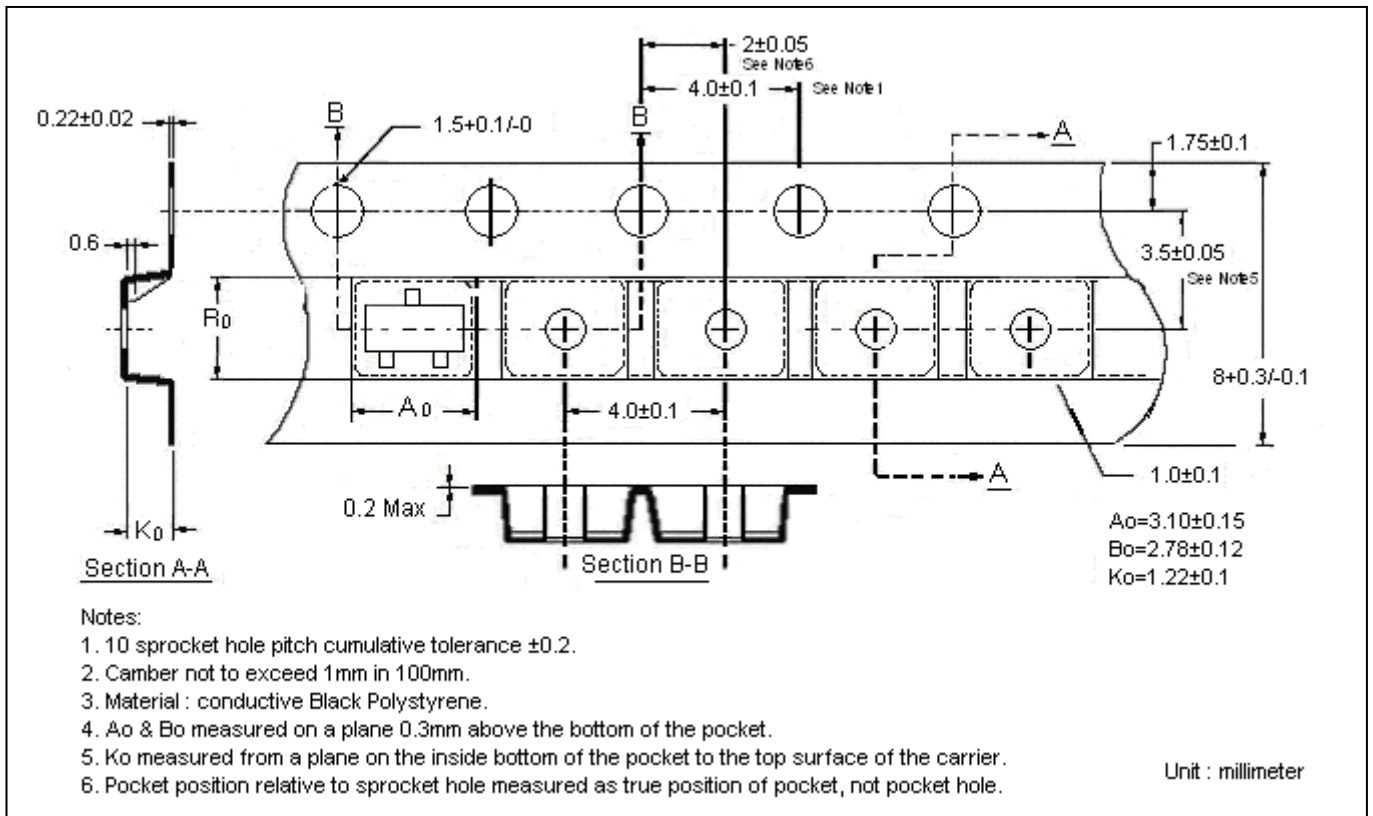

Recommended wave soldering condition

Product	Peak Temperature	Soldering Time
Pb-free devices	260 +0/-5 °C	5 +1/-1 seconds

Recommended temperature profile for IR reflow

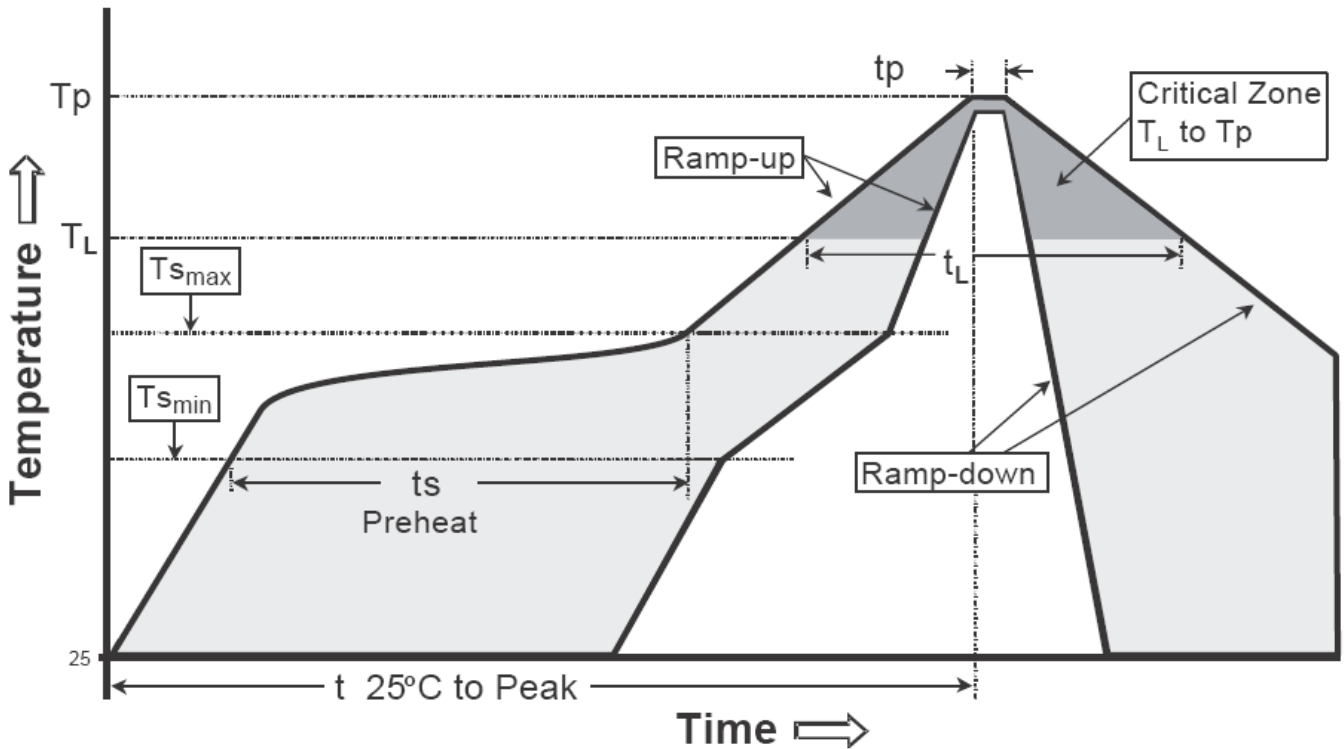

Profile feature	Sn-Pb eutectic Assembly	Pb-free Assembly
Average ramp-up rate (T _{smax} to T _p)	3°C/second max.	3°C/second max.
Preheat		
-Temperature Min(T _{s min})	100°C	150°C
-Temperature Max(T _{s max})	150°C	200°C
-Time(t _{s min} to t _{s max})	60-120 seconds	60-180 seconds
Time maintained above:		
-Temperature (T _L)	183°C	217°C
- Time (t _L)	60-150 seconds	60-150 seconds
Peak Temperature(T _p)	240 +0/-5 °C	260 +0/-5 °C
Time within 5°C of actual peak temperature(tp)	10-30 seconds	20-40 seconds
Ramp down rate	6°C/second max.	6°C/second max.
Time 25 °C to peak temperature	6 minutes max.	8 minutes max.

Note : All temperatures refer to topside of the package, measured on the package body surface.

SOT-23 Dimension

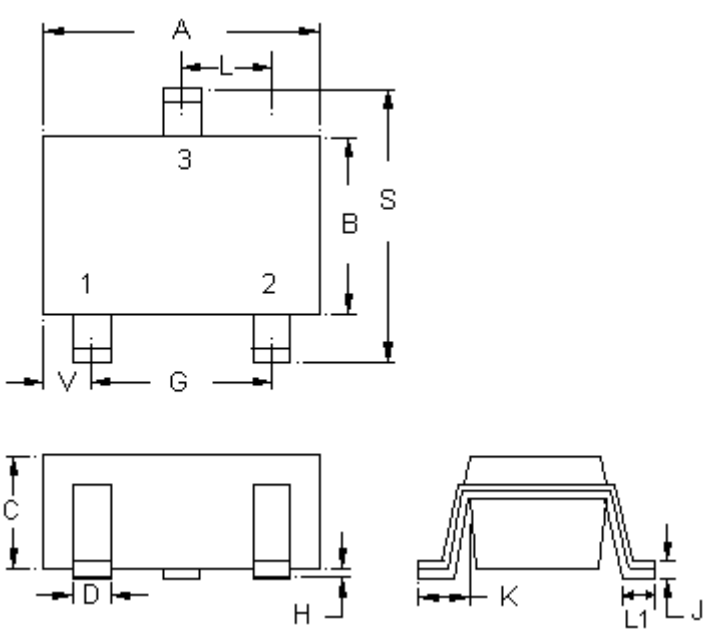

Marking:

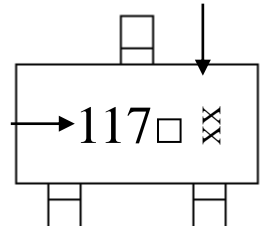

Device Code → 117 □ ×

Date Code → XX

□ : A → Adj XX : year (bottom)+month
 0 → 1.5V year code : the last digit of
 1 → 1.8V christian year
 2 → 2.5V month code : 1~9 for Jan
 3 → 3.3V thru Sep, A~C for Oct thru
 5 → 5.0V Dec

Style : Pin 1.Adj/GND 2.Input 3.Output

3-Lead SOT-23 Plastic
 Surface Mounted Package
 CYStek Package Code: N3

*:Typical

DIM	Inches		Millimeters		DIM	Inches		Millimeters	
	Min.	Max.	Min.	Max.		Min.	Max.	Min.	Max.
A	0.1102	0.1204	2.80	3.04	J	0.0032	0.0079	0.08	0.20
B	0.0472	0.0669	1.20	1.70	K	0.0118	0.0266	0.30	0.67
C	0.0335	0.0512	0.89	1.30	L	0.0335	0.0453	0.85	1.15
D	0.0118	0.0197	0.30	0.50	S	0.0830	0.1161	2.10	2.95
G	0.0669	0.0910	1.70	2.30	V	0.0098	0.0256	0.25	0.65
H	0.0000	0.0040	0.00	0.10	L1	0.0118	0.0197	0.30	0.50

Notes : 1.Controlling dimension : millimeters.
 2.Maximum lead thickness includes lead finish thickness, and minimum lead thickness is the minimum thickness of base material.
 3.If there is any question with packing specification or packing method, please contact your local CYStek sales office.

Material :

- Lead : Pure tin plated.
- Mold Compound : Epoxy resin family, flammability solid burning class:UL94V-0.

Important Notice:

- All rights are reserved. Reproduction in whole or in part is prohibited without the prior written approval of CYStek.
- CYStek reserves the right to make changes to its products without notice.
- CYStek **semiconductor products are not warranted to be suitable for use in Life-Support Applications, or systems.**
- CYStek assumes no liability for any consequence of customer product design, infringement of patents, or application assistance.