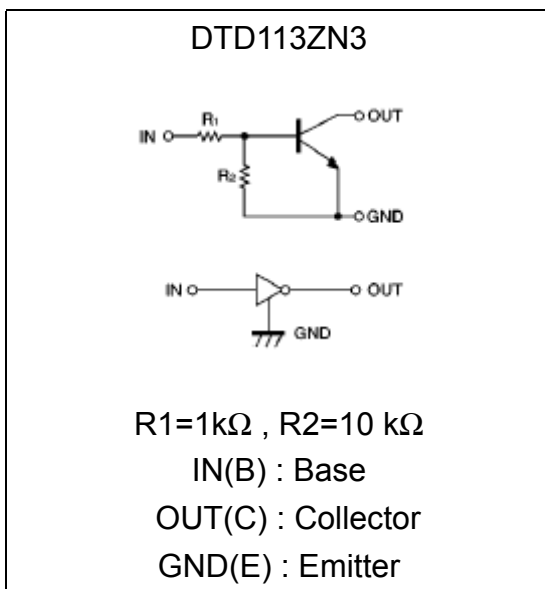
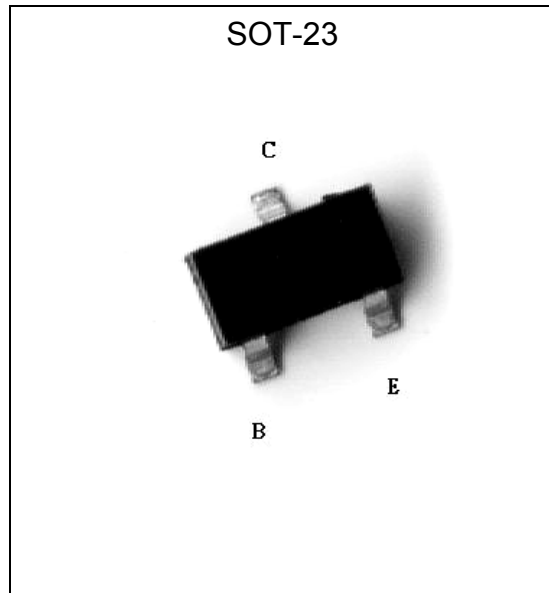

NPN Digital Transistors (Built-in Resistors)

DTD113ZN3

Features

- Built-in bias resistors enable the configuration of an inverter circuit without connecting external input resistors (see equivalent circuit).
- The bias resistors consist of thin-film resistors with complete isolation to allow negative biasing of the input. They also have the advantage of almost completely eliminating parasitic effects.
- Only the on/off conditions need to be set for operation, making device design easy.
- Complements the DTB113ZN3

Equivalent Circuit

Outline

Absolute Maximum Ratings (Ta=25°C)

Parameter	Symbol	Limits	Unit
Supply Voltage	V _{CC}	50	V
Input Voltage	V _{IN}	-5~+10	V
Output Current	I _o	500	mA
Power Dissipation	P _d	200	mW
Junction Temperature	T _j	150	°C
Storage Temperature	T _{stg}	-55~+150	°C



Characteristics (Ta=25°C)

Parameter	Symbol	Min.	Typ.	Max.	Unit	Test Conditions
Input Voltage	$V_{I(off)}$	-	-	0.3	V	$V_{CC}=5V, I_o=100\mu A$
	$V_{I(on)}$	3	-	-	V	$V_o=0.3V, I_o=20mA$
Output Voltage	$V_{O(on)}$	-	0.1	0.3	V	$I_o/I_i=50mA/2.5mA$
Input Current	I_i	-	-	7.2	mA	$V_i=5V$
Output Current	$I_{O(off)}$	-	-	0.5	μA	$V_{CC}=50V, V_i=0V$
DC Current Gain	G_i	56	-	-	-	$V_o=5V, I_o=50mA$
Input Resistance	R_i	0.7	1	1.3	k Ω	-
Resistance Ratio	R_2/R_1	8	10	12	-	-
Transition Frequency	f_T	-	200	-	MHz	$V_{CE}=10V, I_C=5mA, f=100MHz$ *

* Transition frequency of the device



Characteristic Curves

Current Gain vs Output Current

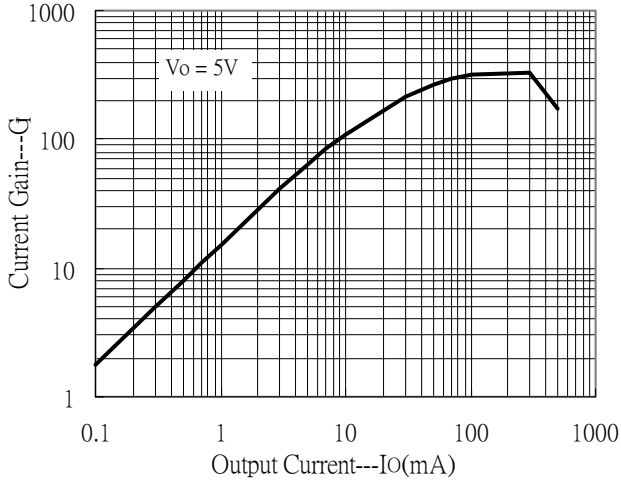

Output Voltage vs Output Current

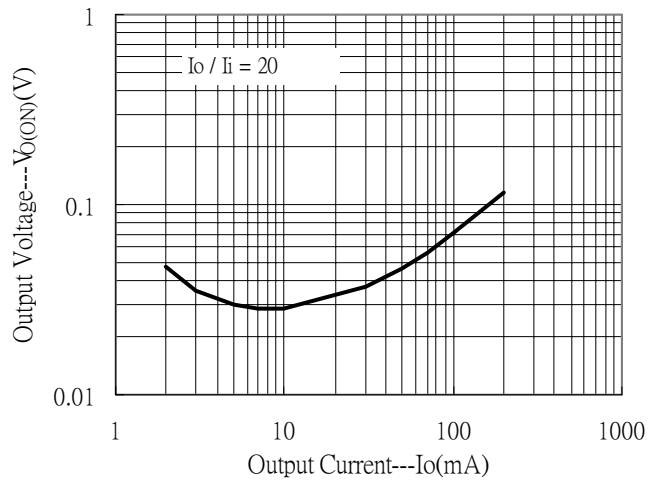

Input Voltage vs Output Current(ON characteristics)

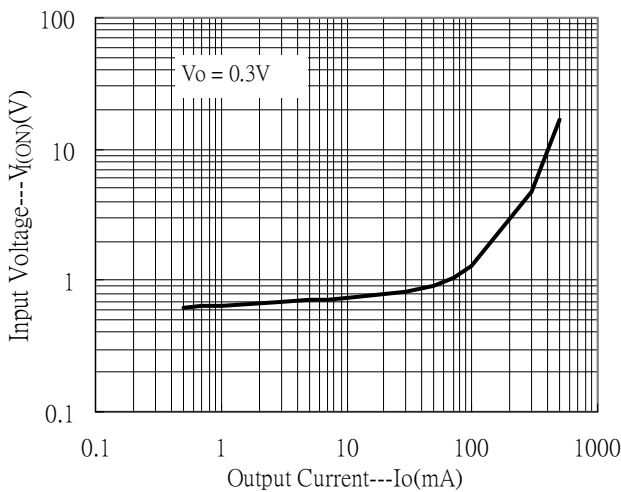

Output Current vs Input Voltage(OFF characteristics)

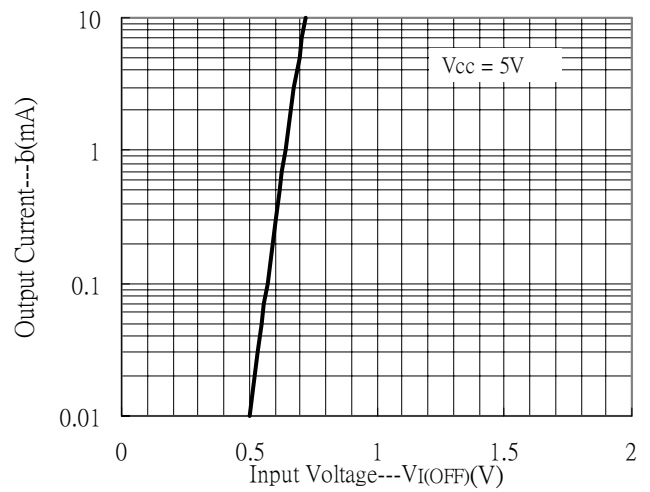

Power Derating Curve

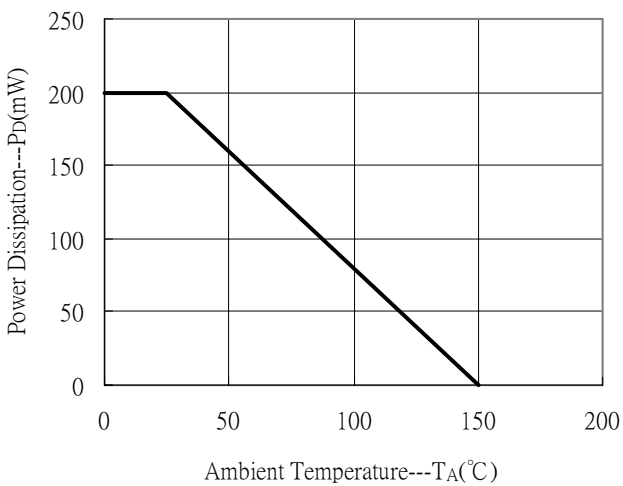

SOT-23 Dimension

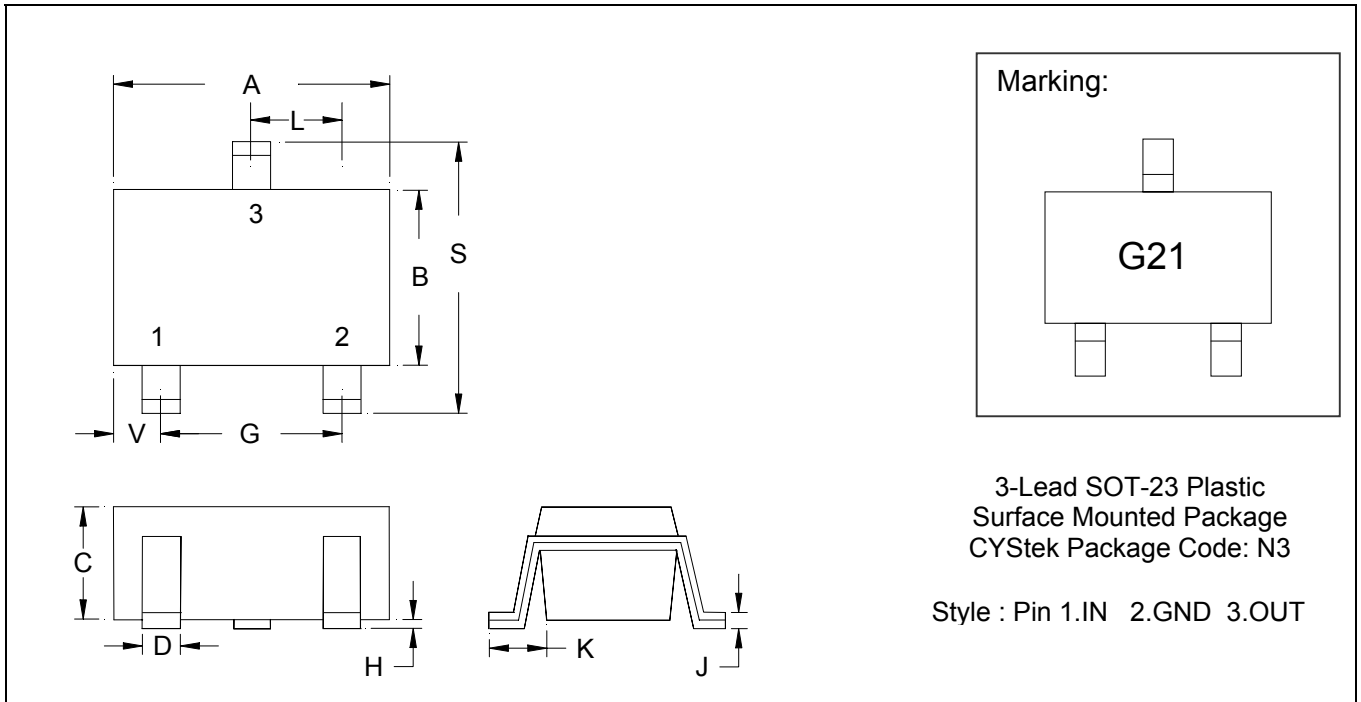

Marking:

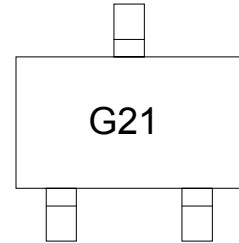

3-Lead SOT-23 Plastic
 Surface Mounted Package
 CYStek Package Code: N3

Style : Pin 1.IN 2.GND 3.OUT

*:Typical

DIM	Inches		Millimeters		DIM	Inches		Millimeters	
	Min.	Max.	Min.	Max.		Min.	Max.	Min.	Max.
A	0.1102	0.1204	2.80	3.04	J	0.0034	0.0070	0.085	0.177
B	0.0472	0.0630	1.20	1.60	K	0.0128	0.0266	0.32	0.67
C	0.0335	0.0512	0.89	1.30	L	0.0335	0.0453	0.85	1.15
D	0.0118	0.0197	0.30	0.50	S	0.0830	0.1083	2.10	2.75
G	0.0669	0.0910	1.70	2.30	V	0.0098	0.0256	0.25	0.65
H	0.0005	0.0040	0.013	0.10					

- Notes : 1.Controlling dimension : millimeters.
 2.Maximum lead thickness includes lead finish thickness, and minimum lead thickness is the minimum thickness of base material.
 3.If there is any question with packing specification or packing method, please contact your local CYStek sales office.

Material :

- Lead : 42 Alloy ; solder plating
- Mold Compound : Epoxy resin family, flammability solid burning class:UL94V-0

Important Notice:

- All rights are reserved. Reproduction in whole or in part is prohibited without the prior written approval of CYStek.
- CYStek reserves the right to make changes to its products without notice.
- CYStek **semiconductor products are not warranted to be suitable for use in Life-Support Applications, or systems.**
- CYStek assumes no liability for any consequence of customer product design, infringement of patents, or application assistance.