

**NPN Digital Transistors (Built-in Resistors)**

# DTC115EN3

## Features

- Built-in bias resistors enable the configuration of an inverter circuit without connecting external input resistors (see equivalent circuit).
- The bias resistors consist of thin-film resistors with complete isolation to allow negative biasing of the input. They also have the advantage of almost completely eliminating parasitic effects.
- Only the on/off conditions need to be set for operation, making device design easy.
- Complements the DTA115EN3
- Pb-free lead plating and halogen-free package

## Equivalent Circuit

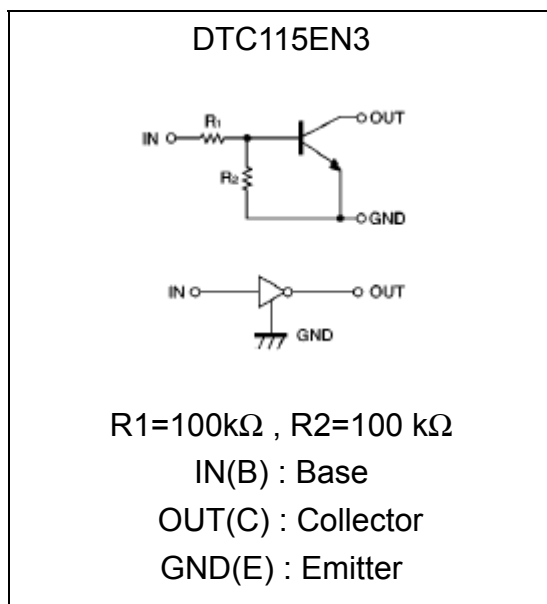

## Outline

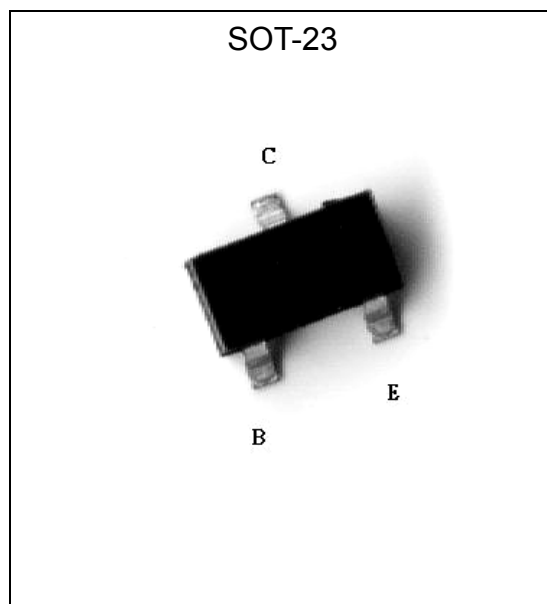

## Ordering Information

Device	Package	Shipping
DTC115EN3-0-T1-G	SOT-23 (Pb-free lead plating and halogen-free package)	3000 pcs / tape & reel

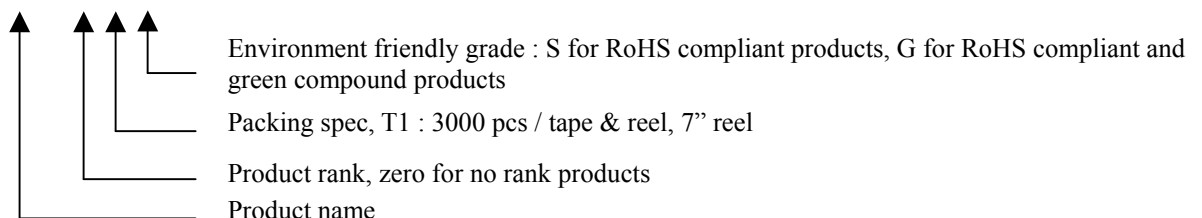

**Absolute Maximum Ratings** (Ta=25°C)

Parameter	Symbol	Limits	Unit
Supply Voltage	V <sub>CC</sub>	50	V
Input Voltage	V <sub>IN</sub>	-10~+40	V
Output Current	I <sub>O</sub>	20	mA
	I <sub>O(max.)</sub>	100	mA
Power Dissipation	P <sub>d</sub>	200	mW
Operating Junction Temperature Range	T <sub>j</sub>	-55~+150	°C
Storage Temperature Range	T <sub>stg</sub>	-55~+150	°C

**Characteristics** (Ta=25°C)

Parameter	Symbol	Min.	Typ.	Max.	Unit	Test Conditions
Input Voltage	V <sub>I(off)</sub>	-	-	0.5	V	V <sub>CC</sub> =5V, I <sub>O</sub> =100μA
	V <sub>I(on)</sub>	3	-	-	V	V <sub>O</sub> =0.3V, I <sub>O</sub> =1mA
Output Voltage	V <sub>O(on)</sub>	-	0.1	0.3	V	I <sub>O</sub> /I <sub>I</sub> =5mA/0.25mA
Input Current	I <sub>I</sub>	-	-	0.15	mA	V <sub>I</sub> =5V
Output Current	I <sub>O(off)</sub>	-	-	0.5	μA	V <sub>CC</sub> =50V, V <sub>I</sub> =0V
DC Current Gain	G <sub>I</sub>	82	-	-	-	V <sub>O</sub> =5V, I <sub>O</sub> =5mA
Input Resistance	R <sub>1</sub>	70	100	130	kΩ	-
Resistance Ratio	R <sub>2</sub> /R <sub>1</sub>	0.8	1	1.2	-	-
Transition Frequency	f <sub>T</sub>	-	250	-	MHz	V <sub>CE</sub> =10V, I <sub>C</sub> =5mA, f=100MHz*

\* Transition frequency of the device

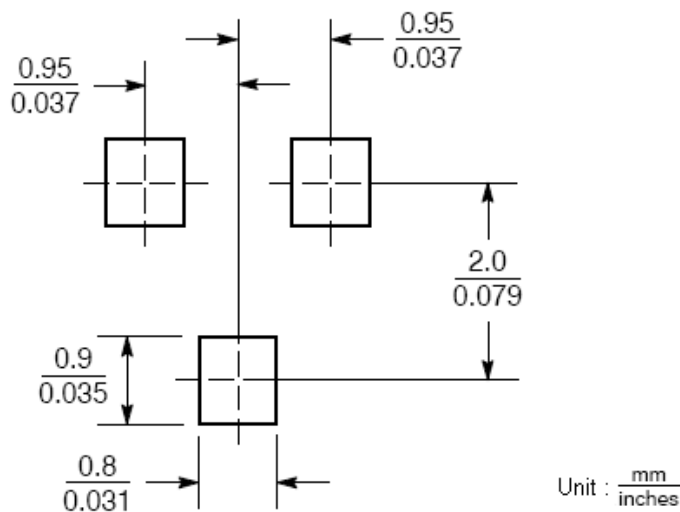
**Recommended Soldering Footprint**



### Typical Characteristics

Current Gain vs Output Current

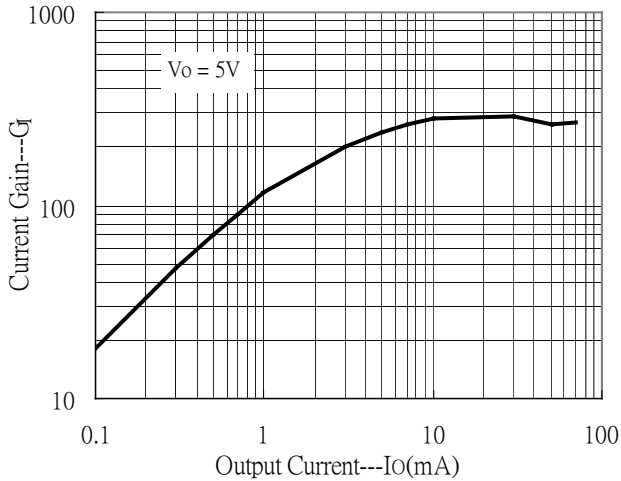

Output Voltage vs Output Current

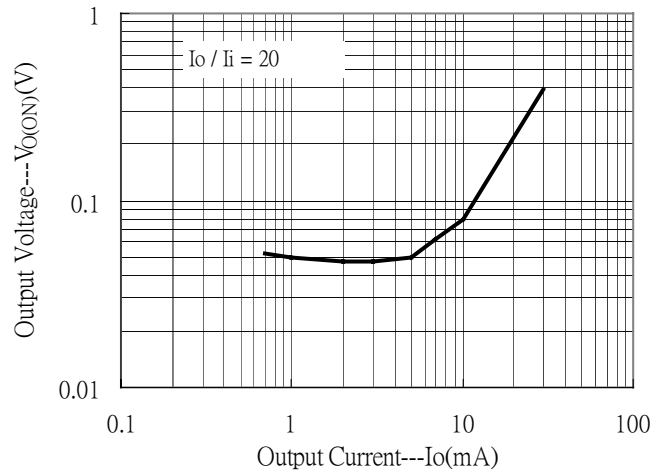

Input Voltage vs Output Current(ON characteristics)

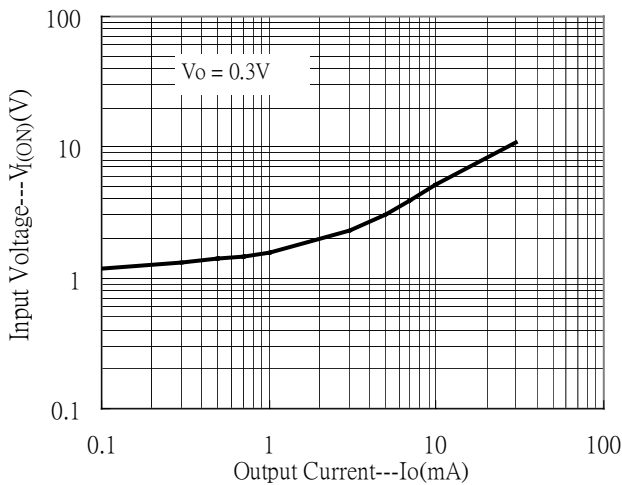

Output Current vs Input Voltage(OFF characteristics)

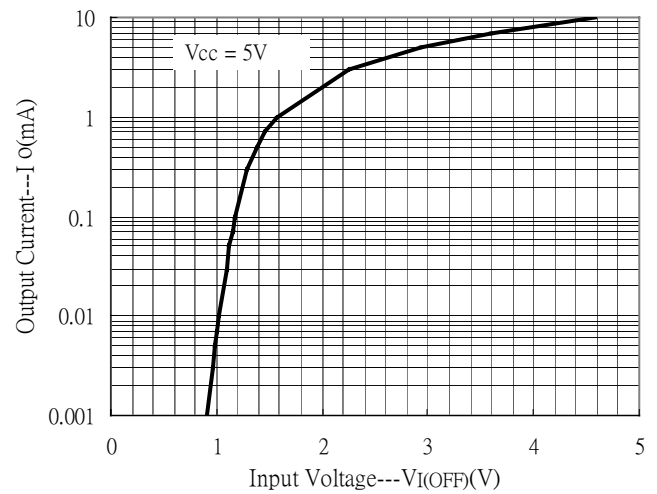

Power Derating Curve

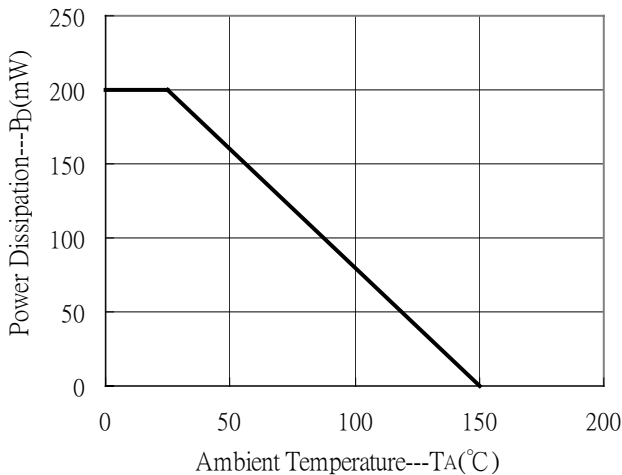

**Reel Dimension**

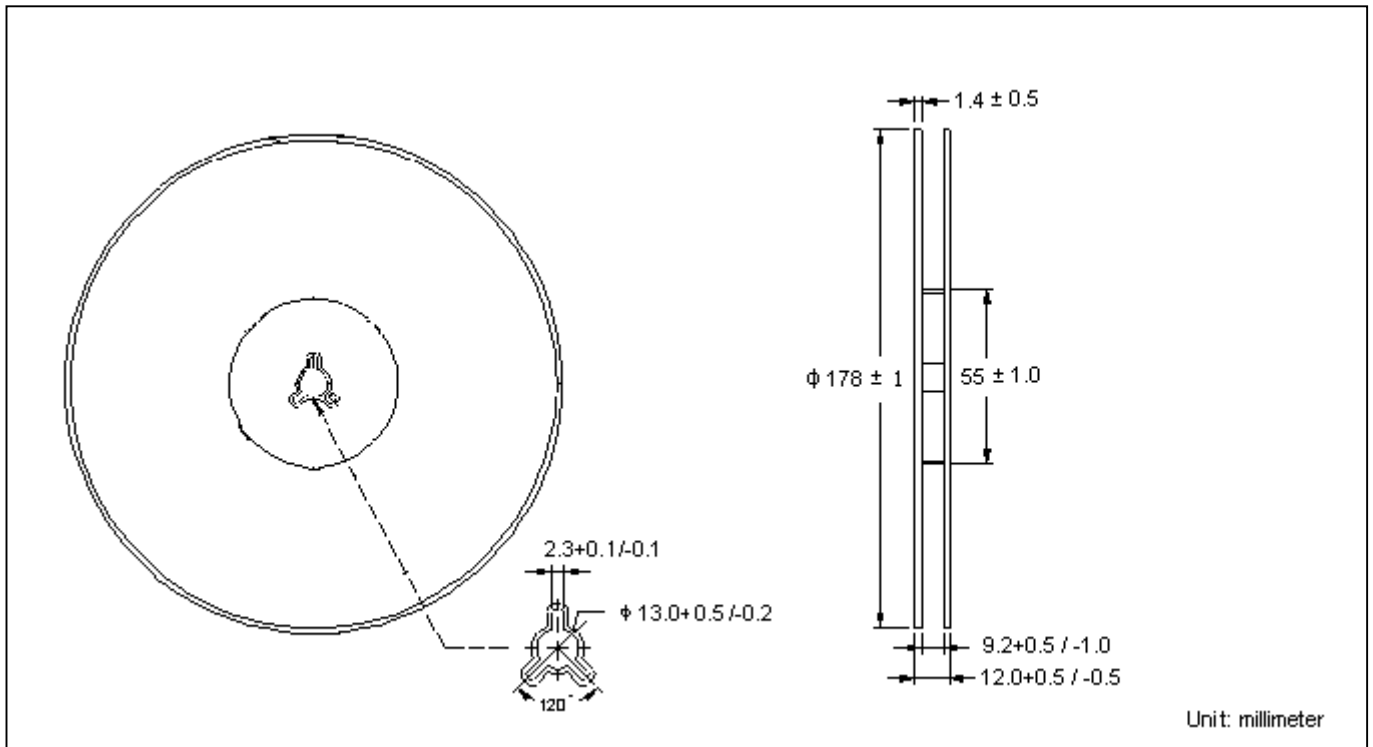

**Carrier Tape Dimension**

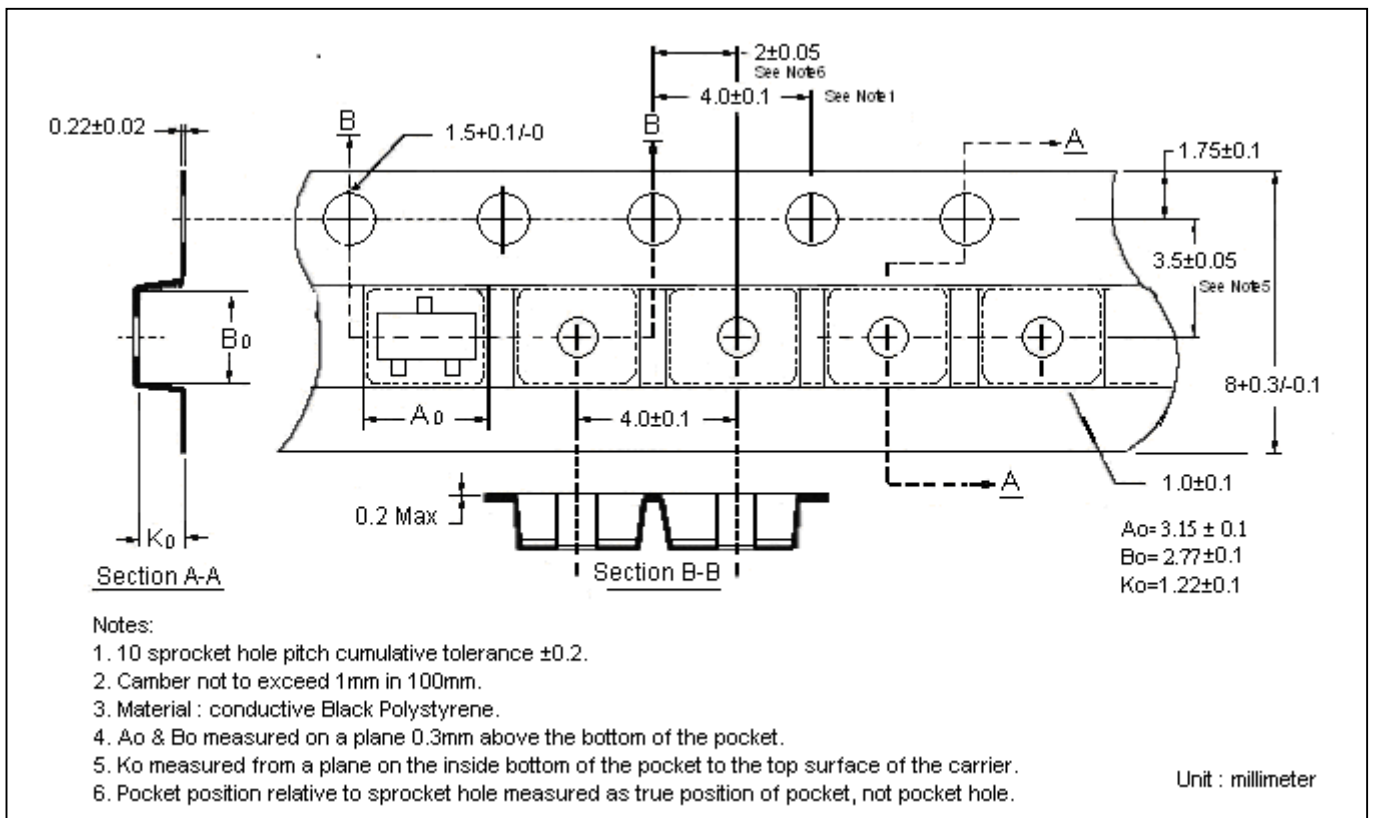

**Recommended wave soldering condition**

Product	Peak Temperature	Soldering Time
Pb-free devices	260 +0/-5 °C	5 +1/-1 seconds

**Recommended temperature profile for IR reflow**

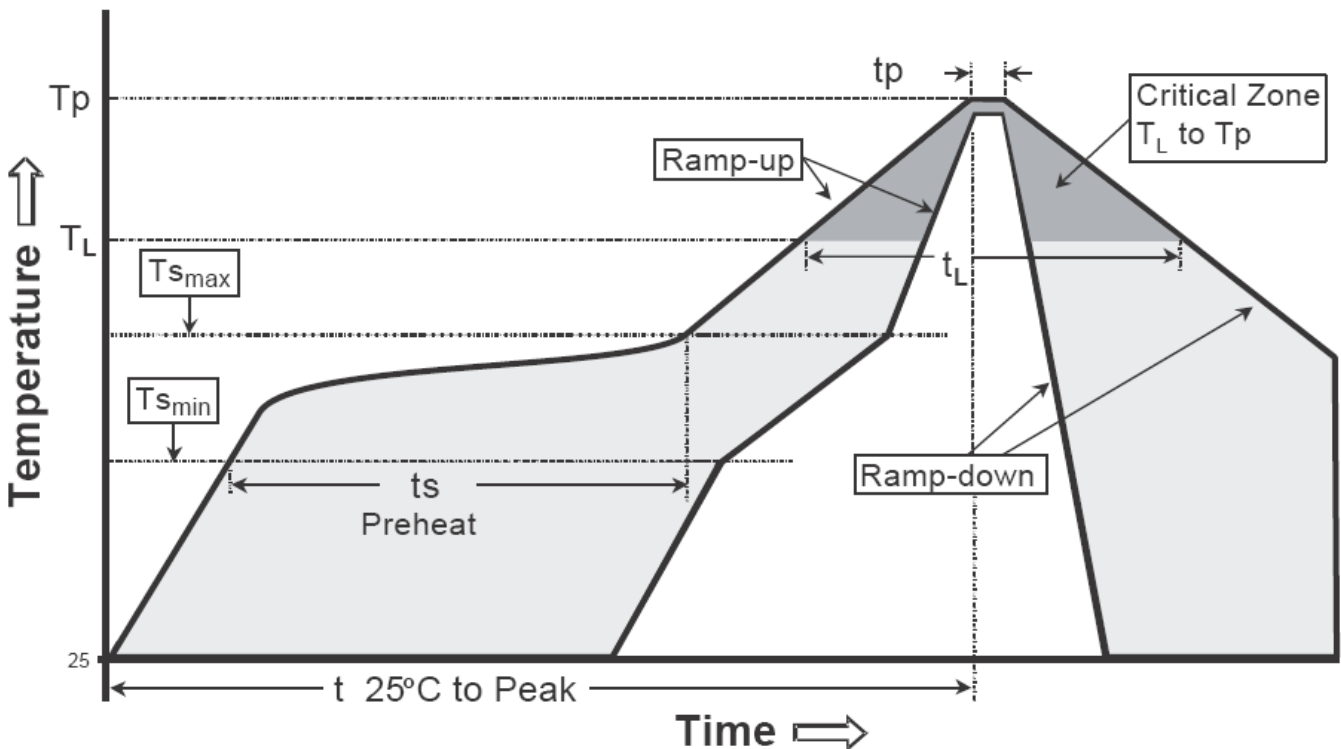

Profile feature	Sn-Pb eutectic Assembly	Pb-free Assembly
Average ramp-up rate (Tsmax to Tp)	3°C/second max.	3°C/second max.
Preheat		
-Temperature Min(Ts min)	100°C	150°C
-Temperature Max(Ts max)	150°C	200°C
-Time(ts min to ts max)	60-120 seconds	60-180 seconds
Time maintained above:		
-Temperature (T <sub>L</sub> )	183°C	217°C
- Time (t <sub>L</sub> )	60-150 seconds	60-150 seconds
Peak Temperature(T <sub>P</sub> )	240 +0/-5 °C	260 +0/-5 °C
Time within 5°C of actual peak temperature(tp)	10-30 seconds	20-40 seconds
Ramp down rate	6°C/second max.	6°C/second max.
Time 25 °C to peak temperature	6 minutes max.	8 minutes max.

Note : All temperatures refer to topside of the package, measured on the package body surface.

**SOT-23 Dimension**

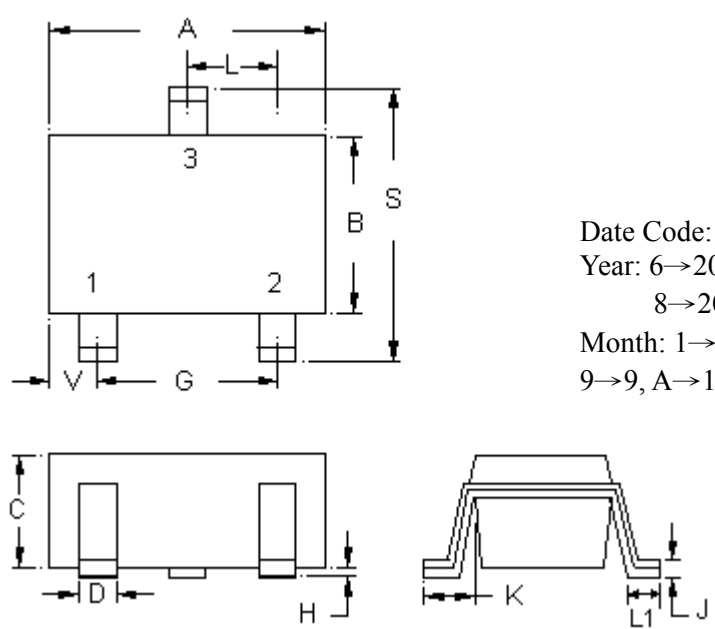

The diagram shows three views of the SOT-23 package: a top view with dimensions A, B, C, G, S, V, and L; a side view with dimensions C, D, H, and J; and a perspective view with dimensions K, L1, and L2. The top view also labels the pins as 1, 2, and 3.

**Marking:**

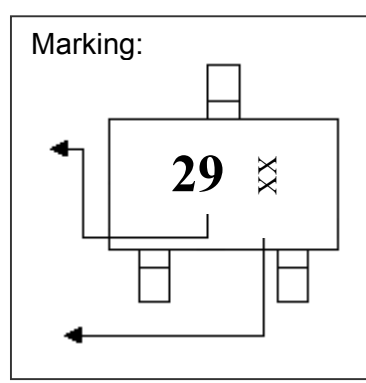

The marking diagram shows a rectangular package with three pins. The top pin is labeled '29' and the bottom right pin is labeled 'XX'. Arrows indicate the pin connections: Pin 1 (left), Pin 2 (right), and Pin 3 (top).

**Product Code**

**Date Code: Year+Month**  
 Year: 6→2016, 7→2017,  
 8→2018, . . . , etc  
 Month: 1→1, 2→2, . . .  
 9→9, A→10, B→11, C→12

**3-Lead SOT-23 Plastic Surface Mounted Package**  
 CYStek Package Code: N3

**Style : Pin 1.Base 2.Emitter 3.Collector**

\*:Typical

DIM	Inches		Millimeters		DIM	Inches		Millimeters	
	Min.	Max.	Min.	Max.		Min.	Max.	Min.	Max.
A	0.1102	0.1204	2.80	3.04	J	0.0032	0.0079	0.08	0.20
B	0.0472	0.0551	1.20	1.40	K	0.0118	0.0266	0.30	0.67
C	0.0335	0.0512	0.89	1.30	L	0.0335	0.0453	0.85	1.15
D	0.0118	0.0197	0.30	0.50	S	0.0830	0.1004	2.10	2.55
G	0.0669	0.0910	1.70	2.30	V	0.0098	0.0256	0.25	0.65
H	0.0000	0.0040	0.00	0.10	L1	0.0118	0.0197	0.30	0.50

- Notes :** 1.Controlling dimension : millimeters.  
 2.Maximum lead thickness includes lead finish thickness, and minimum lead thickness is the minimum thickness of base material.  
 3.If there is any question with packing specification or packing method, please contact your local CYStek sales office.

**Material :**

- Lead : Pure tin plated.
- Mold Compound : Epoxy resin family, flammability solid burning class:UL94V-0.

**Important Notice:**

- All rights are reserved. Reproduction in whole or in part is prohibited without the prior written approval of CYStek.
- CYStek reserves the right to make changes to its products without notice.
- CYStek **semiconductor products are not warranted to be suitable for use in Life-Support Applications, or systems.**
- CYStek assumes no liability for any consequence of customer product design, infringement of patents, or application assistance.