

Switching Control Diode

DISP0165CTSP

Features

- High current capability
- Smoothly soft reverse recovery time (trr)
- Low profile surface mounted package in order to minimize board space
- Pb-free lead plating and halogen-free package

Mechanical data

- Case : TO-277 Molded plastic
- Epoxy : UL94-V0 rated flame retardant
- Terminals : Plated terminals, solderable per MIL-STD-202 method 208
- Weight : approx. 0.093 gram

Symbol

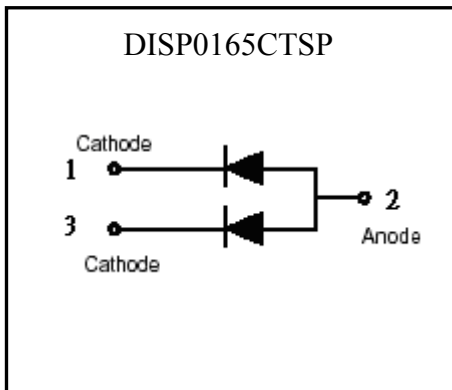

Outline

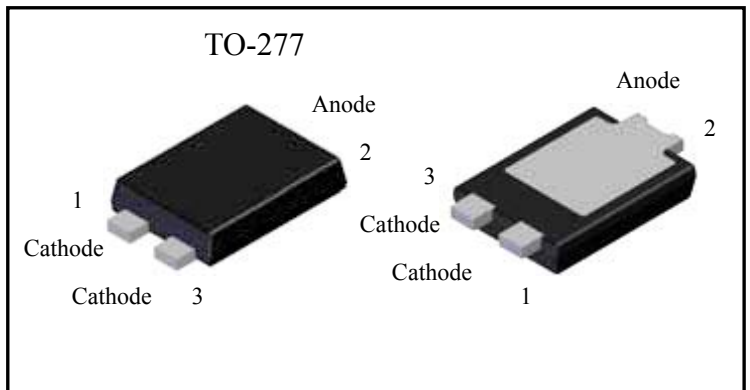

Ordering Information

Device	Package	Shipping
DISP0165CTSP-0-T6-G	TO-277 (Pb-free lead plating and halogen-free package)	3000 pcs / tape & reel

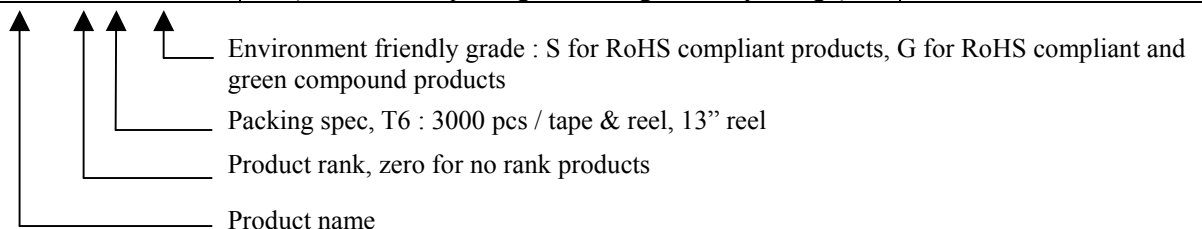

**The following specifications apply to each die****Absolute Maximum Ratings** ($T_A=25^{\circ}\text{C}$, unless otherwise noted)

Parameters	Conditions	Symbol	Value	Units
Repetitive peak reverse voltage		V_{RRM}	650	V
RMS voltage		V_{RMS}	455	V
Continuous reverse voltage		V_R	650	V
Forward rectified current (per die)	Single phase half wave, 60Hz @ $T_J=25^{\circ}\text{C}$	$I_{F(AV)}$	1	A
Repetitive Peak Forward Current (per die)	Single phase half wave, 60Hz @ $T_J=25^{\circ}\text{C}$	I_{FRM}	1.57	A
Forward surge current (per die)	8.3ms single half sine-wave superimposed on rated load (JEDEC method)	I_{FSM}	9	A
Maximum reverse recovery time (per die)	$I_F=1\text{A}$, $dI_F/dt=100\text{A}/\mu\text{s}$	t_{rr}	1000	ns
Storage temperature range		T_{stg}	-55~+150	$^{\circ}\text{C}$
Operating junction temperature range		T_j	-55~+150	$^{\circ}\text{C}$

Thermal Data

Parameter	Symbol	Value	Unit
Thermal Resistance, Junction-to-case, max	$R_{th,j-c}$	10	$^{\circ}\text{C}/\text{W}$
Thermal Resistance, Junction-to-ambient, max (Note 1)	$R_{th,j-a}$	39	
Thermal Resistance, Junction-to-ambient, max (Note 2)		75	
Thermal Resistance, Junction-to-ambient, max (Note 3)		169	
Power Dissipation @ $T_C=25^{\circ}\text{C}$	P_D	12.5	W
Power Dissipation @ $T_A=25^{\circ}\text{C}$ (Note 1)		3.2	
Power Dissipation @ $T_A=25^{\circ}\text{C}$ (Note 2)		1.7	
Power Dissipation @ $T_A=25^{\circ}\text{C}$ (Note 3)		0.74	

- Note: 1. Device mounted on FR-4 PCB, single sided 2 oz. copper, pad dimension 50mmx50mm.
2. Device mounted on FR-4 PCB, single sided 1 oz. copper, pad dimension 25mmx25mm.
3. Device mounted on FR-4 PCB, single sided 1 oz. copper, minimum recommended pad dimension.

Characteristics ($T_A=25^{\circ}\text{C}$, unless otherwise noted)

Characteristic	Symbol	Condition	Min.	Typ	Max.	Unit
Forward Voltage	V_R	$I_R=100\mu\text{A}$	650	-	-	V
	V_{F1}	$I_F=100\text{mA}$	-	-	0.95	V
	V_{F2}	$I_F=500\text{mA}$	-	-	1.2	
Reverse Leakage Current	I_R	$V_R=540\text{V}$	-	-	100	nA
	I_R	$V_R=540\text{V}$, $T_A=125^{\circ}\text{C}$	-	-	10	μA
Junction Capacitance	C_J	$V_R=1\text{V}$, $f=1\text{MHz}$	-	11.6	-	pF

Typical Characteristics (Per die)

Power Derating Curve

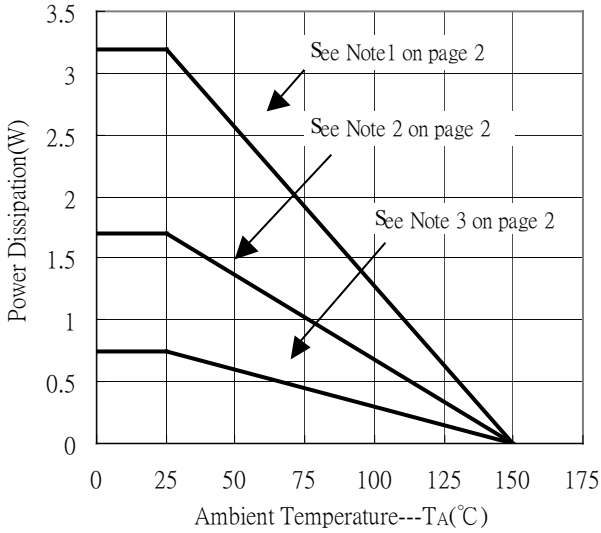

Forward Current vs Forward Voltage

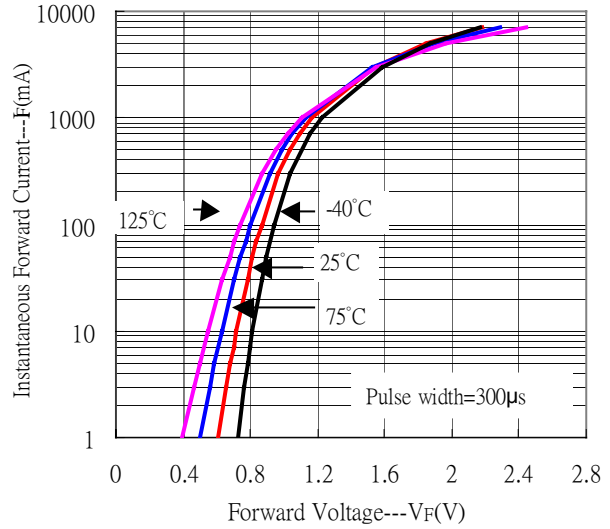

Reverse Leakage Current vs Reverse Voltage

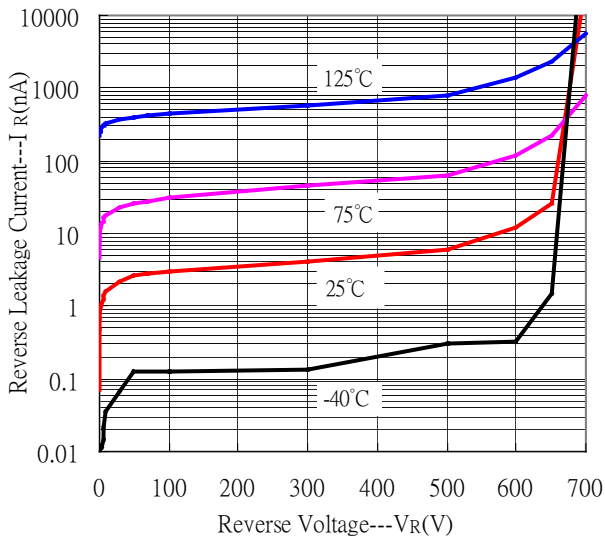

Junction Capacitance vs Reverse Voltage

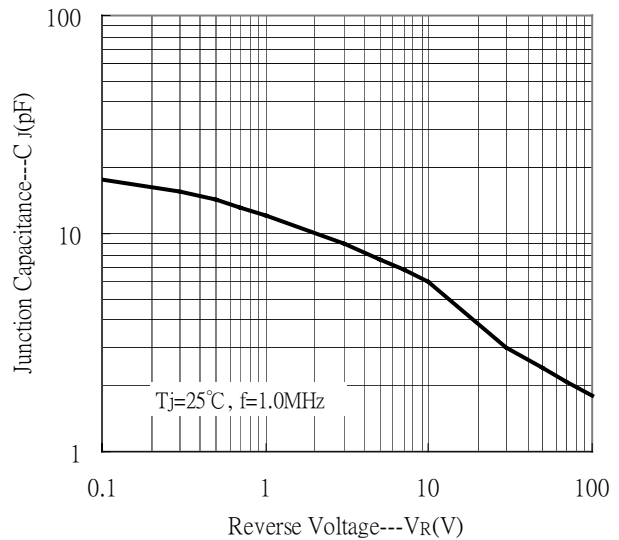

Recommended Soldering Footprint

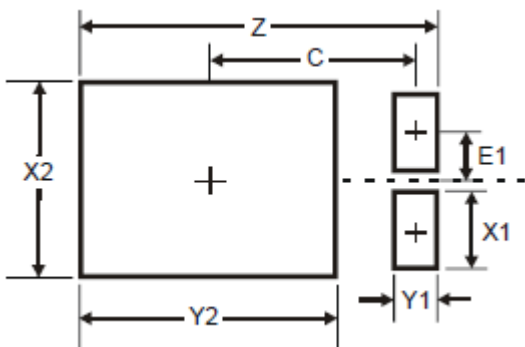

Dimensions	Value (in mm)
Z	6.6
X1	1.4
X2	3.6
Y1	0.8
Y2	4.7
C	3.87
E1	0.9

Reel Dimension

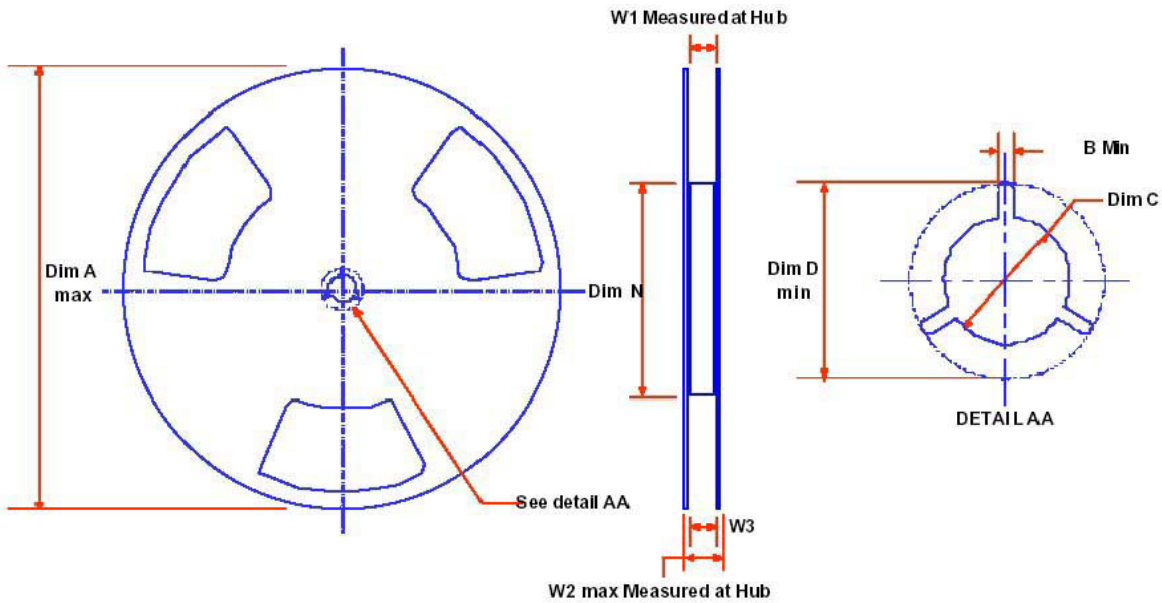

Dimensions are in inches and millimeters

Tape Size	Reel Option	Dim A	Dim B	Dim C	Dim D	Dim N	Dim W1	Dim W2	Dim W3 (LSL-USL)
12mm	13" Dia (STD/L99Z)	1300 330+/-1	0.069 1.5 Min.	0.512 13.0 Min.	0.795 20.2(ref.)	7.00 178+0/-2	0.488 +0.078/-0.000 12.4 +2/0	0.724 18.4(ref.)	0.469 - 0.606 11.9 - 15.4

Carrier Tape Dimension

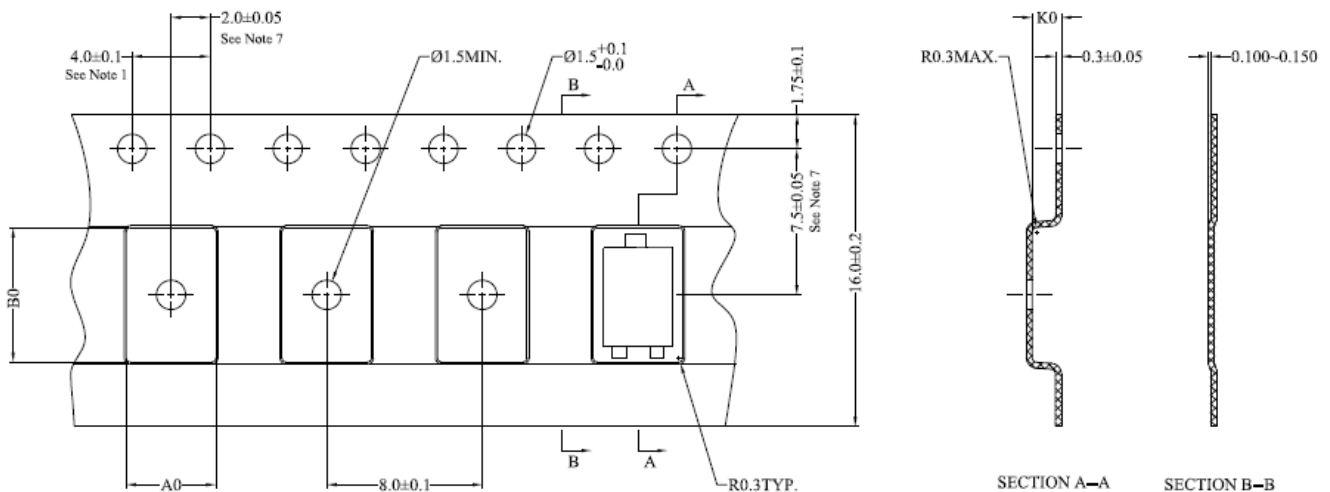

NOTE:

1. 10 SPROCKET HOLE PITCH CUMULATIVE TOLERANCE ± 0.2
2. CAMBER NOT TO EXCEED 1mm IN 100mm, NONCUMULATIVE OVER 250mm.
3. MATERIAL: BLACK STATIC DISSIPATIVE PS (POLYSTYRENE)
4. ALL DIMENSIONS ARE IN MILLIMETERS (UNLESS OTHERWISE SPECIFIED)
5. A0 AND B0 MEASURED ON A PLANE 0.3mm ABOVE THE BOTTOM OF THE POCKET
6. K0 MEASURED FROM A PLANE ON THE INSIDE BOTTOM OF THE POCKET TO THE TOP SURFACE OF THE CARRIER
7. POCKET POSITION RELATIVE TO SPROCKET HOLE MEASURED AS TRUE POSITION OF POCKET, NOT POCKET HOLE
8. SURFACE RESISTIVITY
 $1 \times 10^4 - 1 \times 10^{11}$ OHMS/SQ;

A0=4.5±0.10
 B0=6.85±0.10
 K0=1.5±0.10

Recommended wave soldering condition

Product	Peak Temperature	Soldering Time
Pb-free devices	260 +0/-5 °C	5 +1/-1 seconds

Recommended temperature profile for IR reflow

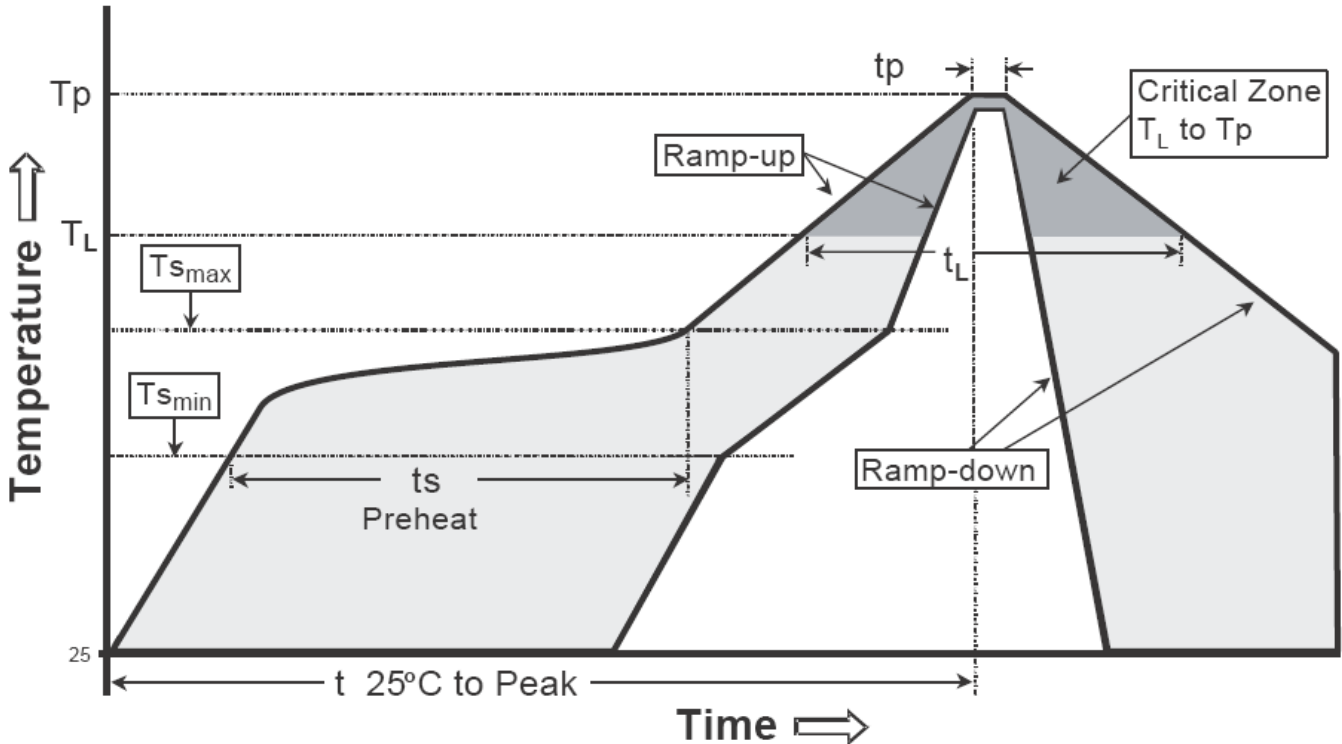

Profile feature	Sn-Pb eutectic Assembly	Pb-free Assembly
Average ramp-up rate (Tsmax to Tp)	3°C/second max.	3°C/second max.
Preheat		
-Temperature Min(Ts min)	100°C	150°C
-Temperature Max(Ts max)	150°C	200°C
-Time(ts min to ts max)	60-120 seconds	60-180 seconds
Time maintained above:		
-Temperature (T _L)	183°C	217°C
- Time (t _L)	60-150 seconds	60-150 seconds
Peak Temperature(T _P)	240 +0/-5 °C	260 +0/-5 °C
Time within 5°C of actual peak temperature(tp)	10-30 seconds	20-40 seconds
Ramp down rate	6°C/second max.	6°C/second max.
Time 25 °C to peak temperature	6 minutes max.	8 minutes max.

Note :1. All temperatures refer to topside of the package, measured on the package body surface.
 2. For devices mounted on FR-4 PCB of 1.6mm or equivalent grade PCB. If other grade PCB is used, care should be taken to match the coefficients of thermal expansion between components and PCB. If they are not matched well, the solder joints may crack or the bodies of the parts may crack or shatter as the assembly cools.

TO-277 Dimension

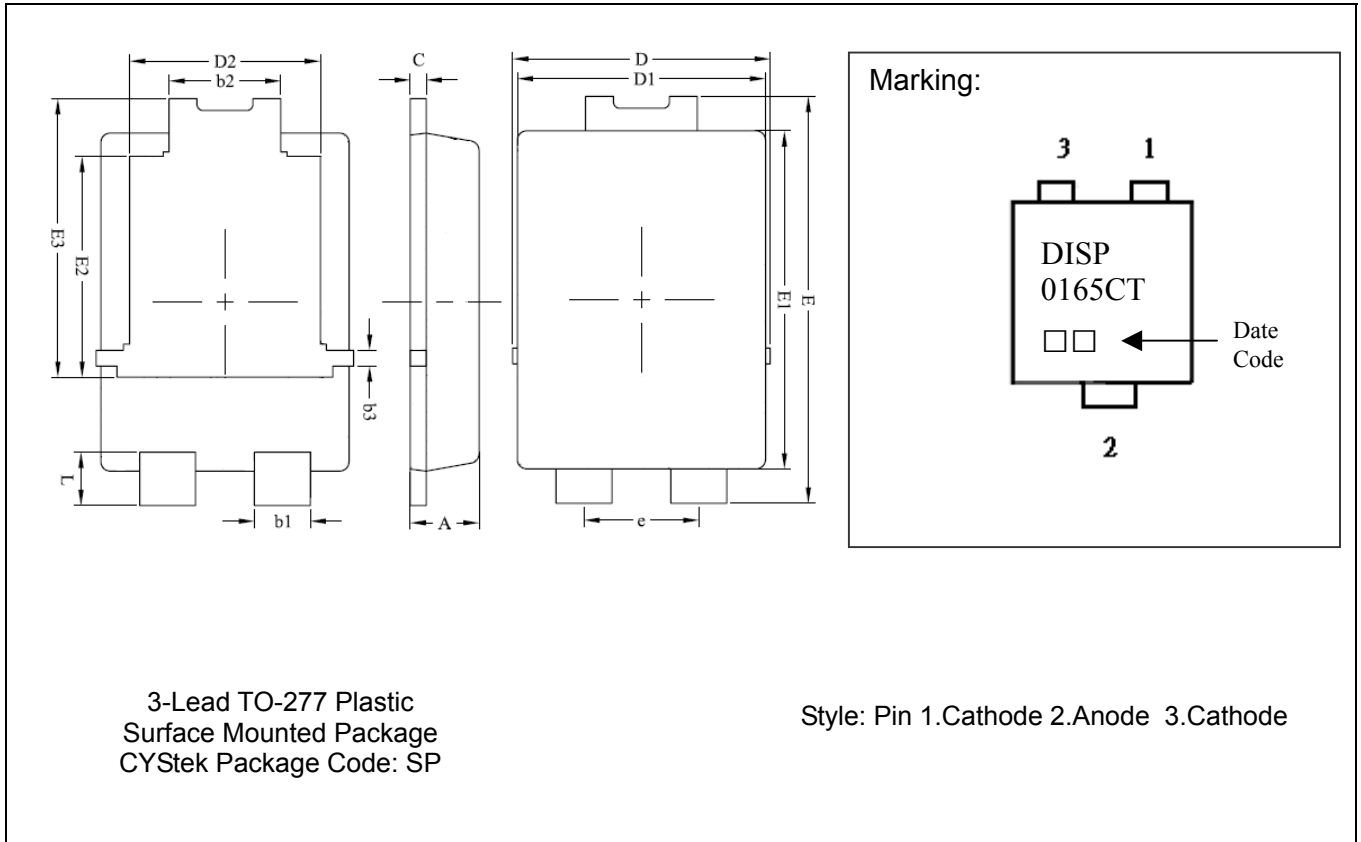

3-Lead TO-277 Plastic
 Surface Mounted Package
 CYStek Package Code: SP

Style: Pin 1.Cathode 2.Anode 3.Cathode

DIM	Millimeters		Inches		DIM	Millimeters		Inches	
	Min.	Max.	Min.	Max.		Min.	Max.	Min.	Max.
A	1.05	1.15	0.041	0.045	D2	2.95	3.15	0.116	0.124
b1	0.80	0.99	0.031	0.039	E	6.40	6.60	0.252	0.260
b2	1.70	1.88	0.067	0.074	E1	5.30	5.45	0.209	0.215
b3	0.15	0.35	0.006	0.014	E2	3.45	3.65	0.136	0.144
C	0.20	0.33	0.008	0.013	E3	4.20	4.60	0.165	0.181
D	4.00	4.30	0.157	0.169	e	1.84 TYP		0.072 TYP	
D1	3.90	4.05	0.154	0.159	L	0.75	0.95	0.030	0.037

Notes: 1.Controlling dimension : millimeters.
 2.Lead thickness specified per L/F drawing with solder plating.
 3.If there is any question with packing specification or packing method, please contact your local CYStek sales office.

Material:

- Lead: Pure tin plated.
- Mold Compound: Epoxy resin family, flammability solid burning class: UL94V-0.

Important Notice:

- All rights are reserved. Reproduction in whole or in part is prohibited without the prior written approval of CYStek.
- CYStek reserves the right to make changes to its products without notice.
- CYStek **semiconductor products are not warranted to be suitable for use in Life-Support Applications, or systems.**
- CYStek assumes no liability for any consequence of customer product design, infringement of patents, or application assistance.