

1A Switch Control Diode

DISC0165AF

Features

- High current capability
- Smoothly soft reverse recovery time (trr)
- Low profile surface mounted package in order to minimize board space
- Pb-free lead plating and halogen-free package

Mechanical data

- Case : Molded plastic, SMA-S/JEDEC DO-214AC
- Epoxy : UL94-V0 rated flame retardant
- Terminals : Plated terminals, solderable per MIL-STD-202 method 208
- Polarity : Indicated by cathode band
- Mounting position : Any
- Weight: 0.057 gram, 0.0017 ounce

Symbol

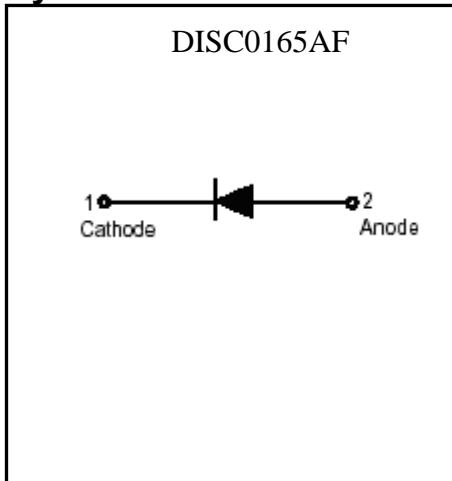

Outline

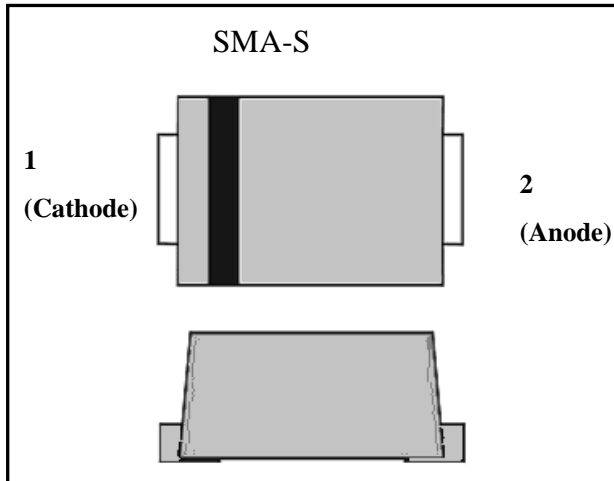

Ordering Information

Device	Package	Shipping
DISC0165AF-XX-T4-G	SMA-S (Pb-free lead plating and halogen-free package)	7500 pcs / tape & reel

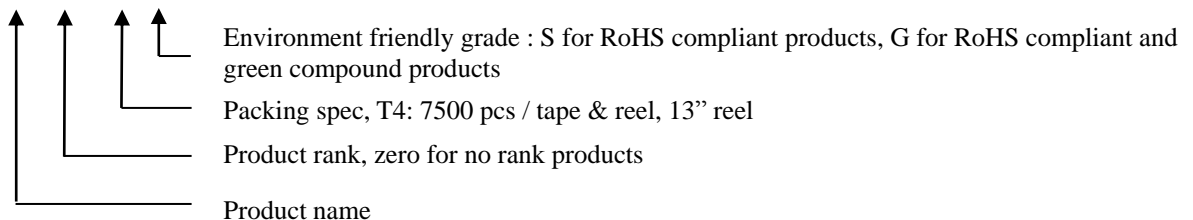



Absolute Maximum Ratings ($T_A=25^{\circ}\text{C}$, unless otherwise noted)

Parameters	Conditions	Symbol	Value		Units
			65	70	
Repetitive peak reverse voltage		V_{RRM}	650	690	V
RMS voltage		V_{RMS}	455	483	V
Continuous reverse voltage		V_R	650	690	V
Forward rectified current	Single phase half wave, 60Hz @ $T_J=25^{\circ}\text{C}$	$I_{F(AV)}$	1		A
Repetitive Peak Forward Current	Single phase half wave, 60Hz @ $T_J=25^{\circ}\text{C}$	I_{FRM}	1.57		A
Forward surge current	8.3ms single half sine-wave superimposed on rated load (JEDEC method)	I_{FSM}	10		A
	$t_p \leq 1\mu\text{s}$		20		
Maximum reverse recovery time	$I_F=1\text{A}$, $dI_F/dt=100\text{A}/\mu\text{s}$	t_{rr}	1.5		μs
Power Dissipation	$T_A=25^{\circ}\text{C}$ (Note)	P_D	1.3		W
	$T_A=70^{\circ}\text{C}$ (Note)		0.83		
	$T_C=25^{\circ}\text{C}$		6.2		
	$T_C=100^{\circ}\text{C}$		2.5		
Storage temperature range		T_{stg}	-55~+150		$^{\circ}\text{C}$
Operating junction temperature range		T_j	-55~+150		$^{\circ}\text{C}$

Thermal Data

Parameter	Symbol	Value	Unit
Thermal Resistance, Junction-to-case, max	$R_{th,j-c}$	20	$^{\circ}\text{C}/\text{W}$
Thermal Resistance, Junction-to-ambient, max (Note)	$R_{th,j-a}$	95	

Note : Mounted on PCB with 10mmx10mm copper pad area.

Characteristics ($T_A=25^{\circ}\text{C}$, unless otherwise noted)

Characteristic	Symbol	Condition	Min.	Typ	Max.	Unit
Continuous reverse voltage	V_R	$I_R=100\mu\text{A}$	650	-	-	V
Forward Voltage	$V_F 1$	$I_F=100\text{mA}$	-	-	0.95	V
	$V_F 2$	$I_F=500\text{mA}$	-	-	1.2	
Reverse Leakage Current	I_R	$V_R=600\text{V}$	-	-	100	nA
		$V_R=540\text{V}$, $T_A=125^{\circ}\text{C}$	-	-	10	μA
Junction Capacitance	C_J	$V_R=1\text{V}$, $f=1\text{MHz}$	-	6	-	pF

Classification by V_R

Rank	65	70
Spec	$V_R>650\text{V}$	$V_R>690\text{V}$



Typical Characteristics

Power Derating Curve

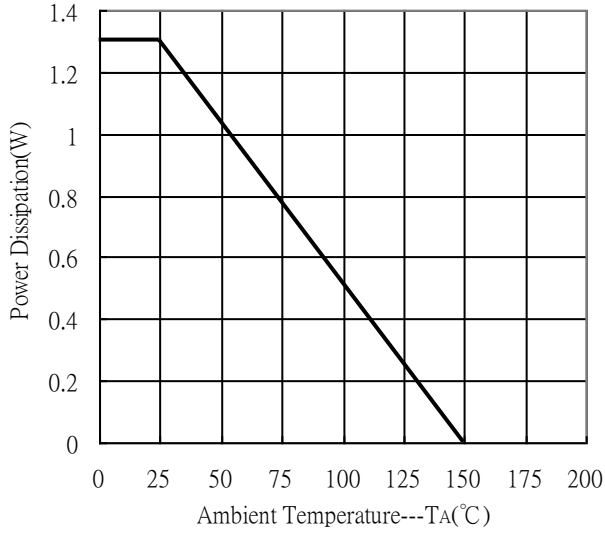

Power Derating Curve

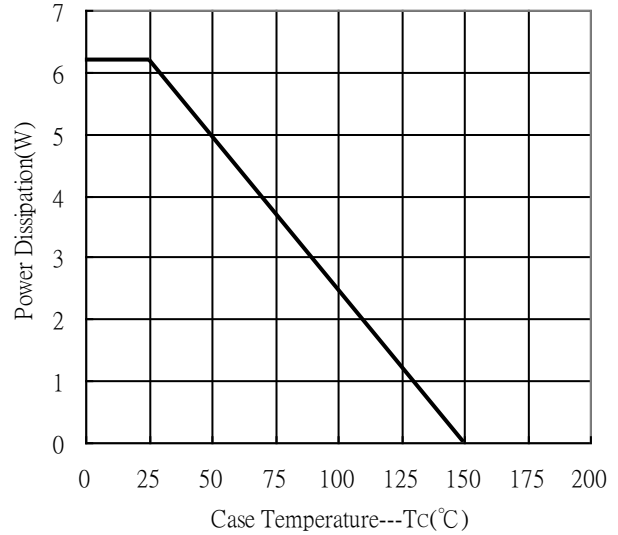

Forward Current vs Forward Voltage

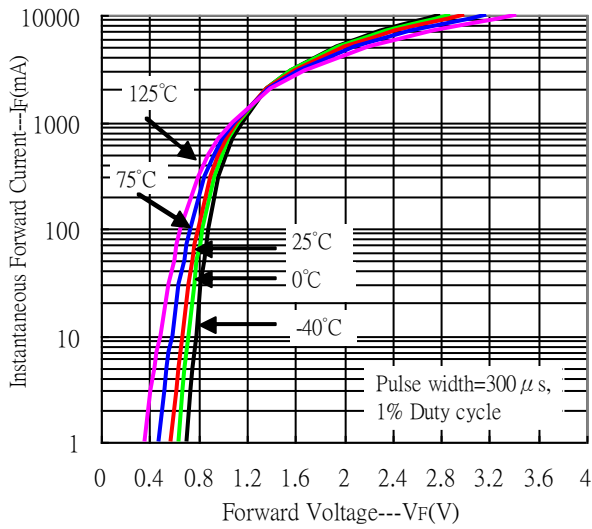

Reverse Leakage Current vs Reverse Voltage

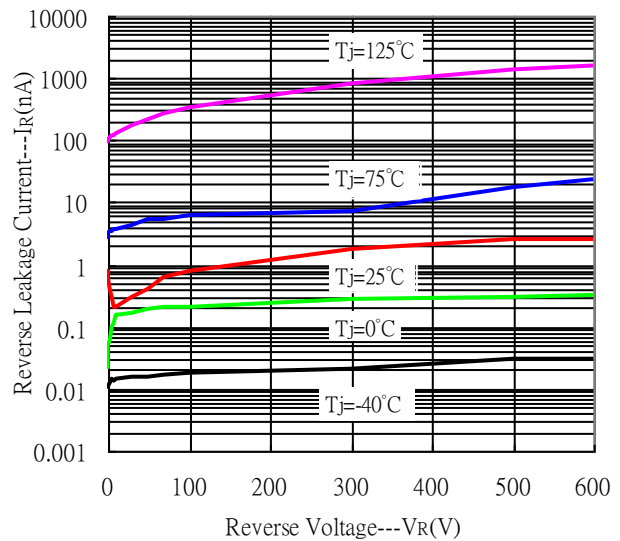

Junction Capacitance vs Reverse Voltage

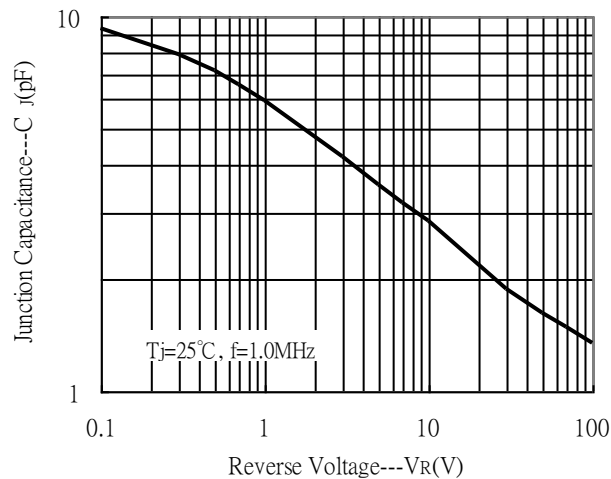

Recommended Footprint

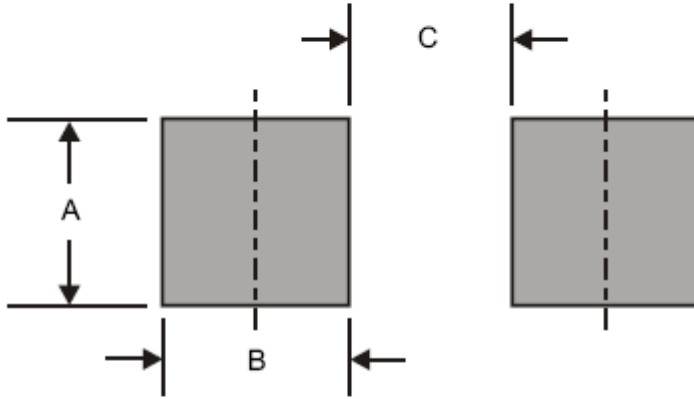

Dimensions in inches and (millimeters)

DIM	Inches	Millimeters
	Typ	Typ
A	0.075	1.90
B	0.055	1.40
C	0.075	1.90

Taping Reel Dimension

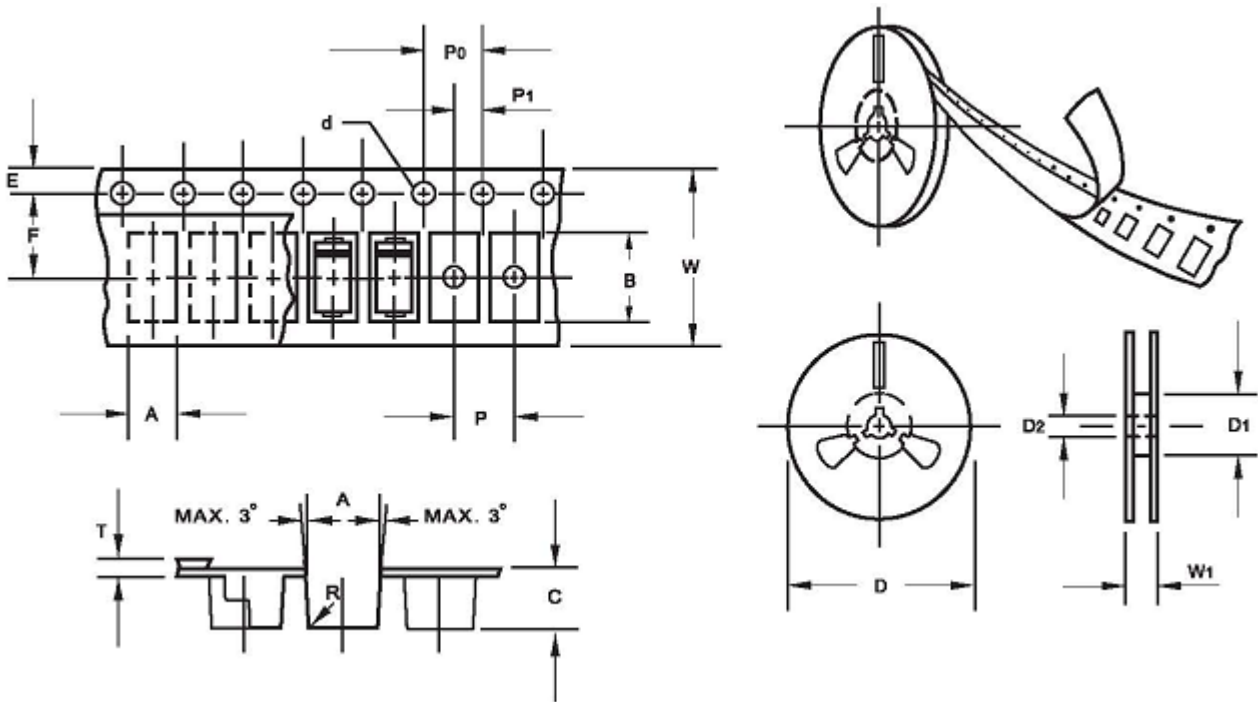

unit : mm

Item	Tolerance	Symbol	
Carrier width	0.10	A	2.90
Carrier length	0.10	B	5.50
Carrier depth	0.10	C	2.10
Sprocket hole	0.10	d	1.50
13" Reel outside diameter	2.00	D	330.00
13" Reel inner diameter	min.	D1	50.00
7" Reel outside diameter	2.00	D	178.00
7" Reel inner diameter	min.	D1	62.00
Feed hole diameter	0.50	D2	13.00
Sprocket hole position	0.10	E	1.75
Punch hole position	0.10	F	5.50
Punch hole pitch	0.10	P	4.00
Sprocket hole pitch	0.10	P0	4.00
Embossment center	0.10	P1	2.00
Tape width	0.30	W	12.00
Reel width	1.00	W1	18.00

NOTE: Devices are packed in accordance with EIA standard RS-481-A and specification given above

Recommended wave soldering condition

Product	Peak Temperature	Soldering Time
Pb-free devices	260 +0/-5 °C	5 +1/-1 seconds

Recommended temperature profile for IR reflow

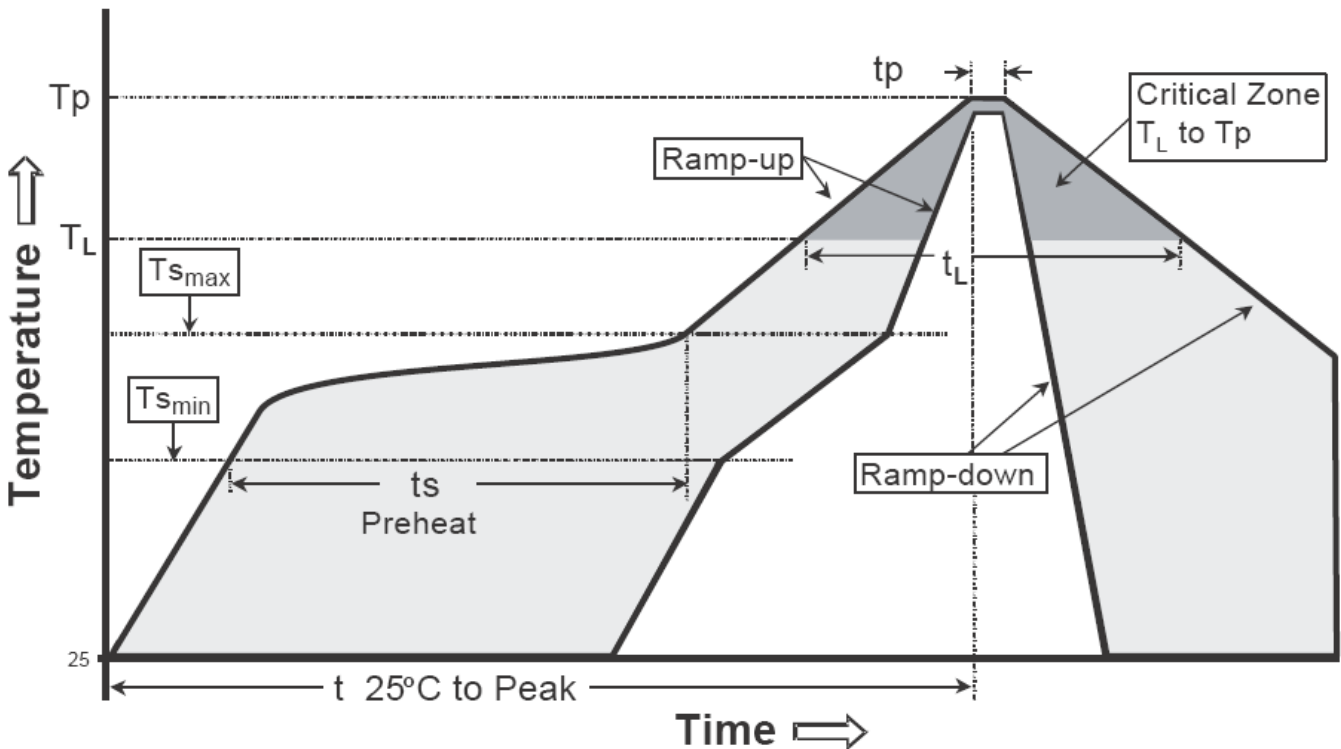

Profile feature	Sn-Pb eutectic Assembly	Pb-free Assembly
Average ramp-up rate (Tsmax to Tp)	3°C/second max.	3°C/second max.
Preheat		
-Temperature Min(Ts min)	100°C	150°C
-Temperature Max(Ts max)	150°C	200°C
-Time(ts min to ts max)	60-120 seconds	60-180 seconds
Time maintained above:		
-Temperature (Tl)	183°C	217°C
- Time (tl)	60-150 seconds	60-150 seconds
Peak Temperature(Tp)	240 +0/-5 °C	260 +0/-5 °C
Time within 5°C of actual peak temperature(tp)	10-30 seconds	20-40 seconds
Ramp down rate	6°C/second max.	6°C/second max.
Time 25 °C to peak temperature	6 minutes max.	8 minutes max.

Note : All temperatures refer to topside of the package, measured on the package body surface.

SMA-S/DO-214AC Dimension

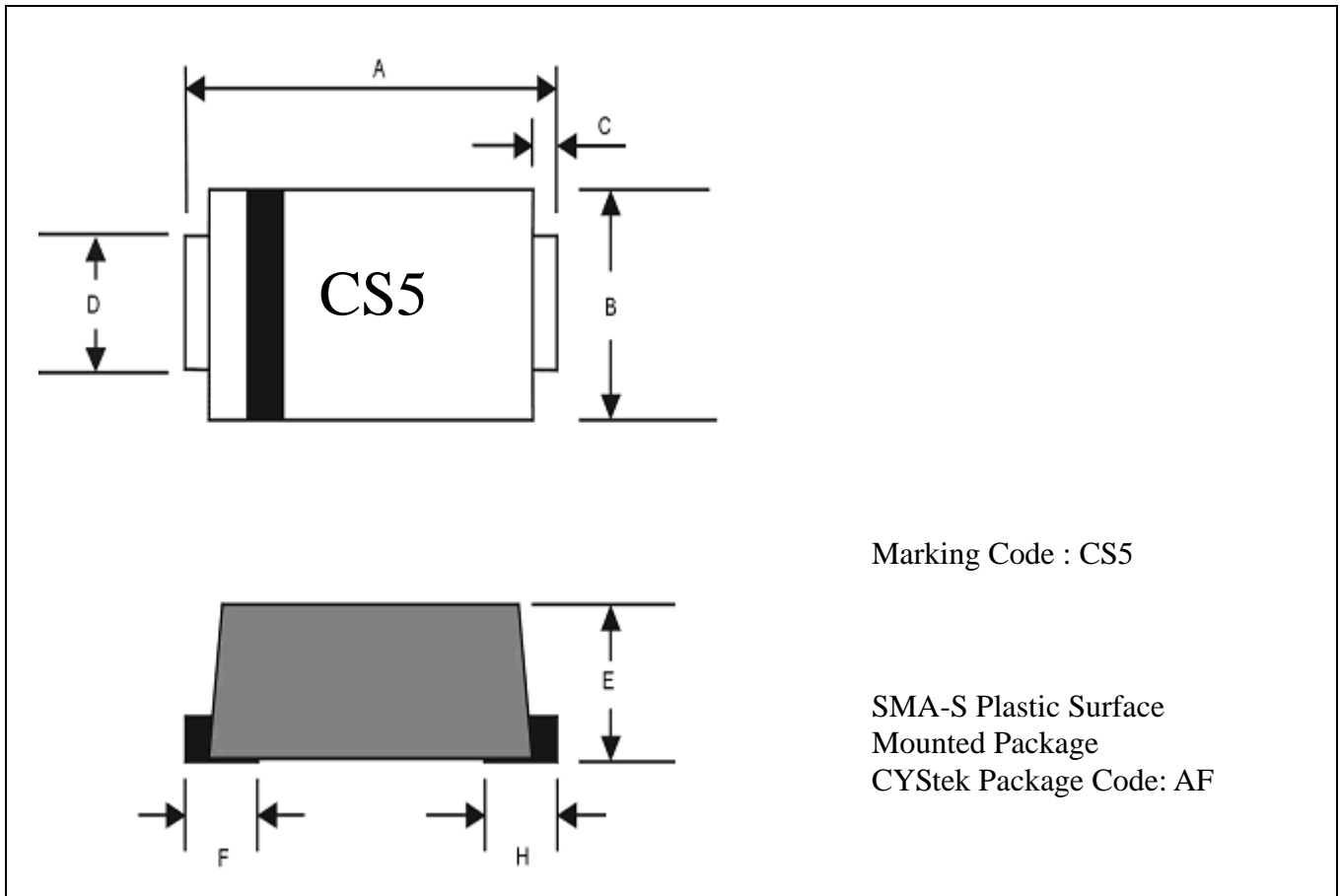

*:Typical

DIM	Inches		Millimeters		DIM	Inches		Millimeters	
	Min.	Max.	Min.	Max.		Min.	Max.	Min.	Max.
A	0.197	0.213	5.0	5.4	E	0.060	0.071	1.5	1.8
B	0.091	0.106	2.3	2.7	F	0.040*		1.0*	
C	0.012*		0.3*		H	0.040*		1.0*	
D	0.055	0.063	1.4	1.6	-	-	-	-	-

Notes : 1.Controlling dimension : millimeters.
 2.Maximum lead thickness includes lead finish thickness, and minimum lead thickness is the minimum thickness of base material.
 3.If there is any question with packing specification or packing method, please contact your local CYStek sales office.

Material :

- Lead : Pure tin plated.
- Mold Compound : Epoxy resin family, flammability solid burning class:UL94V-0.

Important Notice:

- All rights are reserved. Reproduction in whole or in part is prohibited without the prior written approval of CYStek.
- CYStek reserves the right to make changes to its products without notice.
- CYStek **semiconductor products are not warranted to be suitable for use in Life-Support Applications, or systems.**
- CYStek assumes no liability for any consequence of customer product design, infringement of patents, or application assistance.