

Low Vcesat NPN Epitaxial Planar Transistor

BTD2150A3

BV_{CEO}	50V
I_C	3A
$R_{CESAT} (Typ)$	125m Ω

Features

- Low $V_{CE(sat)}$, typically 0.25V at $I_C / I_B = 2A / 100mA$
0.1V at $I_C / I_B = 1A / 50mA$
- Excellent current gain characteristics
- Complementary to BTB1424A3
- Pb-free lead plating and halogen-free package

Symbol

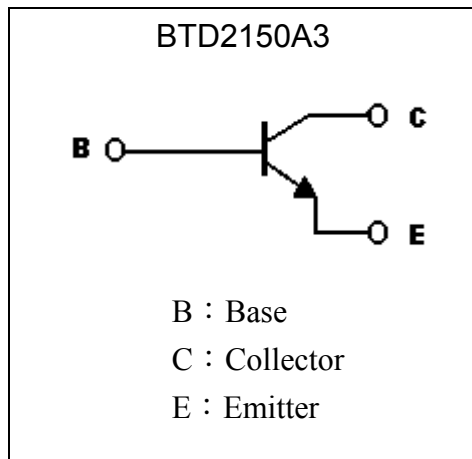

Outline

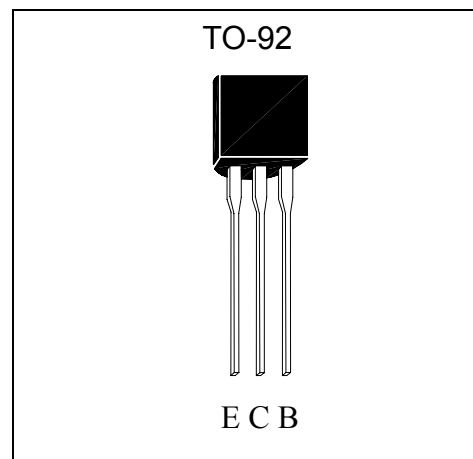

Ordering Information

Device	Package	Shipping
BTD2150A3-X-TB-G	TO-92 (Pb-free lead plating and halogen-free package)	2000 pcs / Tape & Box
BTD2150A3-X-BK-G	TO-92 (Pb-free lead plating and halogen-free package)	1000 pcs/ bag, 10 bags/box, 10boxes/carton

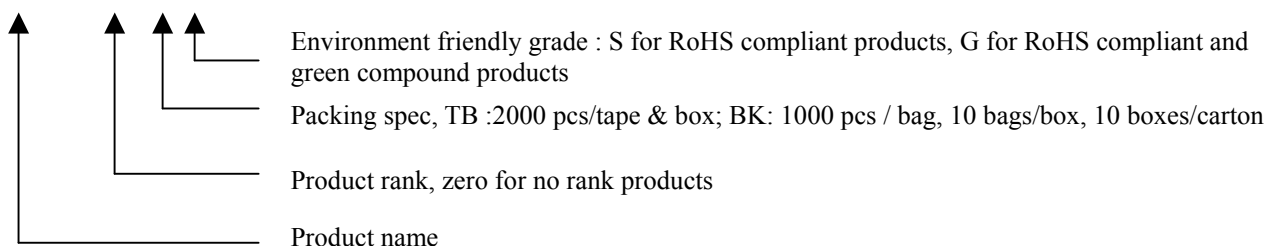

**Absolute Maximum Ratings** (Ta=25°C)

Parameter	Symbol	Limit	Unit
Collector-Base Voltage	V _{CBO}	80	V
Collector-Emitter Voltage	V _{CEO}	50	V
Emitter-Base Voltage	V _{EBO}	6	V
Collector Current	I _{C(DC)}	3	A
	I _{C(Pulse)}	7 (Note)	A
Power Dissipation	P _d	750	mW
Junction Temperature	T _j	150	°C
Storage Temperature	T _{stg}	-55~+150	°C

Note : *1. Single Pulse P_w ≤ 350μs, Duty ≤ 2%.**Characteristics** (Ta=25°C)

Symbol	Min.	Typ.	Max.	Unit	Test Conditions
BV _{CBO}	80	-	-	V	I _C =50μA, I _E =0
BV _{CEO}	50	-	-	V	I _C =1mA, I _B =0
BV _{EBO}	6	-	-	V	I _E =50μA, I _C =0
I _{CBO}	-	-	100	nA	V _{CB} =60V, I _E =0
I _{EBO}	-	-	100	nA	V _{EB} =5V, I _C =0
*V _{CE(sat)}	-	0.1	0.25	V	I _C =1A, I _B =50mA
*V _{CE(sat)}	-	0.25	0.5	V	I _C =2A, I _B =100mA
*V _{BE(sat)}	-	-	1.5	V	I _C =2A, I _B =200mA
*h _{FE1}	180	-	-	-	V _{CE} =2V, I _C =100mA
*h _{FE2}	180	-	820	-	V _{CE} =2V, I _C =500mA
*h _{FE3}	150	-	-	-	V _{CE} =2V, I _C =1A
f _T	-	90	-	MHz	V _{CE} =5V, I _C =100mA, f=100MHz
C _{ob}	-	13	-	pF	V _{CB} =10V, f=1MHz

*Pulse Test : Pulse Width ≤ 380μs, Duty Cycles ≤ 2%

Classification Of h_{FE} 2

Rank	R	S	T
Range	180~390	270~560	390~820

Typical Characteristics

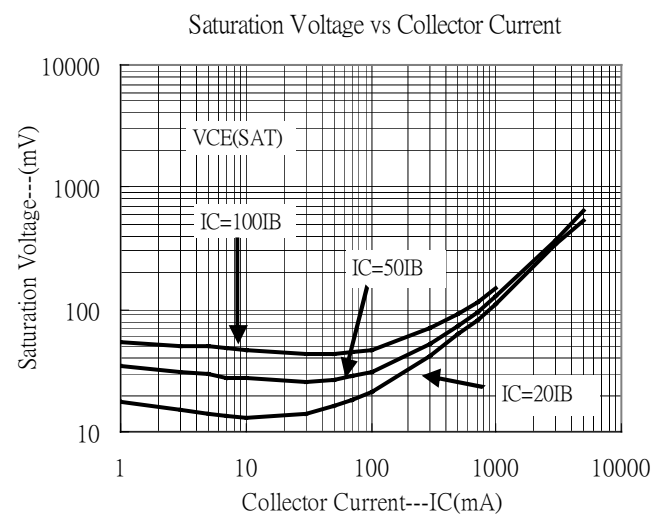
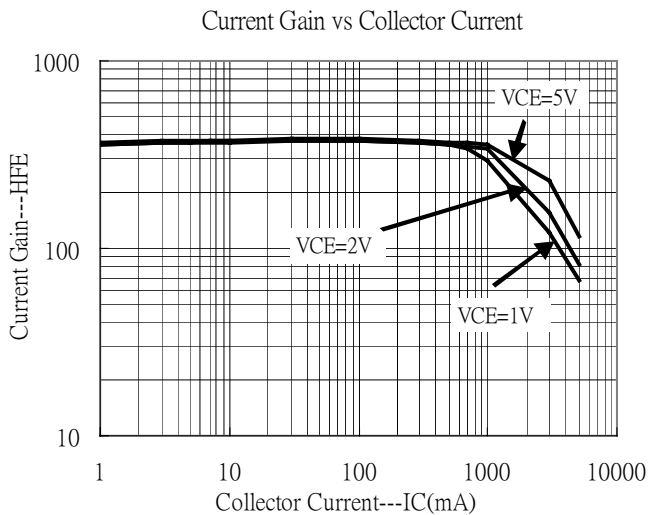
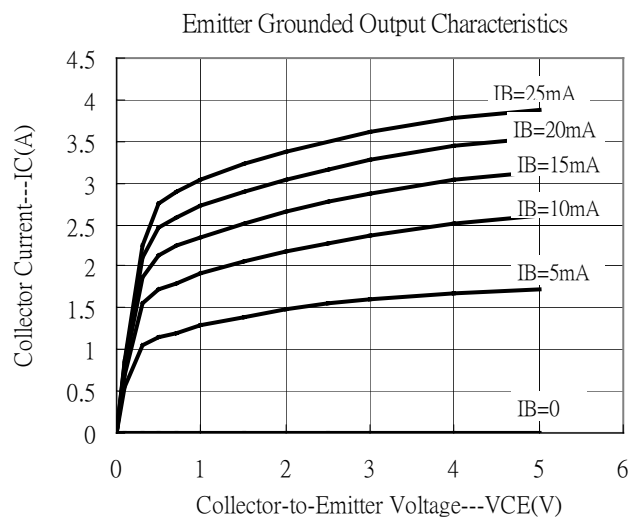
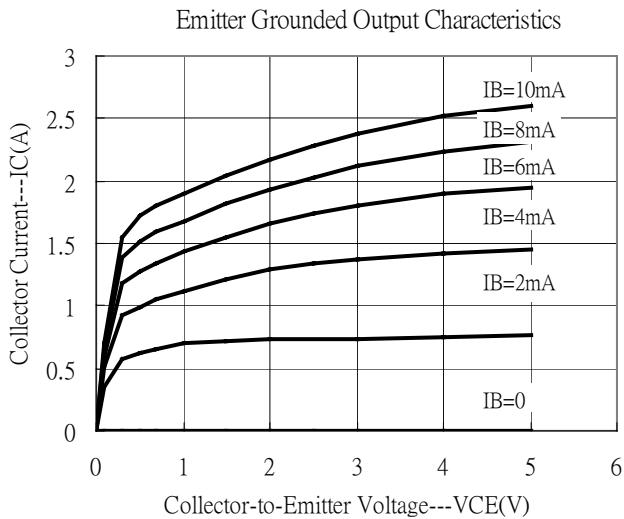
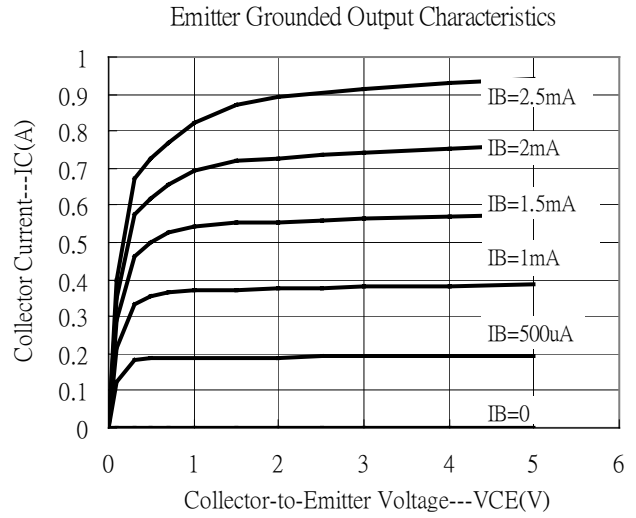
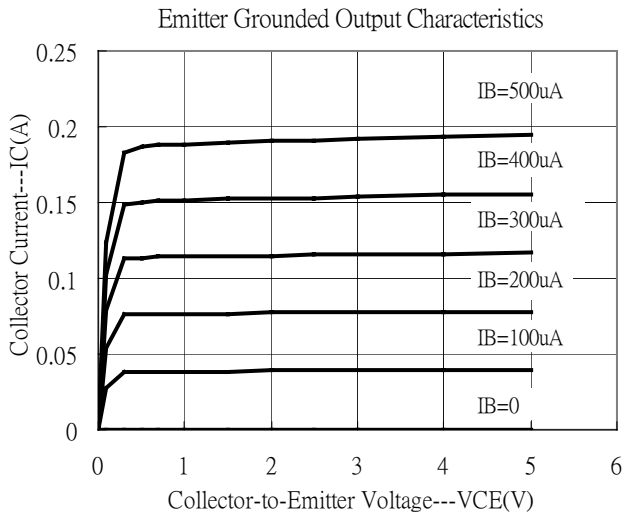

Characteristic Curves(Cont.)

Saturation Voltage vs Collector Current

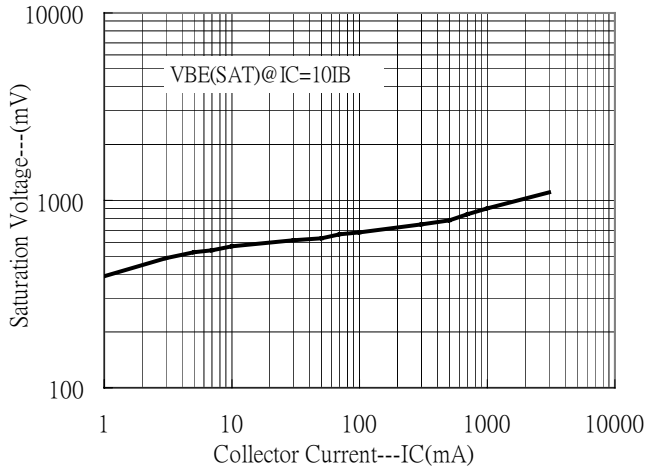

Capacitance vs Reverse-Biased Voltage

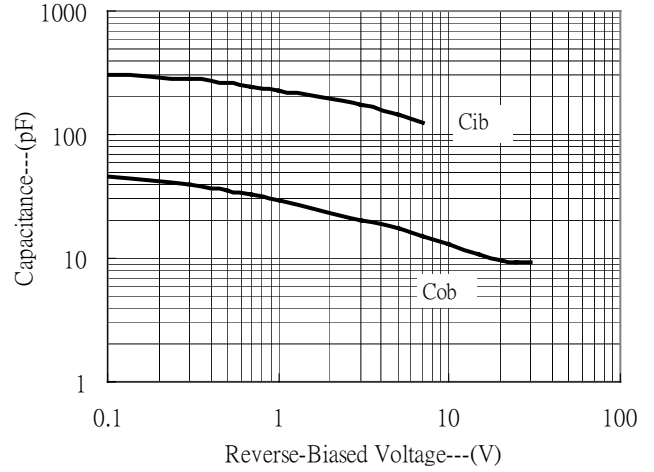

Power Derating Curve

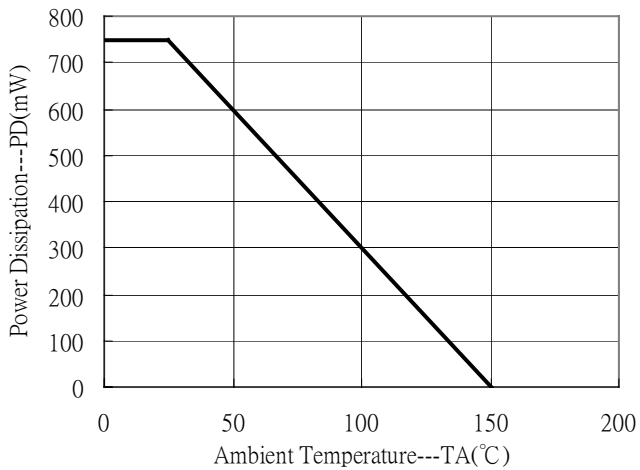

TO-92 Taping Outline

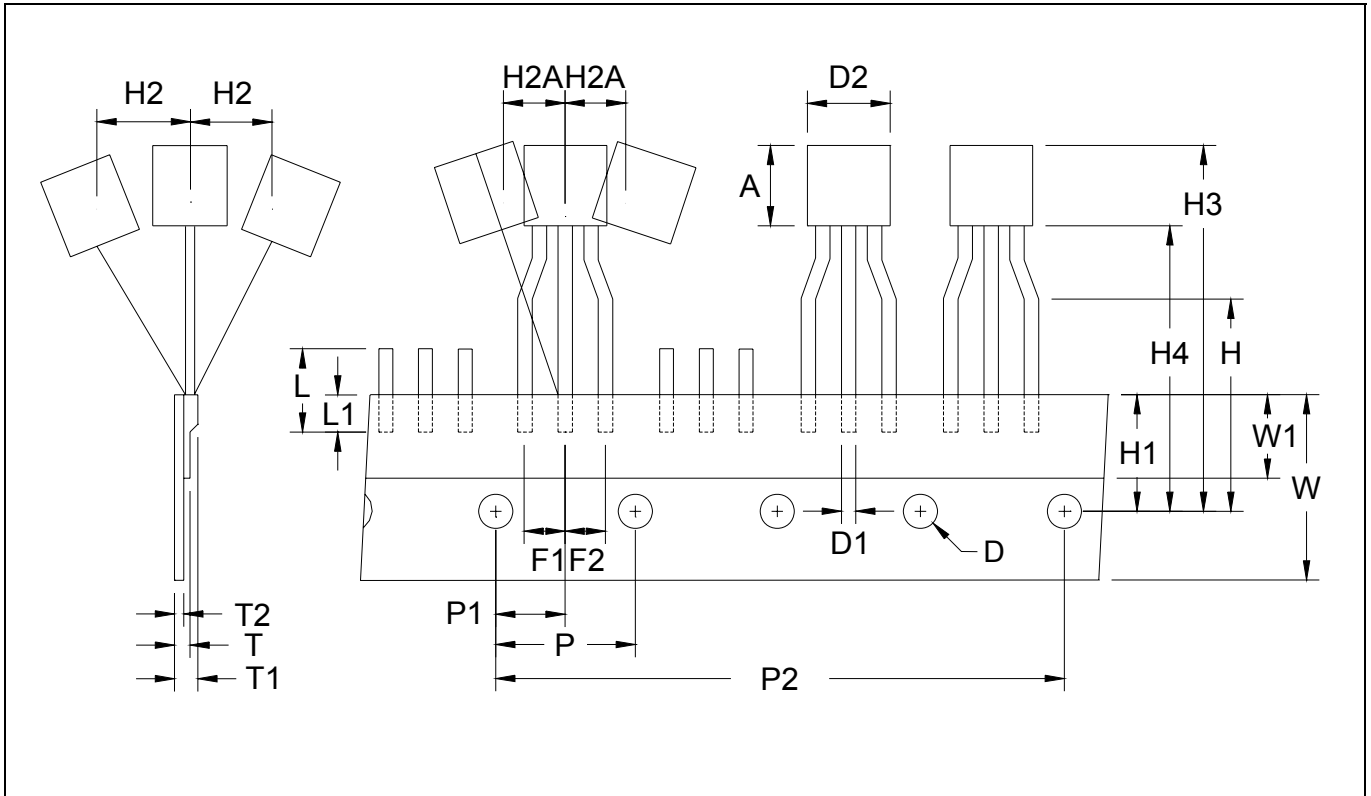

DIM	Item	Millimeters	
		Min.	Max.
A	Component body height	4.33	4.83
D	Tape Feed Diameter	3.80	4.20
D1	Lead Diameter	0.36	0.53
D2	Component Body Diameter	4.33	4.83
F1,F2	Component Lead Pitch	2.40	2.90
F1,F2	F1-F2	-	±0.3
H	Height Of Seating Plane	15.50	16.50
H1	Feed Hole Location	8.50	9.50
H2	Front To Rear Deflection	-	1
H2A	Deflection Left Or Right	-	1
H3	Component Height	-	27
H4	Feed Hole To Bottom Of Component	-	21
L	Lead Length After Component Removal	-	11
L1	Lead Wire Enclosure	2.50	-
P	Feed Hole Pitch	12.50	12.90
P1	Center Of Seating Plane Location	5.95	6.75
P2	4 Feed Hole Pitch	50.30	51.30
T	Over All Tape Thickness	-	0.55
T1	Total Taped Package Thickness	-	1.42
T2	Carrier Tape Thickness	0.36	0.68
W	Tape Width	17.50	19.00
W1	Adhesive Tape Width	5.00	7.00
-	20 pcs Pitch	253	255

Recommended wave soldering condition

Product	Peak Temperature	Soldering Time
Pb-free devices	260 +0/-5 °C	5 +1/-1 seconds

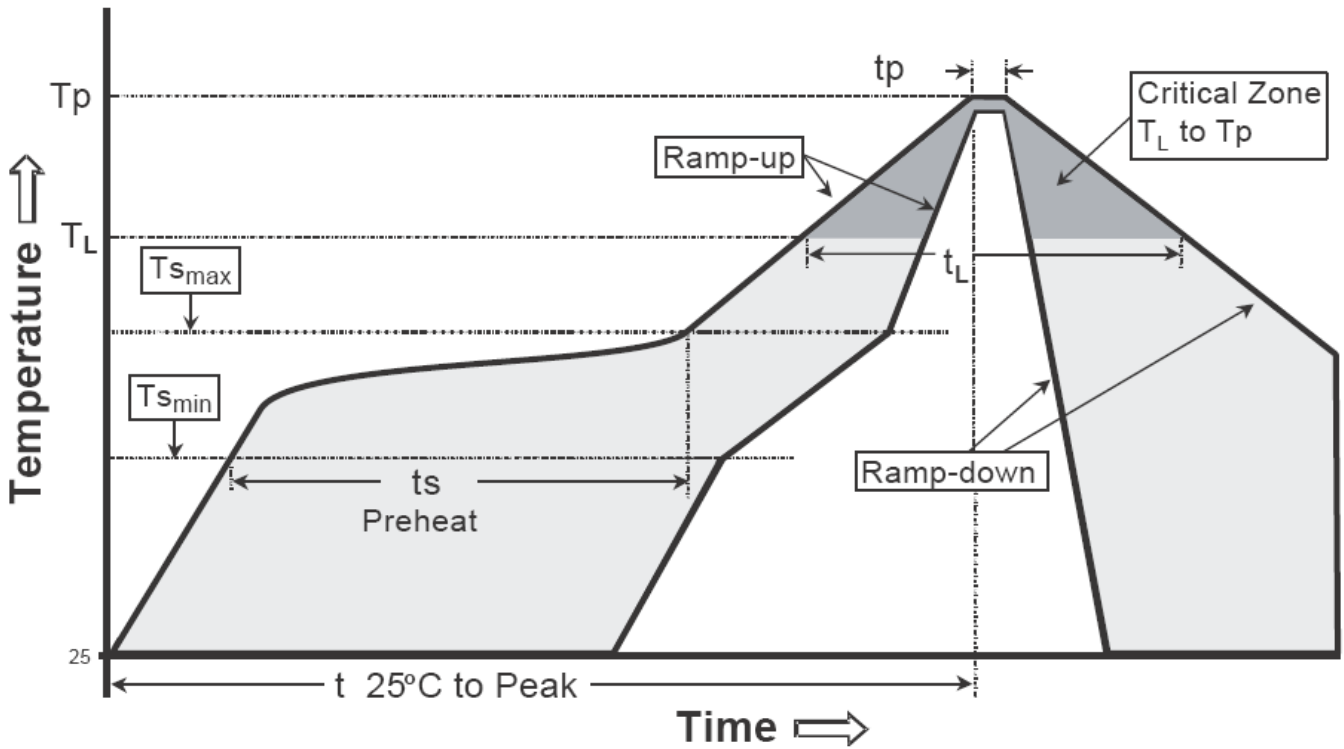
Recommended temperature profile for IR reflow

Profile feature	Sn-Pb eutectic Assembly	Pb-free Assembly
Average ramp-up rate (T _{smax} to T _p)	3°C/second max.	3°C/second max.
Preheat		
-Temperature Min(T _{s min})	100°C	150°C
-Temperature Max(T _{s max})	150°C	200°C
-Time(t _{s min} to t _{s max})	60-120 seconds	60-180 seconds
Time maintained above:		
-Temperature (T _L)	183°C	217°C
- Time (t _L)	60-150 seconds	60-150 seconds
Peak Temperature(T _P)	240 +0/-5 °C	260 +0/-5 °C
Time within 5°C of actual peak temperature(tp)	10-30 seconds	20-40 seconds
Ramp down rate	6°C/second max.	6°C/second max.
Time 25 °C to peak temperature	6 minutes max.	8 minutes max.

Note : All temperatures refer to topside of the package, measured on the package body surface.

TO-92 Dimension

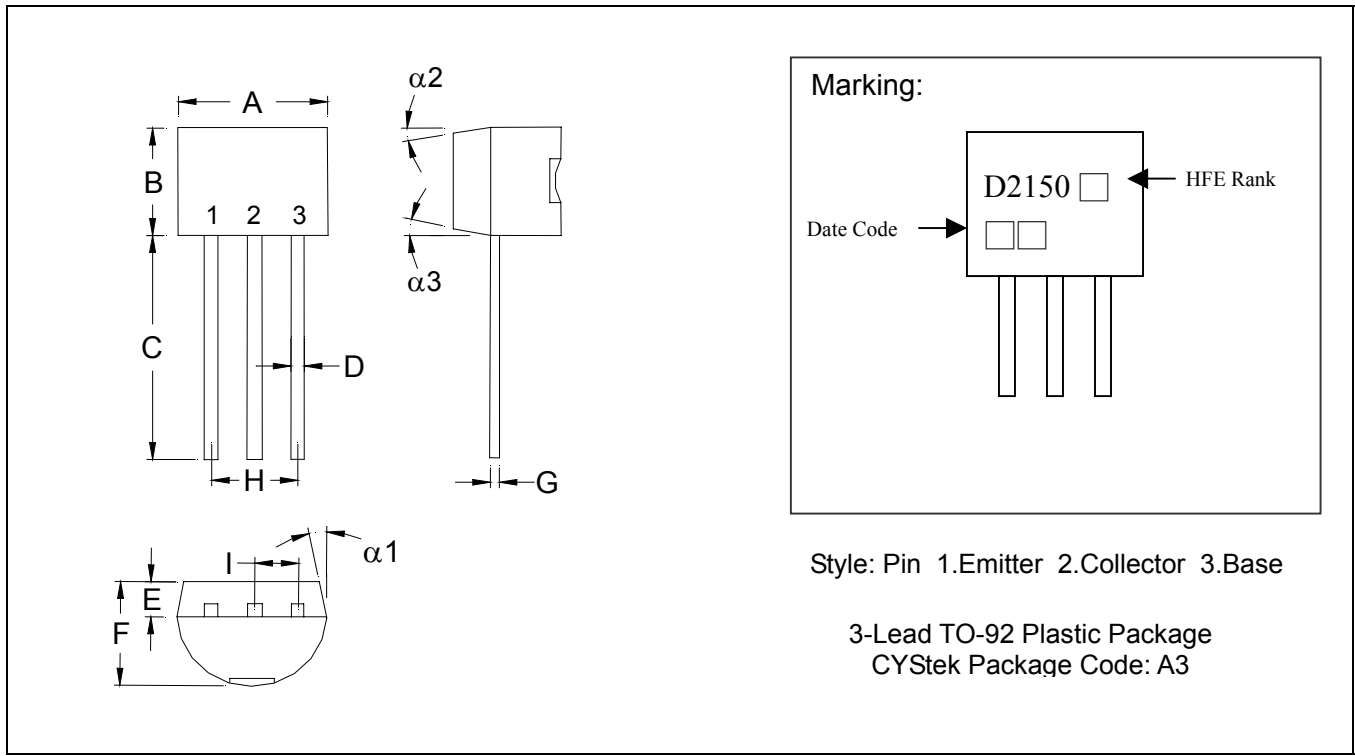

*: Typical

DIM	Inches		Millimeters		DIM	Inches		Millimeters	
	Min.	Max.	Min.	Max.		Min.	Max.	Min.	Max.
A	0.1704	0.1902	4.33	4.83	G	0.0142	0.0220	0.36	0.56
B	0.1704	0.1902	4.33	4.83	H	-	*0.1000	-	*2.54
C	0.5000	-	12.70	-	I	-	*0.0500	-	*1.27
D	0.0142	0.0220	0.36	0.56	$\alpha 1$	-	*5°	-	*5°
E	-	*0.0500	-	*1.27	$\alpha 2$	-	*2°	-	*2°
F	0.1323	0.1480	3.36	3.76	$\alpha 3$	-	*2°	-	*2°

Notes: 1. Controlling dimension: millimeters.
 2. Maximum lead thickness includes lead finish thickness, and minimum lead thickness is the minimum thickness of base material.
 3. If there is any question with packing specification or packing method, please contact your local CYStek sales office.

Material:

- Lead: Pure tin plated.
- Mold Compound: Epoxy resin family, flammability solid burning class: UL94V-0.

Important Notice:

- All rights are reserved. Reproduction in whole or in part is prohibited without the prior written approval of CYStek.
- CYStek reserves the right to make changes to its products without notice.
- CYStek **semiconductor products are not warranted to be suitable for use in Life-Support Applications, or systems.**
- CYStek assumes no liability for any consequence of customer product design, infringement of patents, or application assistance.