

**Microwave Low Noise Amplifier
 NPN Silicon Epitaxial Planar Transistor**

BTC3356N3

Description

- The BTC3356N3 is a NPN silicon epitaxial transistor designed for low noise amplifier at VHF, UHF and CATV band.
- Low Cre. Typ. Cob=0.6pF
- Pb-free and halogen-free package

Symbol

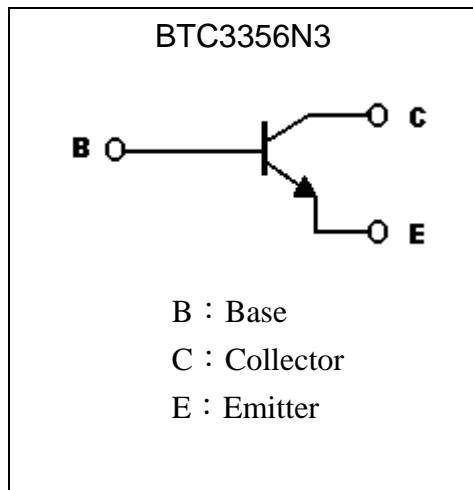

Outline

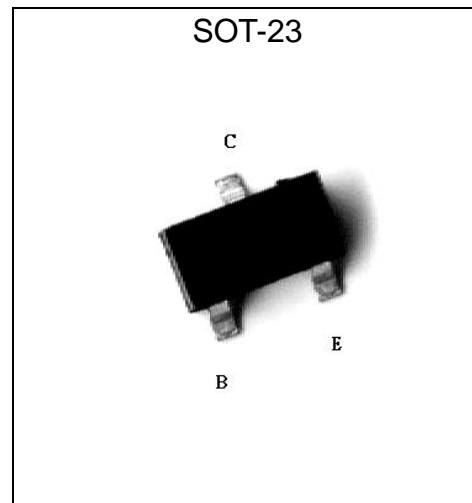

Ordering Information

Device	Package	Shipping
BTC3356N3-X-T1-G	SOT-23 (Pb-free lead plating and halogen-free package)	3000 pcs / Tape & Reel

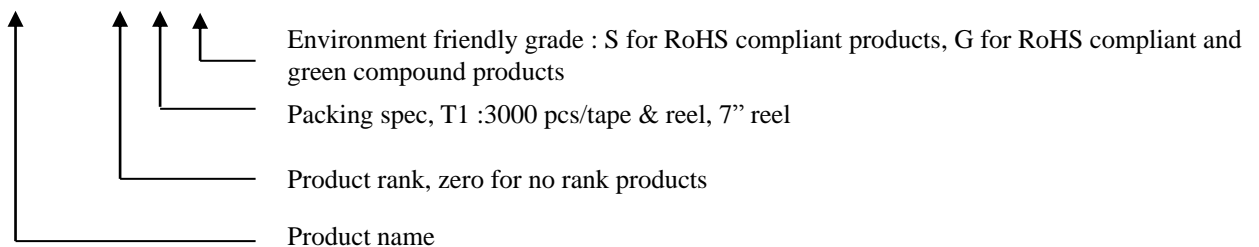



Absolute Maximum Ratings (Ta=25°C)

Parameter	Symbol	Limits	Unit
Collector-Base Voltage	V _{CB0}	20	V
Collector-Emitter Voltage	V _{CEO}	11	V
Emitter-Base Voltage	V _{EBO}	3	V
Collector Current	I _C	100	mA
Power Dissipation	P _d	225	mW
Thermal Resistance, Junction to Ambient	R _{θJA}	556	°C/W
Operating Junction Temperature Range	T _j	-55~+150	°C
Storage Temperature Range	T _{stg}	-55~+150	°C

Characteristics (Ta=25°C)

Symbol	Min.	Typ.	Max.	Unit	Test Conditions
BV _{CB0}	20	-	-	V	I _C =100μA
BV _{CEO}	11	-	-	V	I _C =1mA
BV _{EBO}	3	-	-	V	I _E =10μA
I _{CB0}	-	-	100	nA	V _{CB} =20V
I _{EBO}	-	-	100	nA	V _{EB} =2V
*V _{CE(sat)}	-	-	150	mV	I _C =10mA, I _B =1mA
*V _{BE(sat)}	-	-	1.2	V	I _C =10mA, I _B =1mA
*V _{BE(ON)}	0.7	0.82	0.95	V	V _{CE} =3V, I _C =10mA
*h _{FE}	80	-	250		V _{CE} =10V, I _C =20mA
S _{21e} ²	-	11.5	-	dB	V _{CE} =10V, I _C =20mA, f=1GHz
f _T	-	6.5	-	GHz	V _{CE} =10V, I _C =20mA, f=1GHz
C _{re}	-	0.6	1	pF	V _{CB} =10V, f=1MHz

*Pulse Test: Pulse Width ≤380us, Duty Cycle≤2%

Classification Of h_{FE}

Rank	R	S
Range	80~160	125~250



Typical Characteristics

Emitter Grounded Output Characteristics

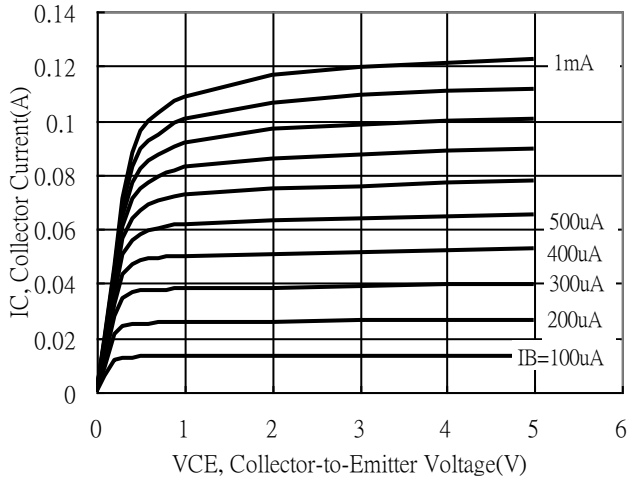

Emitter Grounded Output Characteristics

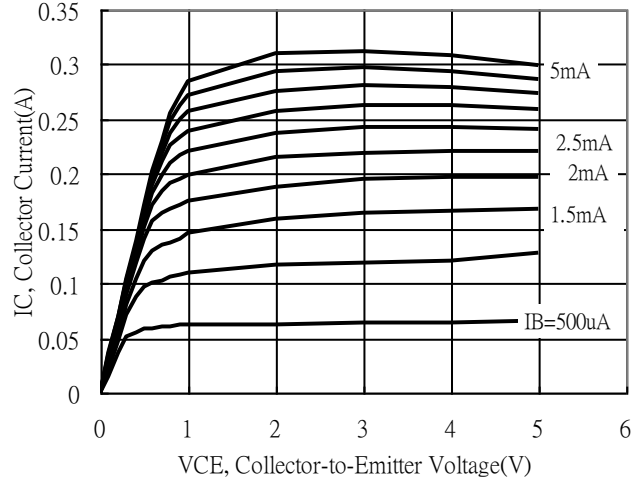

Current Gain vs Collector Current

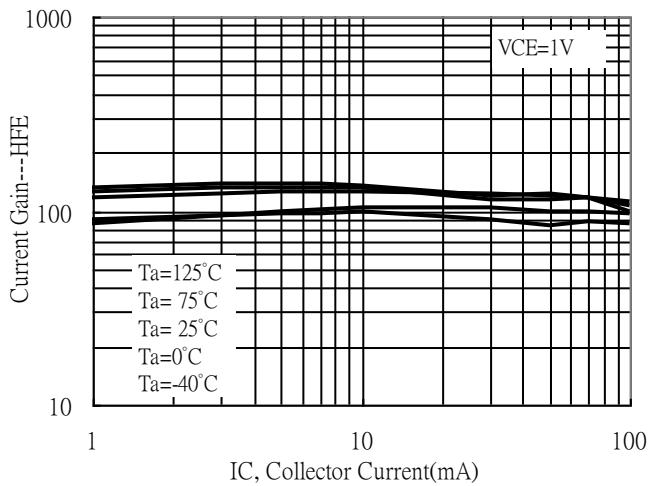

Current Gain vs Collector Current

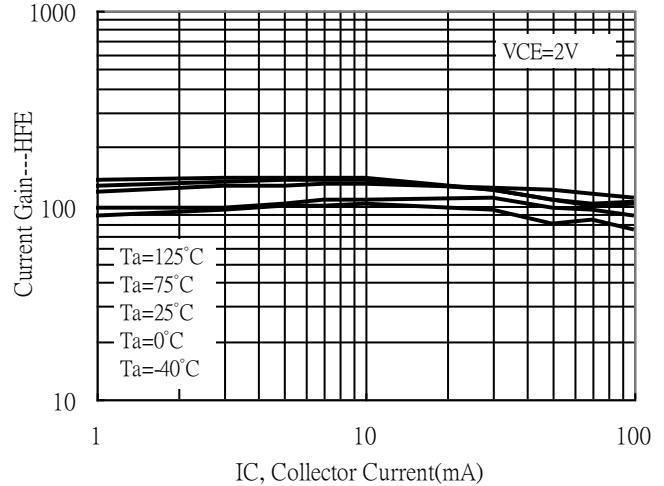

Current Gain vs Collector Current

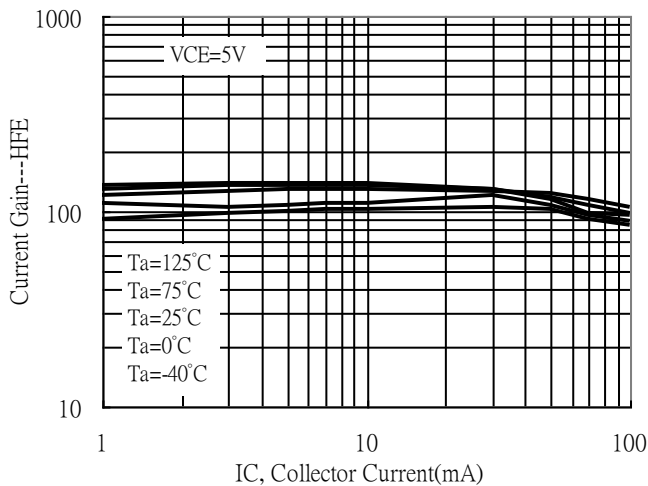

Current Gain vs Collector Current

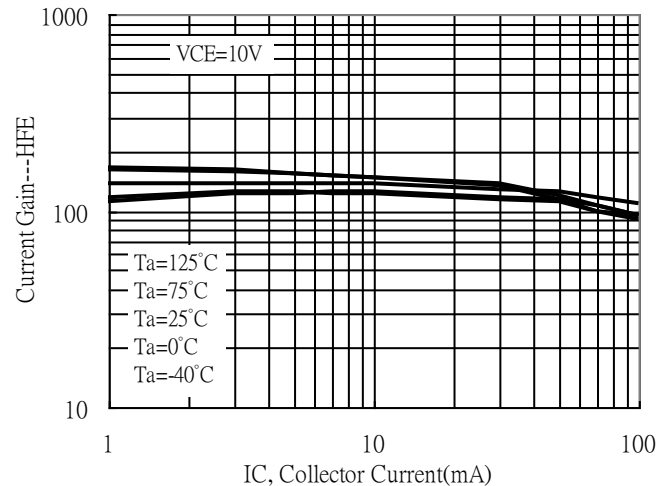

Typical Characteristics(Cont.)

Saturation Voltage vs Collector Current

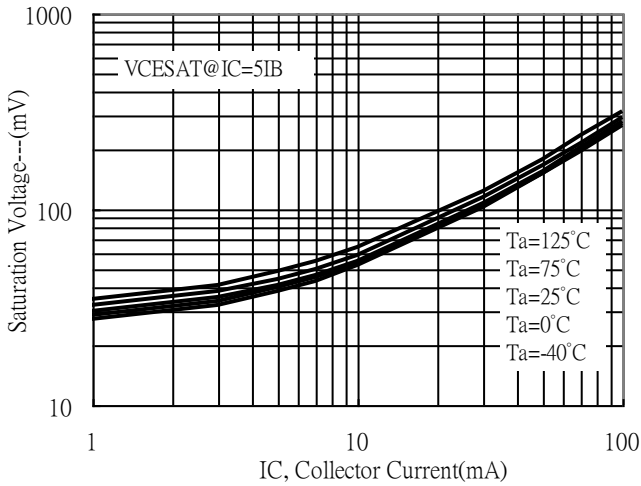

Saturation Voltage vs Collector Current

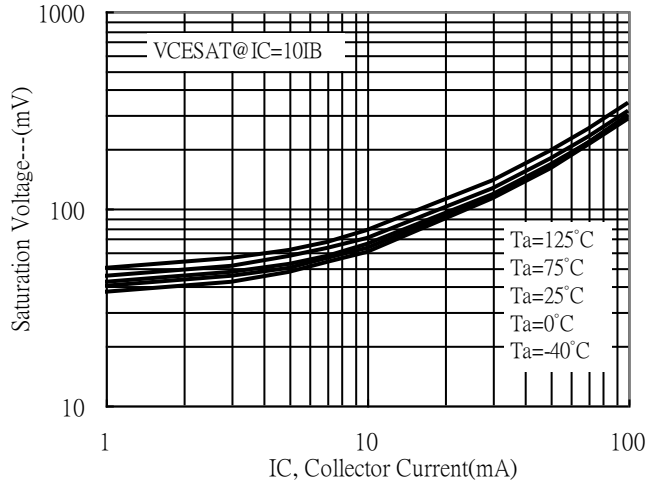

Saturation Voltage vs Collector Current

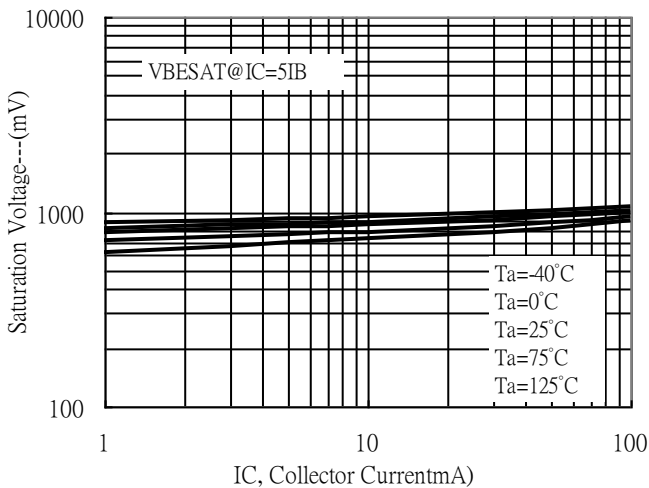

Saturation Voltage vs Collector Current

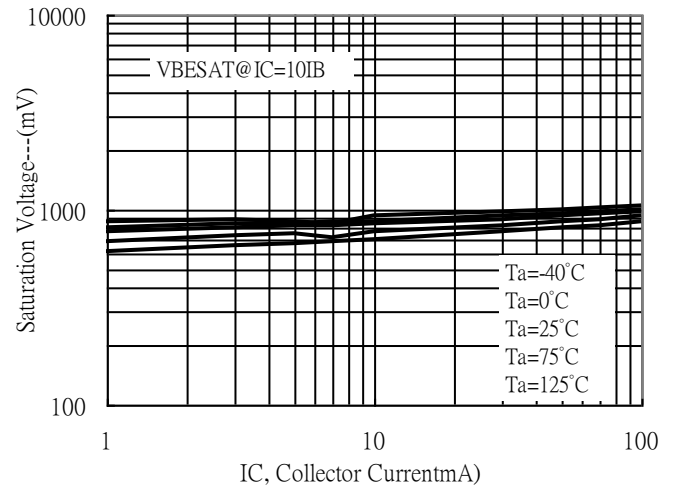

Capacitance vs Reverse-biased Voltage

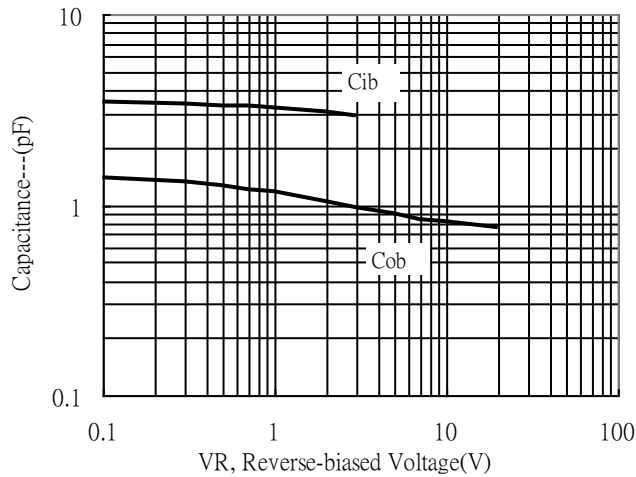

Power Derating Curve

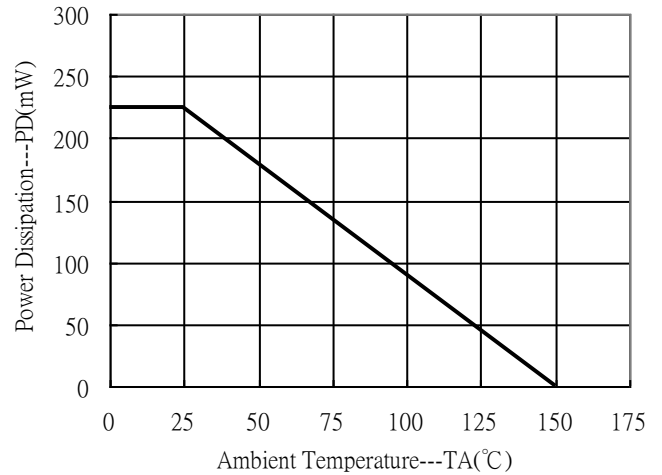

Reel Dimension

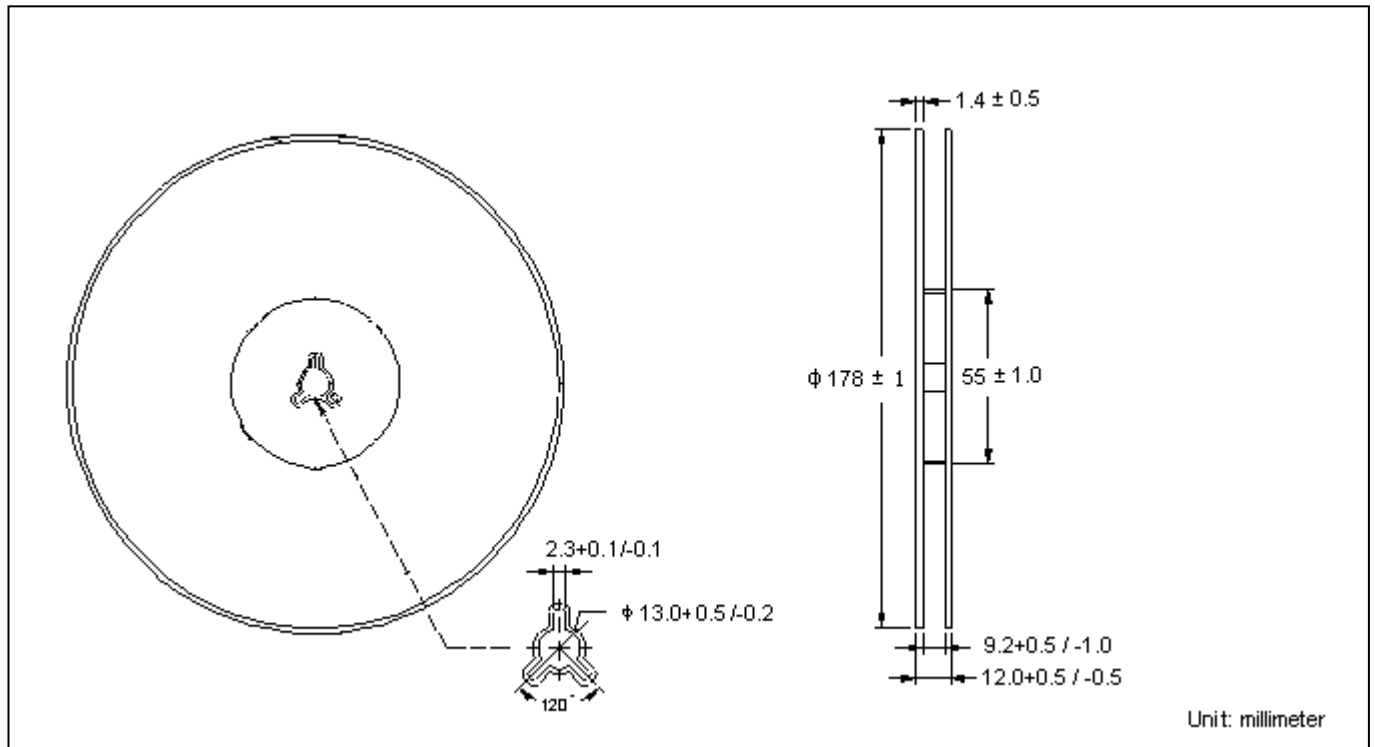

Carrier Tape Dimension

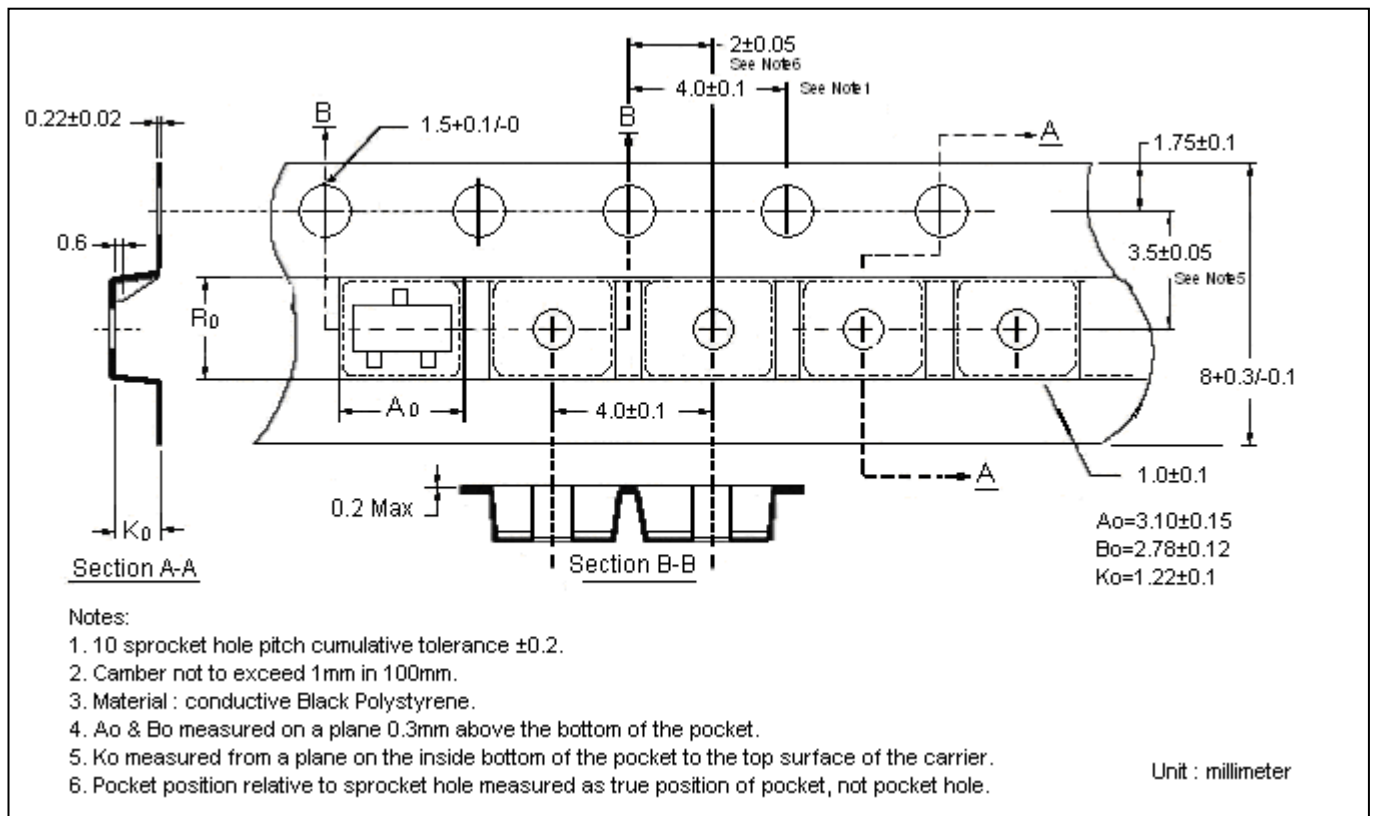

Recommended wave soldering condition

Product	Peak Temperature	Soldering Time
Pb-free devices	260 +0/-5 °C	5 +1/-1 seconds

Recommended temperature profile for IR reflow

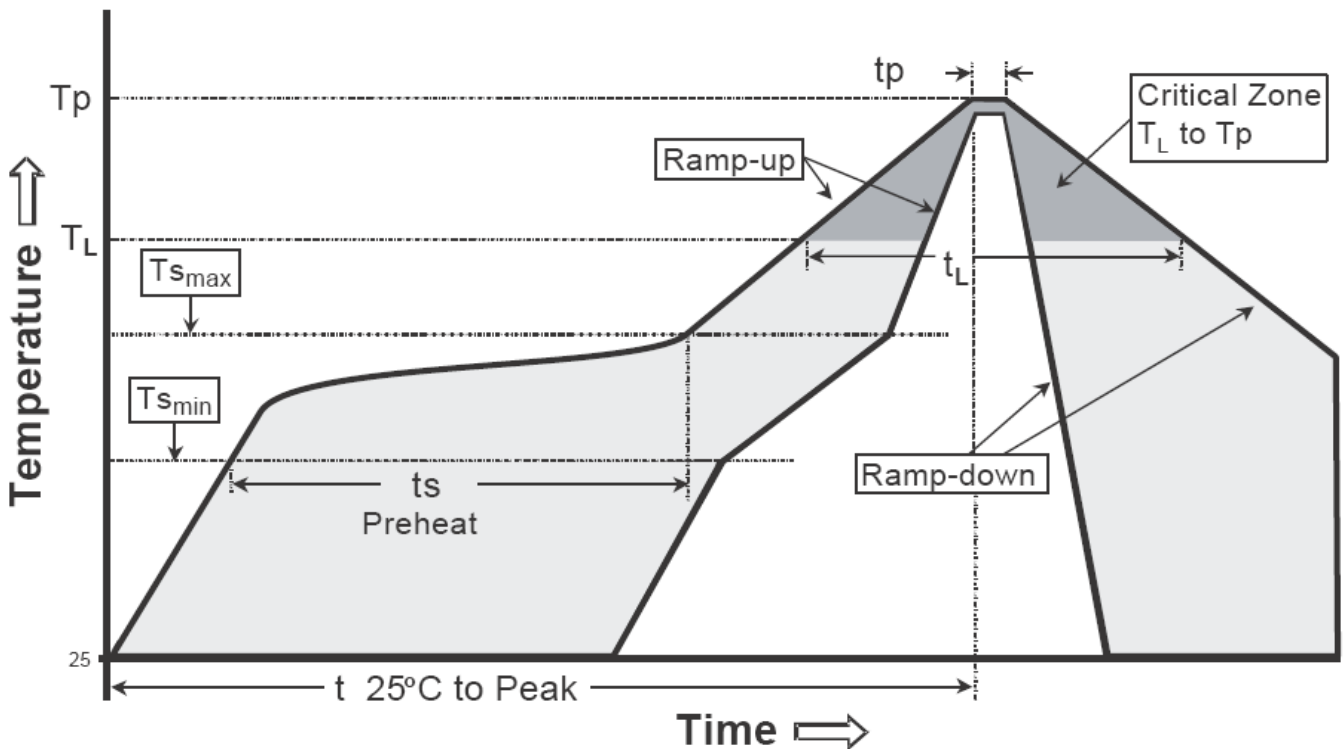

Profile feature	Sn-Pb eutectic Assembly	Pb-free Assembly
Average ramp-up rate (Tsmax to Tp)	3°C/second max.	3°C/second max.
Preheat		
-Temperature Min(Ts min)	100°C	150°C
-Temperature Max(Ts max)	150°C	200°C
-Time(ts min to ts max)	60-120 seconds	60-180 seconds
Time maintained above:		
-Temperature (Tl)	183°C	217°C
- Time (tl)	60-150 seconds	60-150 seconds
Peak Temperature(Tp)	240 +0/-5 °C	260 +0/-5 °C
Time within 5°C of actual peak temperature(tp)	10-30 seconds	20-40 seconds
Ramp down rate	6°C/second max.	6°C/second max.
Time 25 °C to peak temperature	6 minutes max.	8 minutes max.

Note : All temperatures refer to topside of the package, measured on the package body surface.

SOT-23 Dimension

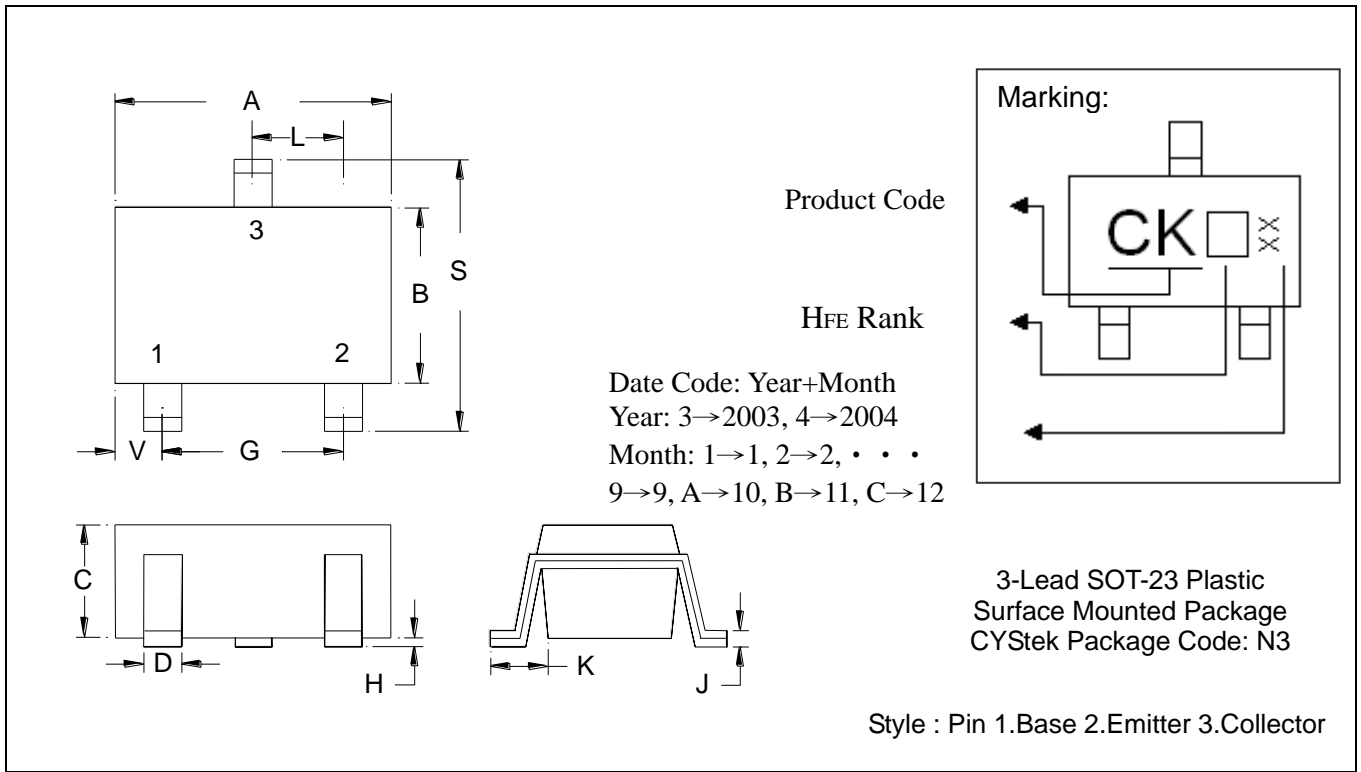

*:Typical

DIM	Inches		Millimeters		DIM	Inches		Millimeters	
	Min.	Max.	Min.	Max.		Min.	Max.	Min.	Max.
A	0.1102	0.1204	2.80	3.04	J	0.0034	0.0070	0.085	0.177
B	0.0472	0.0630	1.20	1.60	K	0.0128	0.0266	0.32	0.67
C	0.0335	0.0512	0.89	1.30	L	0.0335	0.0453	0.85	1.15
D	0.0118	0.0197	0.30	0.50	S	0.0830	0.1083	2.10	2.75
G	0.0669	0.0910	1.70	2.30	V	0.0098	0.0256	0.25	0.65
H	0.0005	0.0040	0.013	0.10					

Notes : 1.Controlling dimension : millimeters.
 2.Maximum lead thickness includes lead finish thickness, and minimum lead thickness is the minimum thickness of base material.
 3.If there is any question with packing specification or packing method, please contact your local CYStek sales office.

Material :

- Lead :Pure tin plated.
- Mold Compound : Epoxy resin family, flammability solid burning class:UL94V-0.

Important Notice:

- All rights are reserved. Reproduction in whole or in part is prohibited without the prior written approval of CYStek.
- CYStek reserves the right to make changes to its products without notice.
- CYStek **semiconductor products are not warranted to be suitable for use in Life-Support Applications, or systems.**
- CYStek assumes no liability for any consequence of customer product design, infringement of patents, or application assistance.