

General Purpose NPN Epitaxial Planar Transistor

BTC2881M3

BV_{CEO}	200V
I_C	1A
$R_{CESAT(MAX)}$	0.86 Ω

Features

- High breakdown voltage, $BV_{CEO} \geq 200V$
- Large continuous collector current capability
- Low collector saturation voltage
- Complementary to BTA1201M3
- Pb-free lead plating and halogen-free package

Symbol

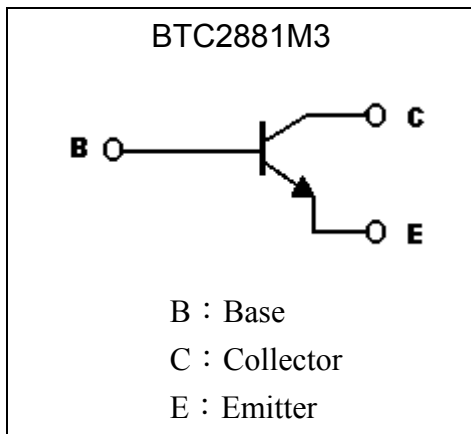

Outline

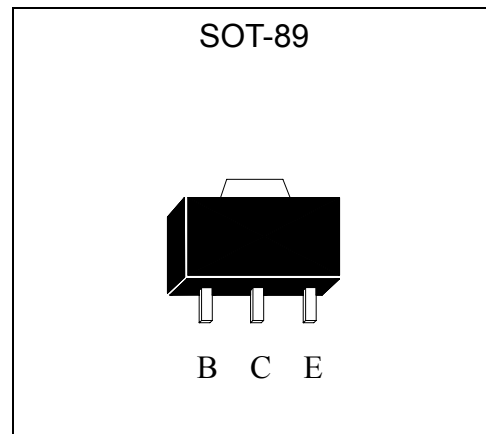

Ordering Information

Device	Package	Shipping
BTC2881M3-X-T2-G	SOT-89 (Pb-free lead plating and halogen-free package)	1000 pcs / Tape & Reel

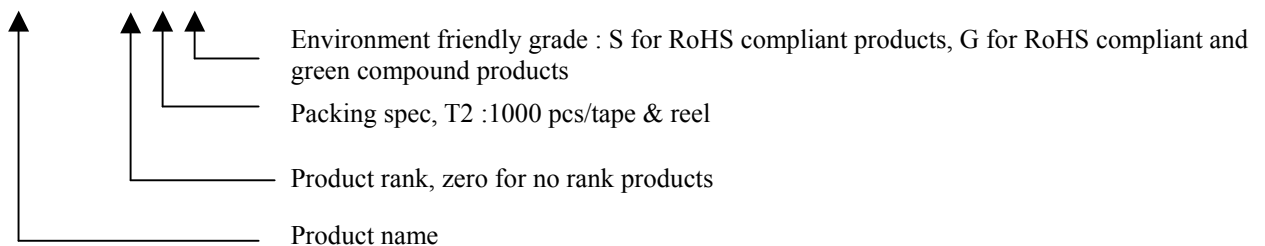



Absolute Maximum Ratings (Ta=25°C)

Parameter	Symbol	Limits	Unit
Collector-Base Voltage	V _{CB0}	300	V
Collector-Emitter Voltage	V _{CEO}	200	V
Emitter-Base Voltage	V _{EBO}	6	V
Collector Current	I _C	1	A
Base Current	I _B	0.2	A
Power Dissipation	P _d	0.6	W
		1 (Note 1)	W
		2 (Note 2)	W
Junction Temperature	T _j	150	°C
Storage Temperature	T _{stg}	-55~+150	°C

Note : 1. When mounted on FR-4 PCB with area measuring 10×10×1 mm
 2. When mounted on ceramic with area measuring 40×40×1 mm

Characteristics (Ta=25°C)

Symbol	Min.	Typ.	Max.	Unit	Test Conditions
BV _{CB0}	300	-	-	V	I _C =10μA
BV _{CEO}	200	-	-	V	I _C =10mA
BV _{EBO}	6	-	-	V	I _E =10μA
I _{CB0}	-	-	100	nA	V _{CB} =300V
I _{EBO}	-	-	100	nA	V _{EB} =6V
*V _{CE(sat)}	-	0.2	0.3	V	I _C =500mA, I _B =50mA
*V _{CE(sat)}	-	-	0.6	V	I _C =700mA, I _B =35mA
*V _{BE(sat)}	-	-	1	V	I _C =500mA, I _B =50mA
*V _{BE(on)}	-	-	1	V	V _{CE} =5V, I _C =500mA
*h _{FE 1}	120	-	-	-	V _{CE} =5V, I _C =50mA
*h _{FE 2}	120	-	320	-	V _{CE} =5V, I _C =100mA
*h _{FE 3}	30	-	-	-	V _{CE} =5V, I _C =700mA
f _T	-	120	-	MHz	V _{CE} =5V, I _C =100mA
C _{ob}	-	-	30	pF	V _{CB} =10V, I _E =0A, f=1MHz

*Pulse Test: Pulse Width ≤380μs, Duty Cycle≤2%

Classification Of h_{FE 2}

Rank	Y	G
Range	120~240	160~320

Recommended soldering footprint

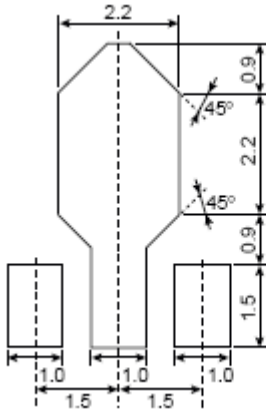

unit : mm

Typical Characteristics

Current Gain vs Collector Current

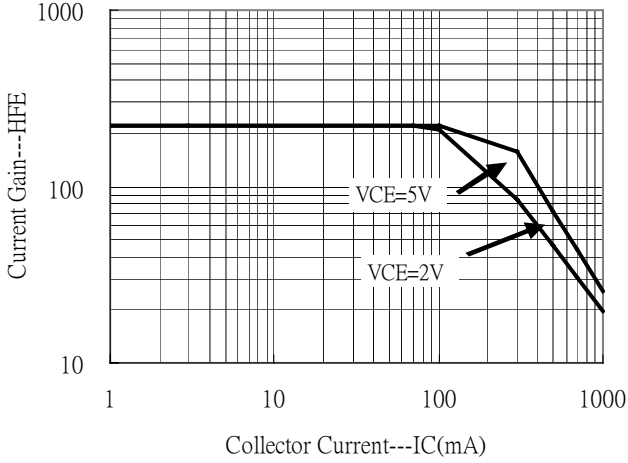

Saturation Voltage vs Collector Current

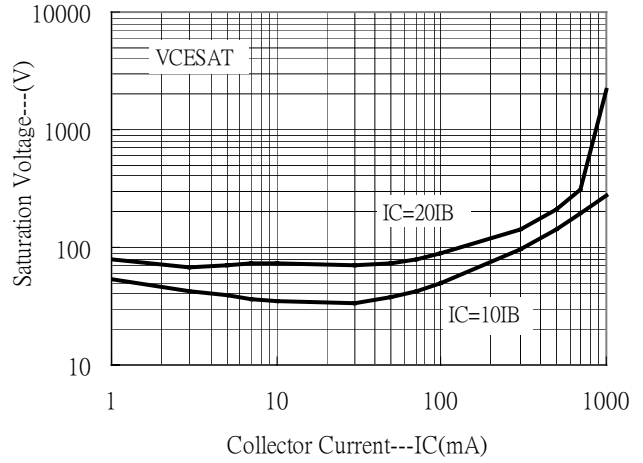

Saturation Voltage vs Collector Current

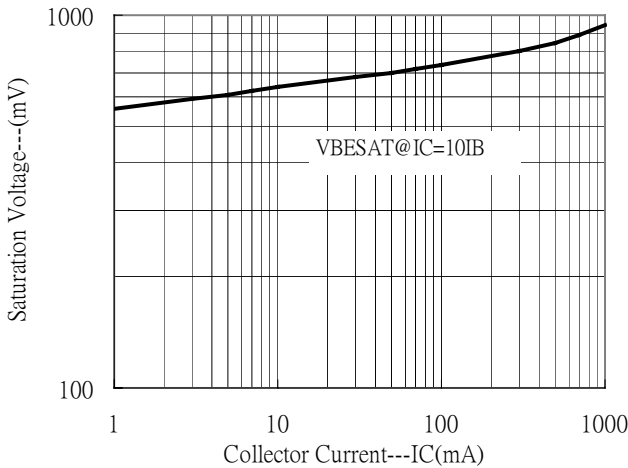

On Voltage vs Collector Current

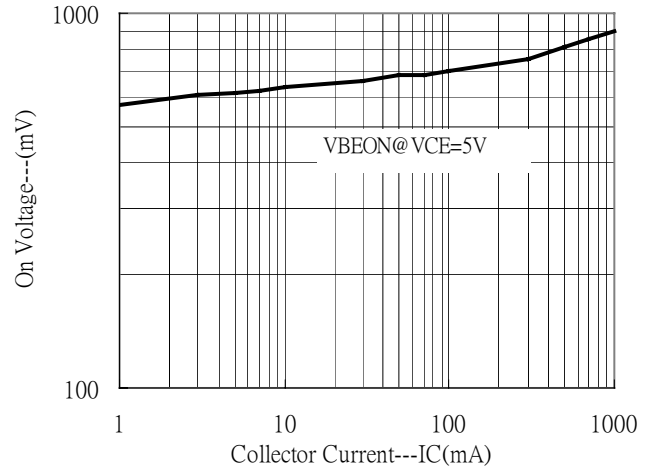

Power Derating Curve

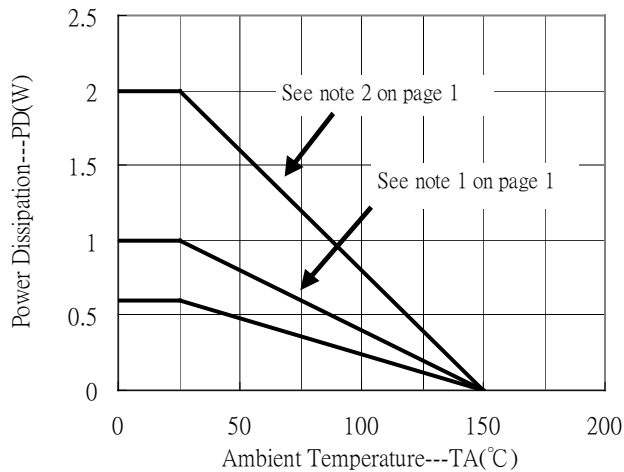

Reel Dimension

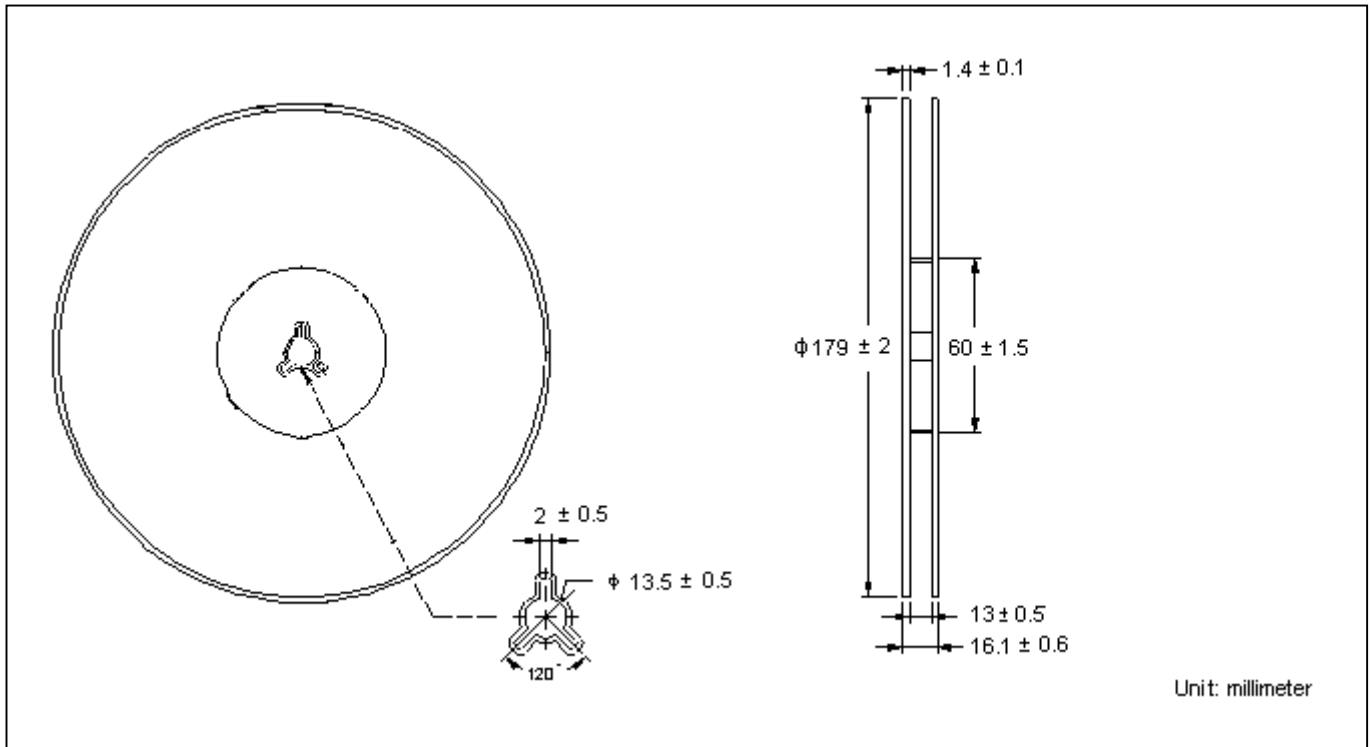

Carrier Tape Dimension

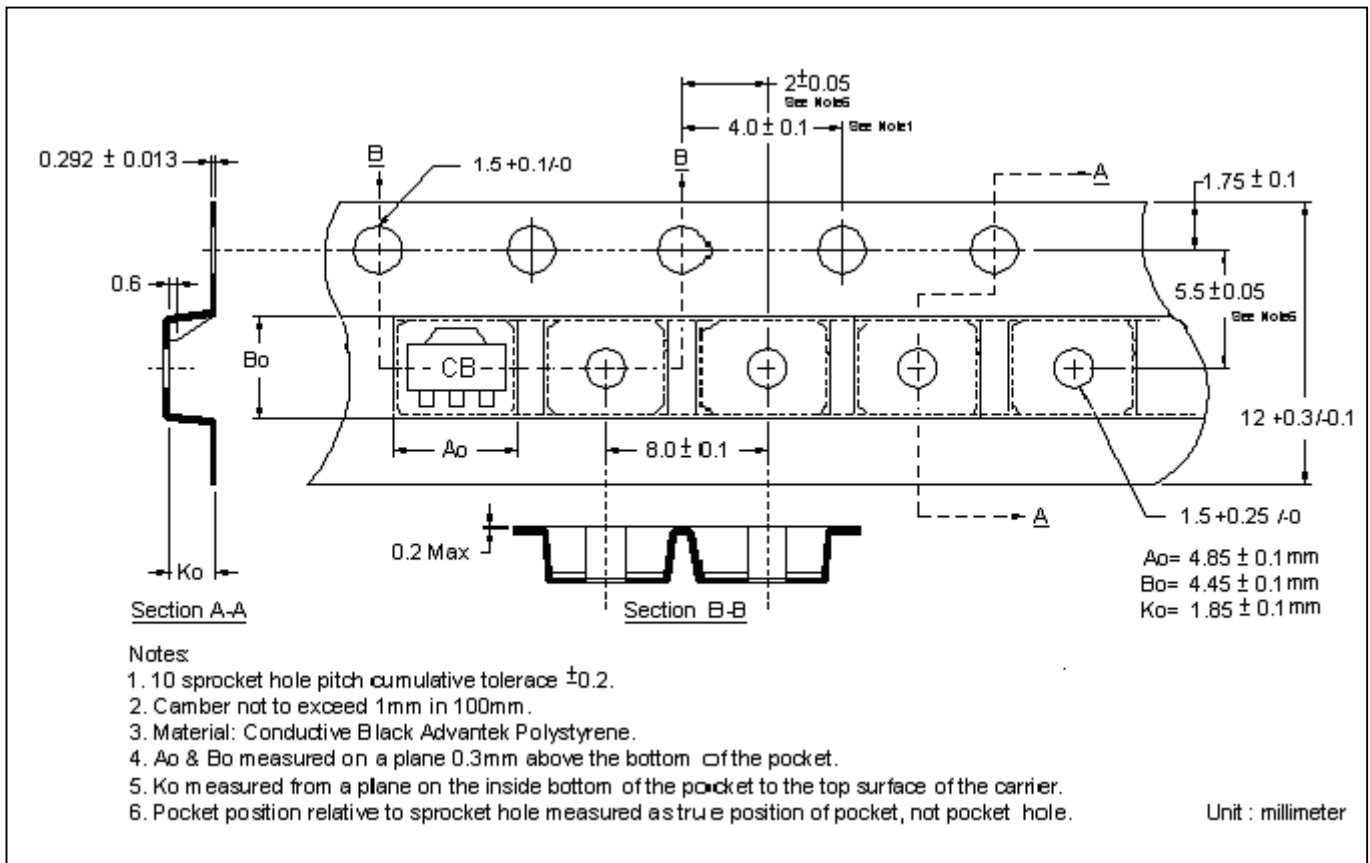

Recommended wave soldering condition

Product	Peak Temperature	Soldering Time
Pb-free devices	260 +0/-5 °C	5 +1/-1 seconds

Recommended temperature profile for IR reflow

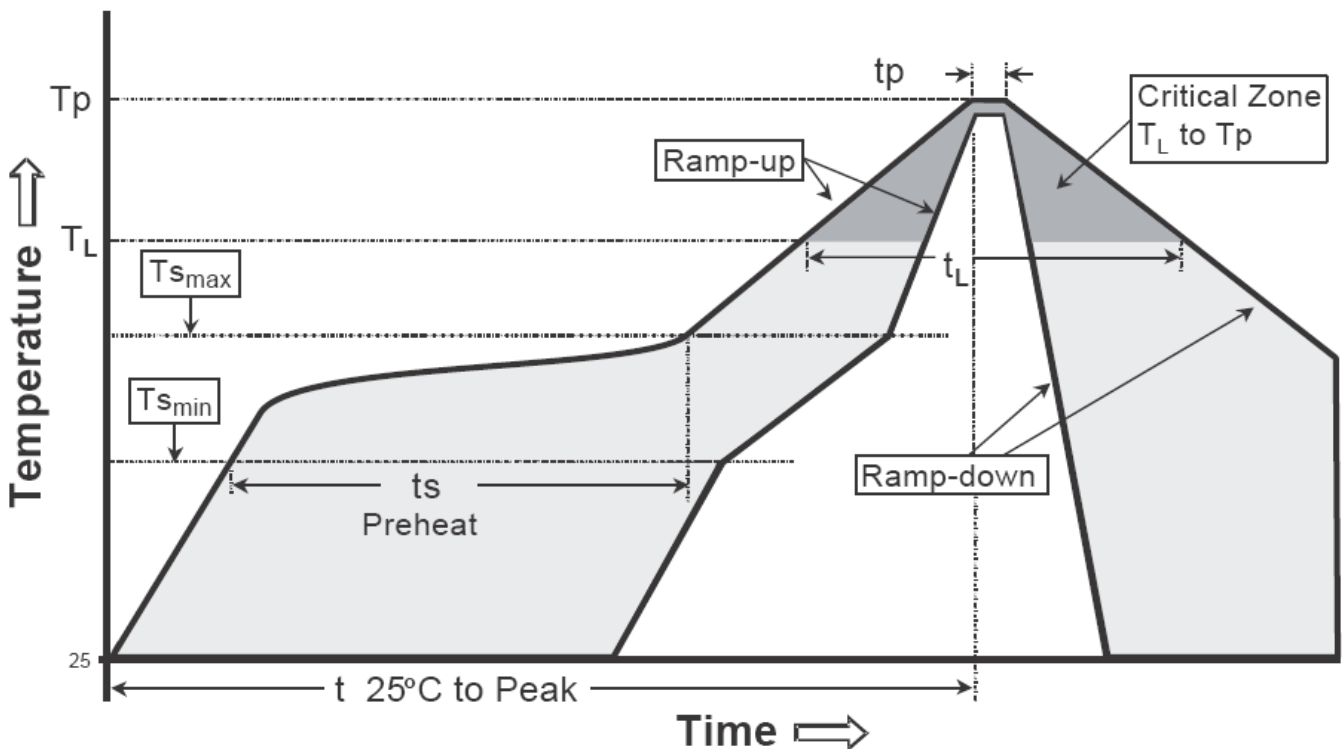

Profile feature	Sn-Pb eutectic Assembly	Pb-free Assembly
Average ramp-up rate (T _{smax} to T _p)	3°C/second max.	3°C/second max.
Preheat		
-Temperature Min(T _{s min})	100°C	150°C
-Temperature Max(T _{s max})	150°C	200°C
-Time(t _{s min} to t _{s max})	60-120 seconds	60-180 seconds
Time maintained above:		
-Temperature (T _L)	183°C	217°C
- Time (t _L)	60-150 seconds	60-150 seconds
Peak Temperature(T _P)	240 +0/-5 °C	260 +0/-5 °C
Time within 5°C of actual peak temperature(tp)	10-30 seconds	20-40 seconds
Ramp down rate	6°C/second max.	6°C/second max.
Time 25 °C to peak temperature	6 minutes max.	8 minutes max.

Note : All temperatures refer to topside of the package, measured on the package body surface.

SOT-89 Dimension

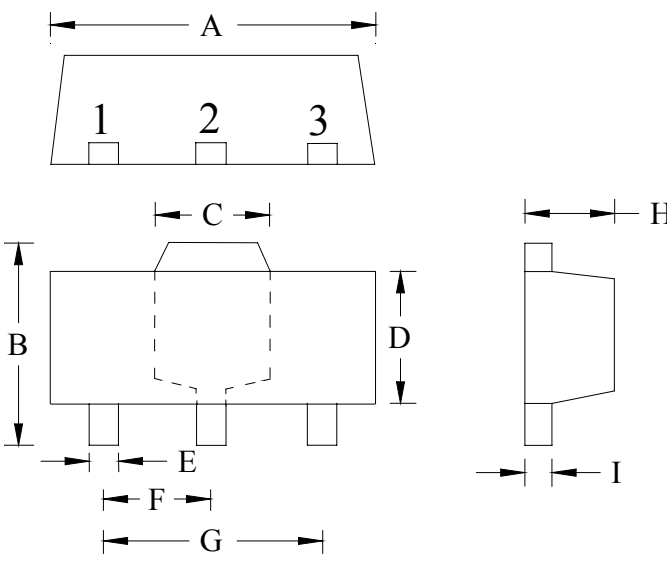

Marking:

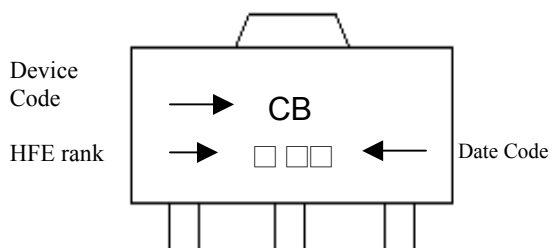

Device Code → CB ←
 HFE rank → □ □ □ ← Date Code

Style: Pin 1. Base 2. Collector 3. Emitter

3-Lead SOT-89 Plastic
 Surface Mounted Package
 CYStek Package Code: M3

DIM	Inches		Millimeters		DIM	Inches		Millimeters	
	Min.	Max.	Min.	Max.		Min.	Max.	Min.	Max.
A	0.1732	0.1811	4.40	4.60	F	0.0591	TYP	1.50	TYP
B	0.1551	0.1673	3.94	4.25	G	0.1181	TYP	3.00	TYP
C	0.0610	REF	1.55	REF	H	0.0551	0.0630	1.40	1.60
D	0.0906	0.1024	2.30	2.60	I	0.0138	0.0173	0.35	0.44
E	0.0126	0.0205	0.32	0.52					

Notes: 1. Controlling dimension: millimeters.
 2. Maximum lead thickness includes lead finish thickness, and minimum lead thickness is the minimum thickness of base material.
 3. If there is any question with packing specification or packing method, please contact your local CYStek sales office.

Material:

- Lead: Pure tin plated.
- Mold Compound: Epoxy resin family, flammability solid burning class: UL94V-0.

Important Notice:

- All rights are reserved. Reproduction in whole or in part is prohibited without the prior written approval of CYStek.
- CYStek reserves the right to make changes to its products without notice.
- CYStek **semiconductor products are not warranted to be suitable for use in Life-Support Applications, or systems.**
- CYStek assumes no liability for any consequence of customer product design, infringement of patents, or application assistance.