

# General Purpose NPN Epitaxial Planar Transistor

## BTC2383A3

### Features

- High breakdown voltage,  $BV_{CEO} \geq 200V$
- Large continuous collector current capability
- Low collector saturation voltage
- Complementary to BTA1013A3
- Pb-free package

### Symbol

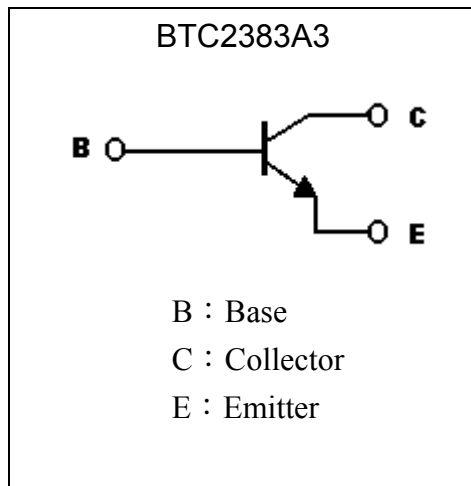

### Outline

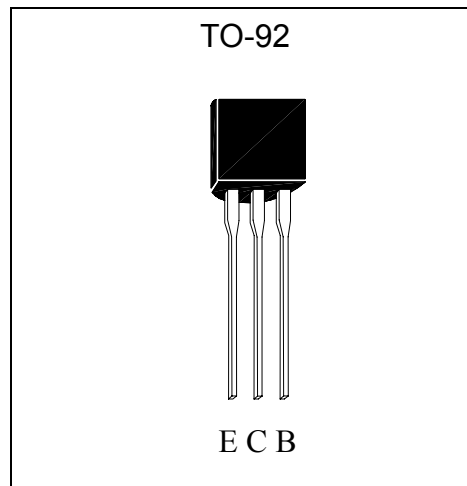

### Absolute Maximum Ratings (Ta=25°C)

Parameter	Symbol	Limits	Unit
Collector-Base Voltage	$V_{CB0}$	280	V
Collector-Emitter Voltage	$V_{CEO}$	200	V
Emitter-Base Voltage	$V_{EB0}$	6	V
Collector Current	$I_C$	1	A
Base Current	$I_B$	0.5	A
Power Dissipation	$P_d$	900	mW
Junction Temperature	$T_j$	150	°C
Storage Temperature	$T_{stg}$	-55~+150	°C

**Characteristics (Ta=25°C)**

Symbol	Min.	Typ.	Max.	Unit	Test Conditions
BV <sub>CBO</sub>	280	-	-	V	I <sub>C</sub> =10μA
BV <sub>CEO</sub>	200	-	-	V	I <sub>C</sub> =10mA
BV <sub>EBO</sub>	6	-	-	V	I <sub>E</sub> =10μA
I <sub>CBO</sub>	-	-	100	nA	V <sub>CB</sub> =250V
I <sub>EBO</sub>	-	-	100	nA	V <sub>EB</sub> =6V
*V <sub>CE(sat)</sub>	-	0.2	0.5	V	I <sub>C</sub> =500mA, I <sub>B</sub> =50mA
*V <sub>CE(sat)</sub>	-	-	1	V	I <sub>C</sub> =1A, I <sub>B</sub> =50mA
*V <sub>BE(sat)</sub>	-	-	0.9	V	I <sub>C</sub> =500mA, I <sub>B</sub> =50mA
*V <sub>BE(on)</sub>	0.45	-	0.75	V	V <sub>CE</sub> =5V, I <sub>C</sub> =5mA
*h <sub>FE 1</sub>	100	-	-	-	V <sub>CE</sub> =5V, I <sub>C</sub> =50mA
*h <sub>FE 2</sub>	100	-	320	-	V <sub>CE</sub> =5V, I <sub>C</sub> =200mA
*h <sub>FE 3</sub>	50	-	-	-	V <sub>CE</sub> =5V, I <sub>C</sub> =1A
f <sub>T</sub>	20	100	-	MHz	V <sub>CE</sub> =5V, I <sub>C</sub> =200mA
C <sub>ob</sub>	-	-	20	pF	V <sub>CB</sub> =10V, I <sub>E</sub> =0A, f=1MHz

\*Pulse Test: Pulse Width ≤380μs, Duty Cycle ≤2%

**Classification Of hFE 2**

Rank	O	Y
Range	100~200	160~320

**Ordering Information**

Device	Package	Shipping	Marking
BTC2383A3	TO-92 (Pb-free)	2000 pcs / Tape & Box	C2383

**Characteristic Curves**

Current Gain vs Collector Current

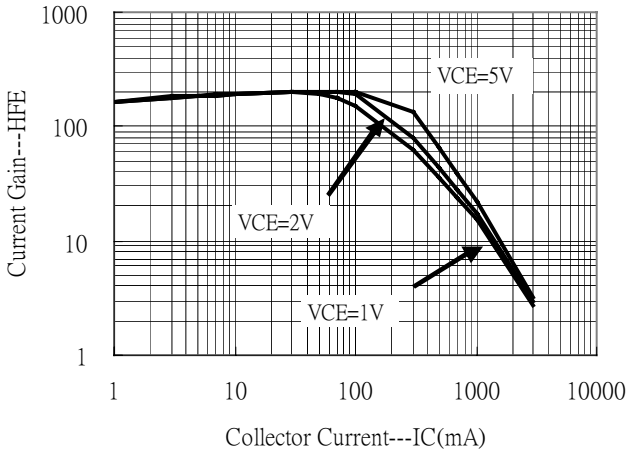

Saturation Voltage vs Collector Current

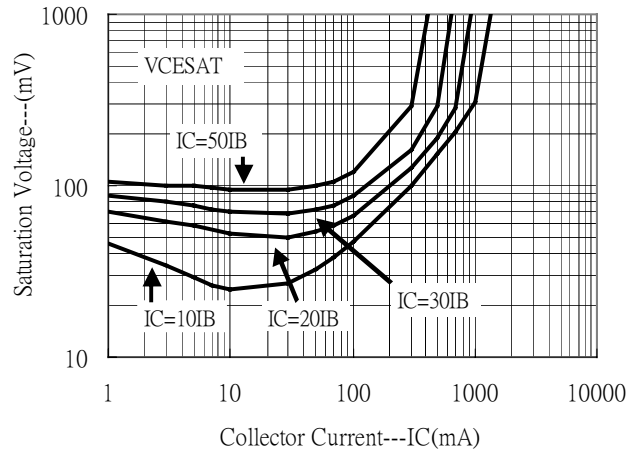

Saturation Voltage vs Collector Current

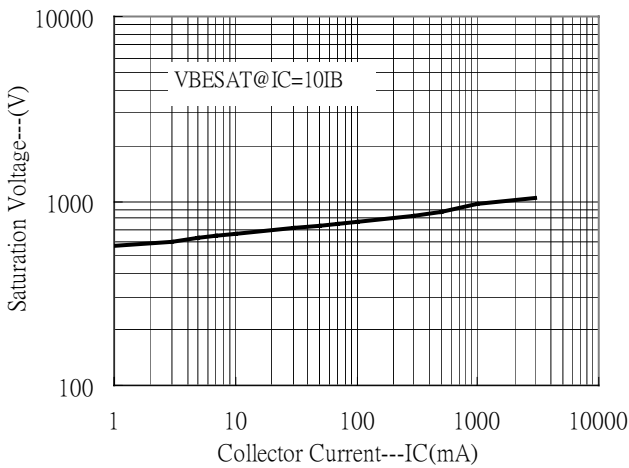

Power Derating Curve

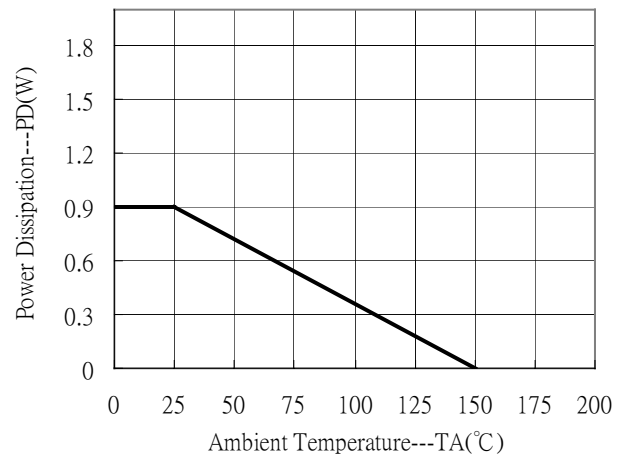



### Characteristic Curves(Cont.)

Output Characteristics

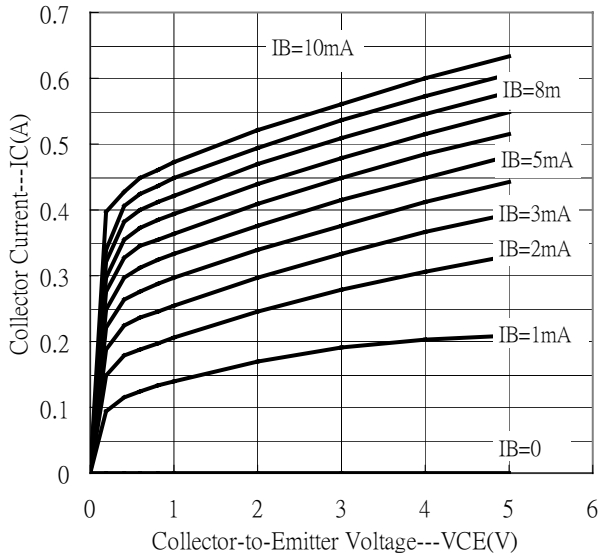

Output Characteristics

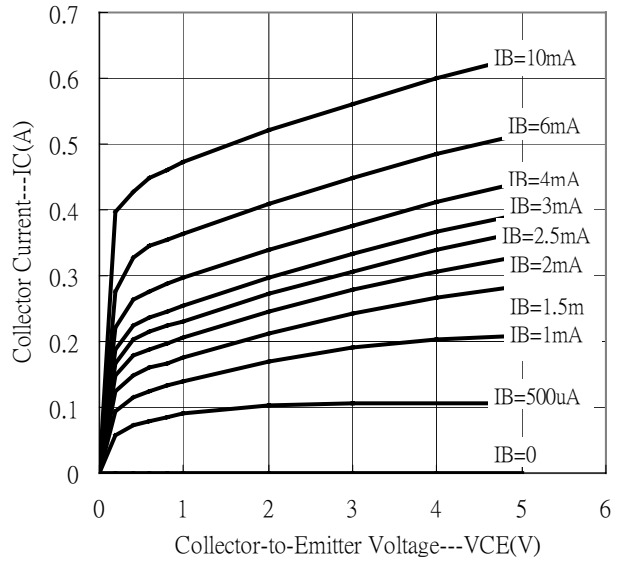

Output Capacitance vs Reverse Biased Voltage

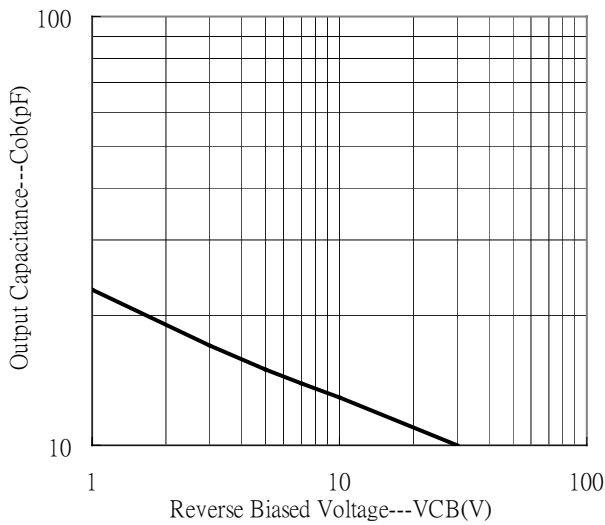

Safe Operating Area

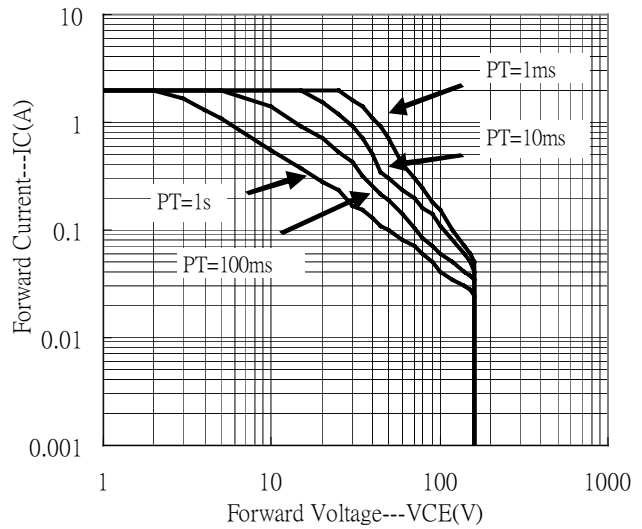



**Product Designation**

BT X XXXX XX  
(1) (2) (3) (4)

(1) Indicates that transistor is bipolar

(2) Indicates polarity  
A, B . . . . PNP  
C, D . . . . NPN

(3) Indicates device random number

(4) Indicates package shape  
N3 . . . SOT-23  
A3 . . . TO-92  
E3 . . . TO-220AB  
FP . . . TO-220FP  
J3 . . . TO-252  
I3 . . . TO-251  
F3 . . . TO-263  
D3 . . . TO-126ML  
T3 . . . TO-126  
L3 . . . SOT-223  
M3 . . . SOT-89  
S3 . . . SOT-323

**Recommended IR reflow profile**

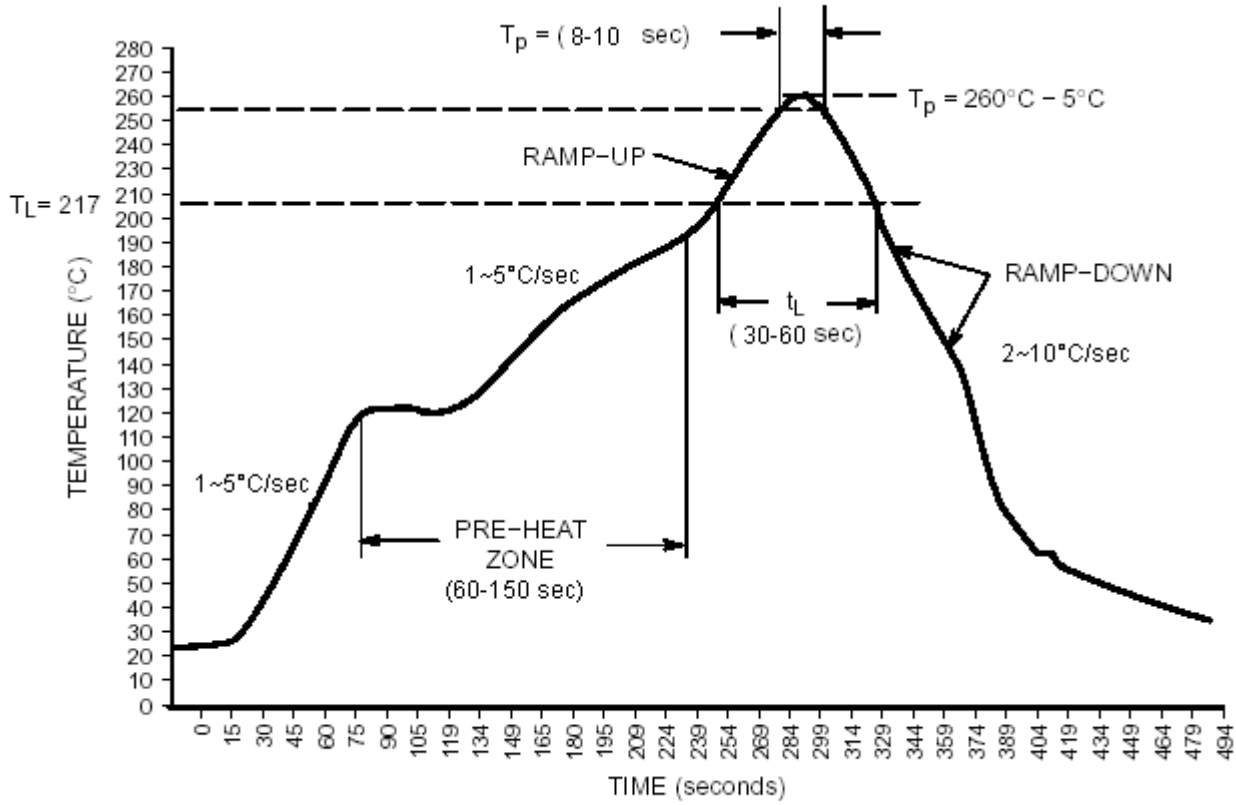

## Recommended temperature profile for wave soldering

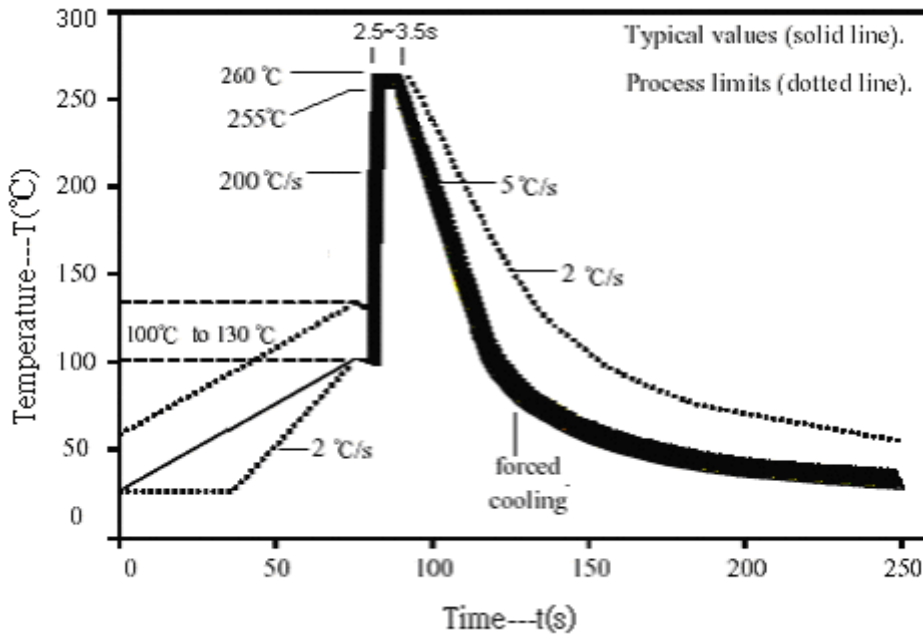

### Recommendation:

1. Preheat temperature at solder side must be between 100 and 130 °C for 80 to 100 seconds.
2. Temperature ramp-up rate : 1~2 °C/s
3. The temperature gradient between preheat and wave soldering must be smaller than +160°C.
4. Terminations must go through the wave simultaneously.
5. Travel through the wave from 255 to 260°C for 2.5 to 3.5 seconds
6. Temperature ramp-down rate : 2~3 °C/s

**TO-92 Taping Outline**

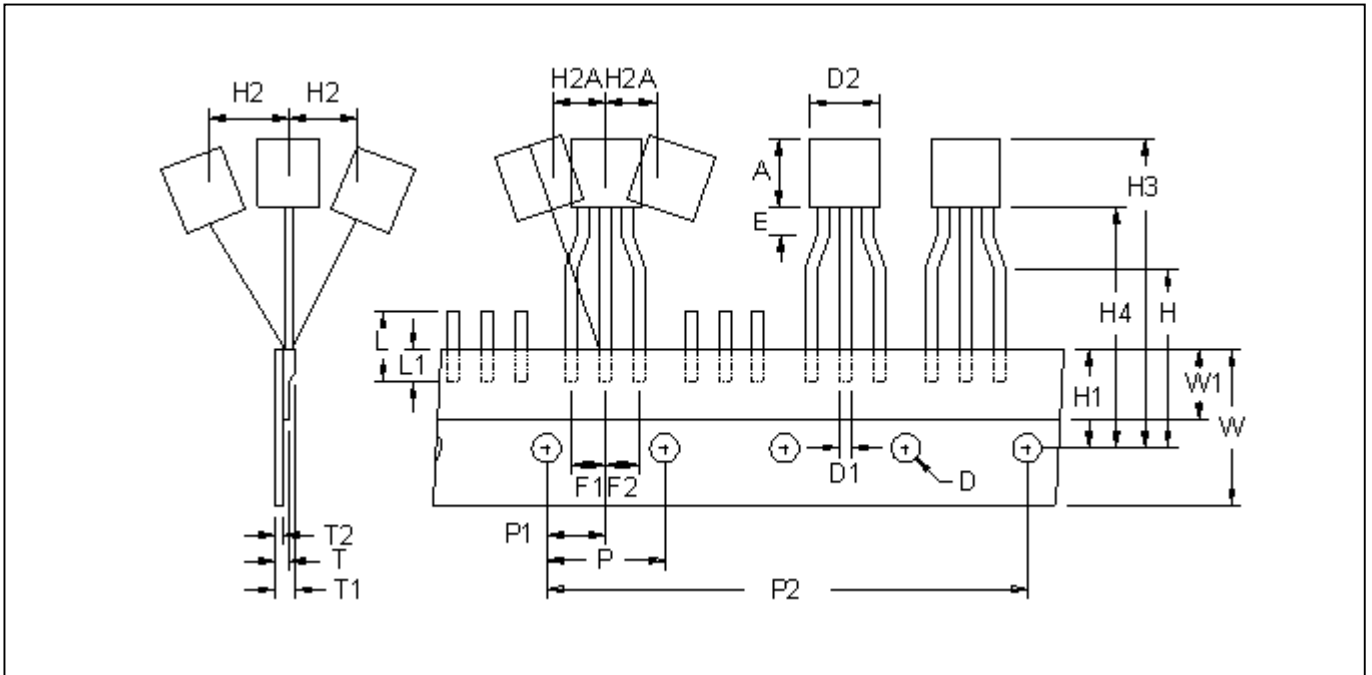

DIM	Item	Millimeters	
		Min.	Max.
A	Component body height	4.33	4.83
D	Tape Feed Diameter	3.80	4.20
D1	Lead Diameter	0.36	0.53
D2	Component Body Diameter	4.33	4.83
E		1.5	2.0
F1,F2	Component Lead Pitch	2.40	2.90
F1,F2	F1-F2	-	±0.3
H	Height Of Seating Plane	15.50	16.50
H1	Feed Hole Location	8.50	9.50
H2	Front To Rear Deflection	-	1
H2A	Deflection Left Or Right	-	1
H3	Component Height	-	27
H4	Feed Hole To Bottom Of Component	-	21
L	Lead Length After Component Removal	-	11
L1	Lead Wire Enclosure	2.50	-
P	Feed Hole Pitch	12.50	12.90
P1	Center Of Seating Plane Location	5.95	6.75
P2	4 Feed Hole Pitch	50.30	51.30
T	Over All Tape Thickness	-	0.55
T1	Total Taped Package Thickness	-	1.42
T2	Carrier Tape Thickness	0.36	0.68
W	Tape Width	17.50	19.00
W1	Adhesive Tape Width	5.00	7.00
-	20 pcs Pitch	253	255



**TO-92 Dimension**

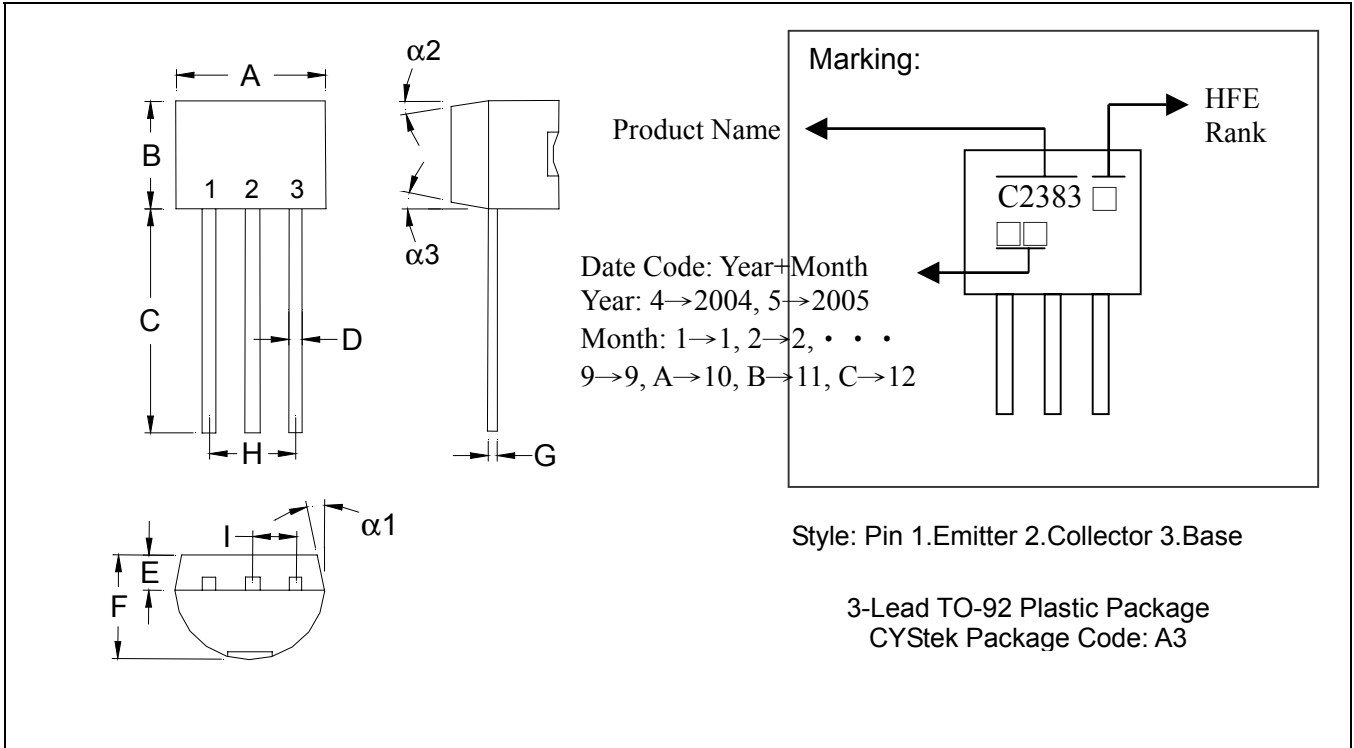

\*: Typical

DIM	Inches		Millimeters		DIM	Inches		Millimeters	
	Min.	Max.	Min.	Max.		Min.	Max.	Min.	Max.
A	0.1704	0.1902	4.33	4.83	G	0.0142	0.0220	0.36	0.56
B	0.1704	0.1902	4.33	4.83	H	-	*0.1000	-	*2.54
C	0.5000	-	12.70	-	I	-	*0.0500	-	*1.27
D	0.0142	0.0220	0.36	0.56	$\alpha 1$	-	*5°	-	*5°
E	-	*0.0500	-	*1.27	$\alpha 2$	-	*2°	-	*2°
F	0.1323	0.1480	3.36	3.76	$\alpha 3$	-	*2°	-	*2°

**Notes:** 1.Controlling dimension: millimeters.  
 2.Maximum lead thickness includes lead finish thickness, and minimum lead thickness is the minimum thickness of base material.  
 3.If there is any question with packing specification or packing method, please contact your local CYStek sales office.

**Material:**

- Lead: 42 Alloy ; solder plating
- Mold Compound: Epoxy resin family, flammability solid burning class: UL94V-0

**Important Notice:**

- All rights are reserved. Reproduction in whole or in part is prohibited without the prior written approval of CYStek.
- CYStek reserves the right to make changes to its products without notice.
- CYStek **semiconductor products are not warranted to be suitable for use in Life-Support Applications, or systems.**
- CYStek assumes no liability for any consequence of customer product design, infringement of patents, or application assistance.