

NPN Epitaxial Planar Transistor

BTC1510F3

Description

The BTC1510F3 is a NPN Darlington transistor, designed for general purpose amplifier and low speed switching application.

Features:

- High BV_{CEO}
- Low $V_{CE(SAT)}$
- High current gain
- Monolithic construction with built-in base-emitter shunt resistors
- Pb-free lead plating package

Equivalent Circuit

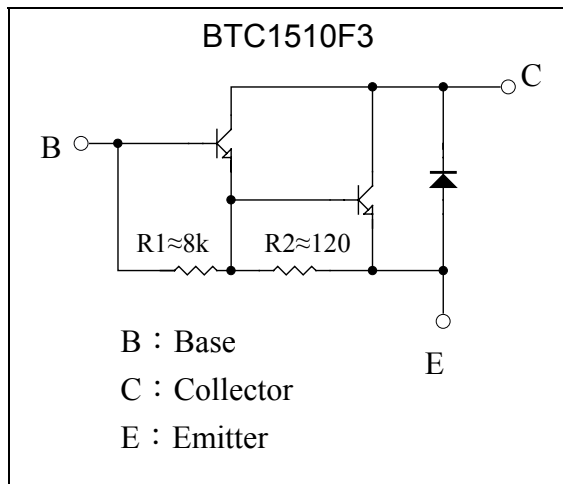

Outline

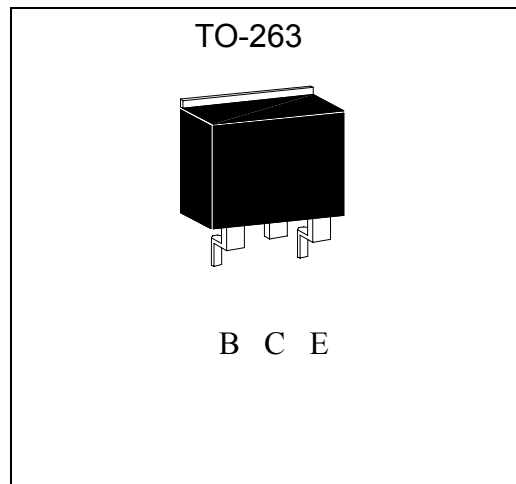

Ordering Information

Device	Package	Shipping
BTC1510F3-0-T7-X	TO-263 (RoHS compliant package)	800 pcs/tape & reel

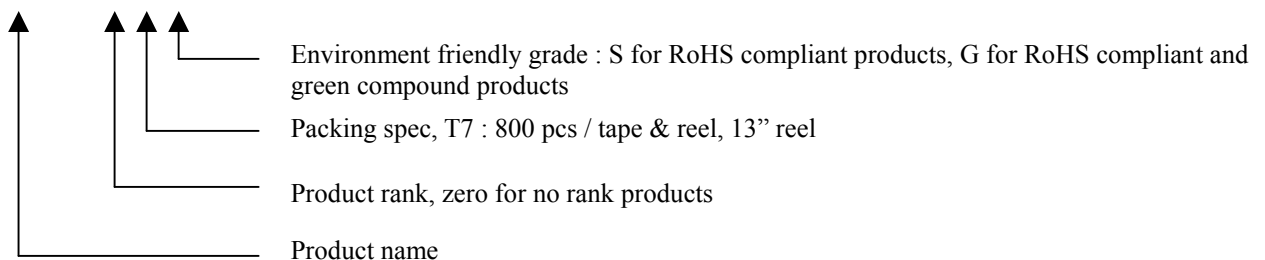



Absolute Maximum Ratings (Ta=25°C)

Parameter	Symbol	Limits	Unit
Collector-Base Voltage	V _{CB0}	150	V
Collector-Emitter Voltage	V _{CE0}	150	V
Emitter-Base Voltage	V _{EB0}	5	V
Collector Current	I _{C(DC)}	10	A
	I _{C(Pulse)}	15 *1	
Power Dissipation	P _d (T _A =25°C)	2	W
	P _d (T _C =25°C)	60	
Operating Junction Temperature Range	T _j	-55~+150	°C
Storage Temperature Range	T _{stg}	-55~+150	°C

Note : *1. Single Pulse Pw=100ms

Thermal Data

Parameter	Symbol	Value	Unit
Thermal Resistance, Junction-to-case, max	R _{th,j-c}	2.08	°C/W
Thermal Resistance, Junction-to-ambient, max	R _{th,j-a}	62.5	°C/W

Characteristics (Ta=25°C)

Symbol	Min.	Typ.	Max.	Unit	Test Conditions
BV _{CB0}	150	-	-	V	I _C =100μA, I _E =0
BV _{CE0}	150	-	-	V	I _C =1mA, I _B =0
I _{CE0}	-	-	200	μA	V _{CE} =150V, I _E =0
I _{CB0}	-	-	200	μA	V _{CB} =150V, I _E =0
I _{EB0}	-	-	2	mA	V _{EB} =5V, I _C =0
*V _{CE(sat)} 1	-	-	1.5	V	I _C =5A, I _B =10mA
*V _{CE(sat)} 2	-	-	3	V	I _C =10A, I _B =100mA
*V _{CE(sat)} 3	-	-	2	V	I _C =5A, I _B =2.5mA
*V _{BE(sat)}	-	-	2	V	I _C =5A, I _B =5mA
*V _{BE(on)} 1	-	-	2.8	V	V _{CE} =3V, I _C =5A
*V _{BE(on)} 2	-	-	4.5	V	V _{CE} =3V, I _C =10A
*V _{FEC}	-	-	3	V	I _C =5A
*h _{FE} 1	2	-	20	K	V _{CE} =3V, I _C =5A
*h _{FE} 2	100	-	-	-	V _{CE} =3V, I _C =10A

*Pulse Test : Pulse Width ≤380μs, Duty Cycle≤2%

Typical Characteristics

Current Gain vs Collector Current

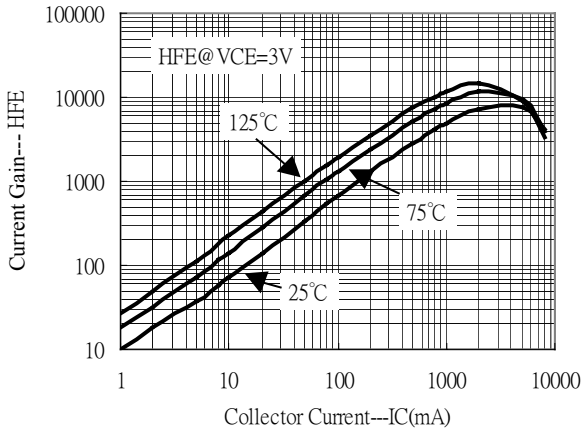

Saturation Voltage vs Collector Current

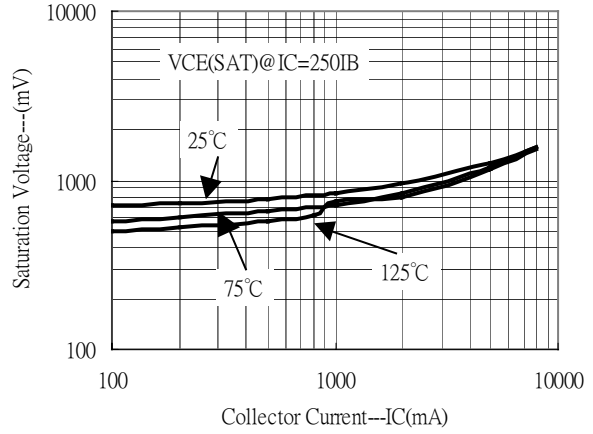

Saturation Voltage vs Collector Current

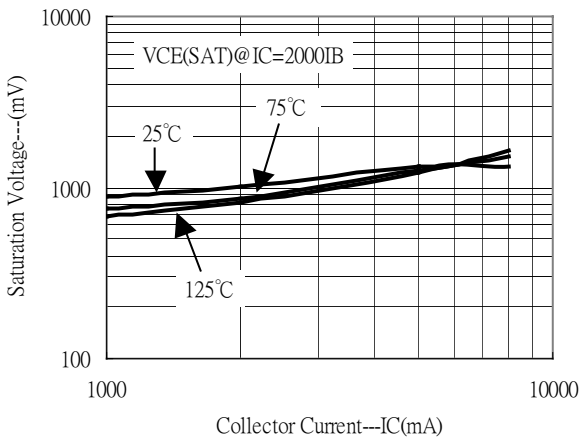

Saturation Voltage vs Collector Current

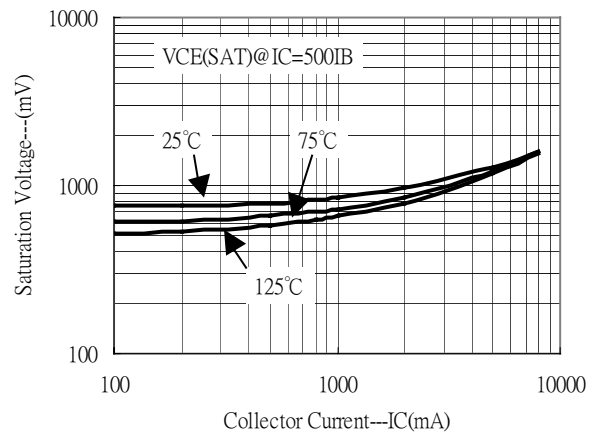

Saturation Voltage vs Collector Current

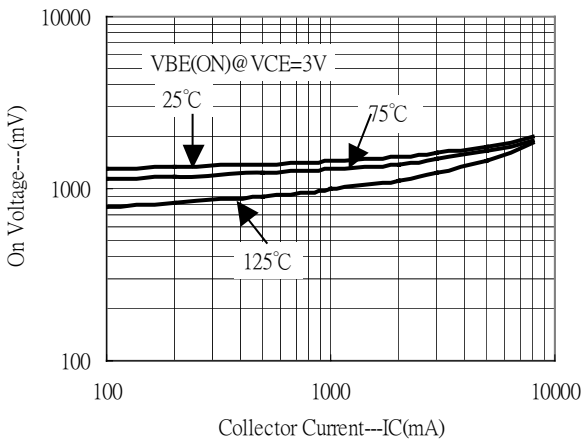

Power Derating Curve

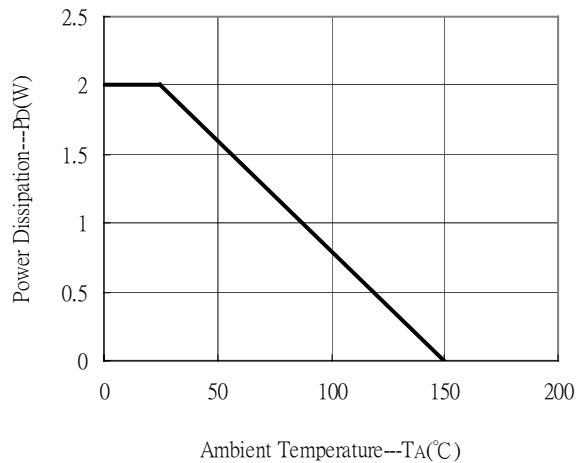



Typical Characteristics(Cont.)

Power Derating Curve

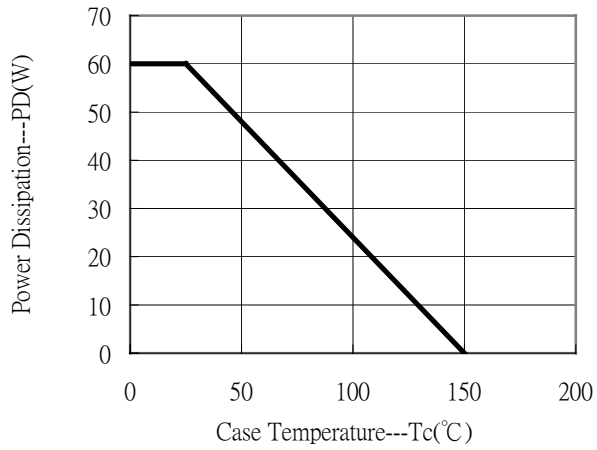

Reel Dimension

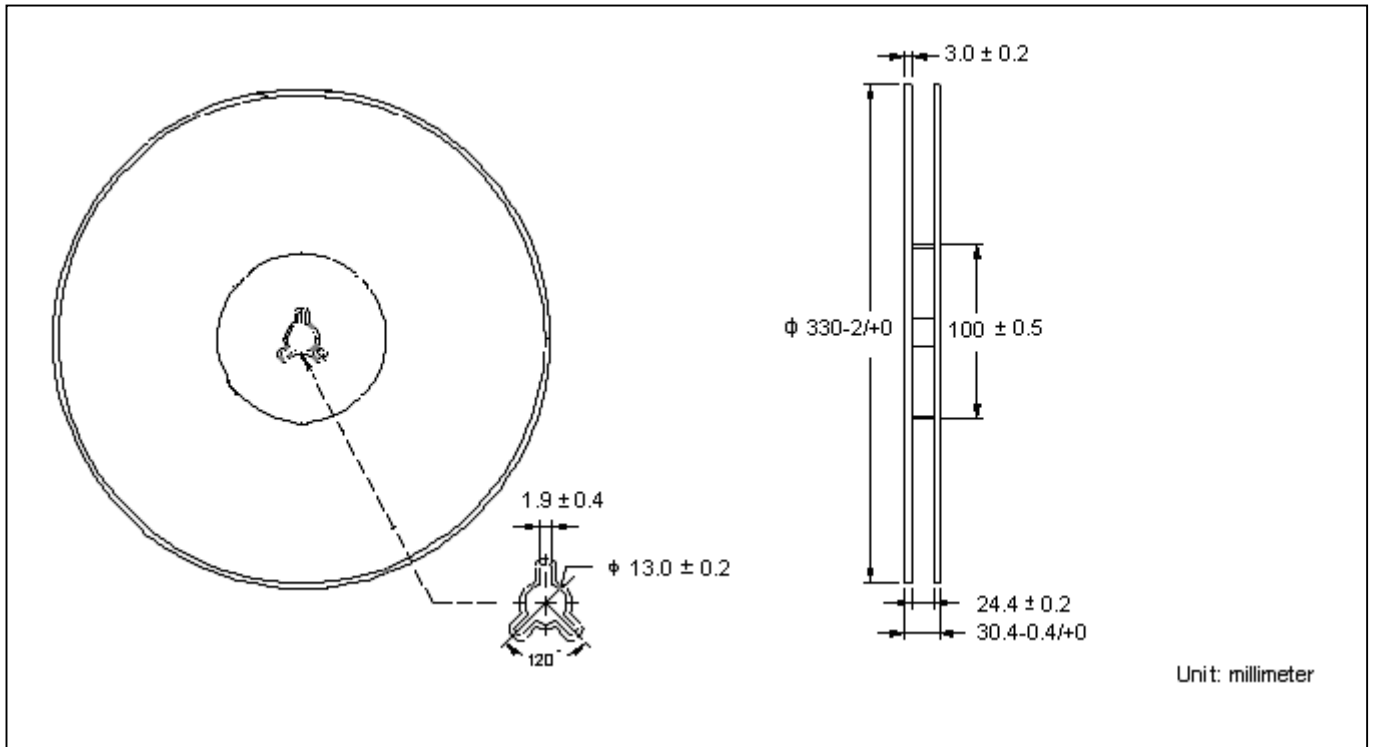

Carrier Tape Dimension

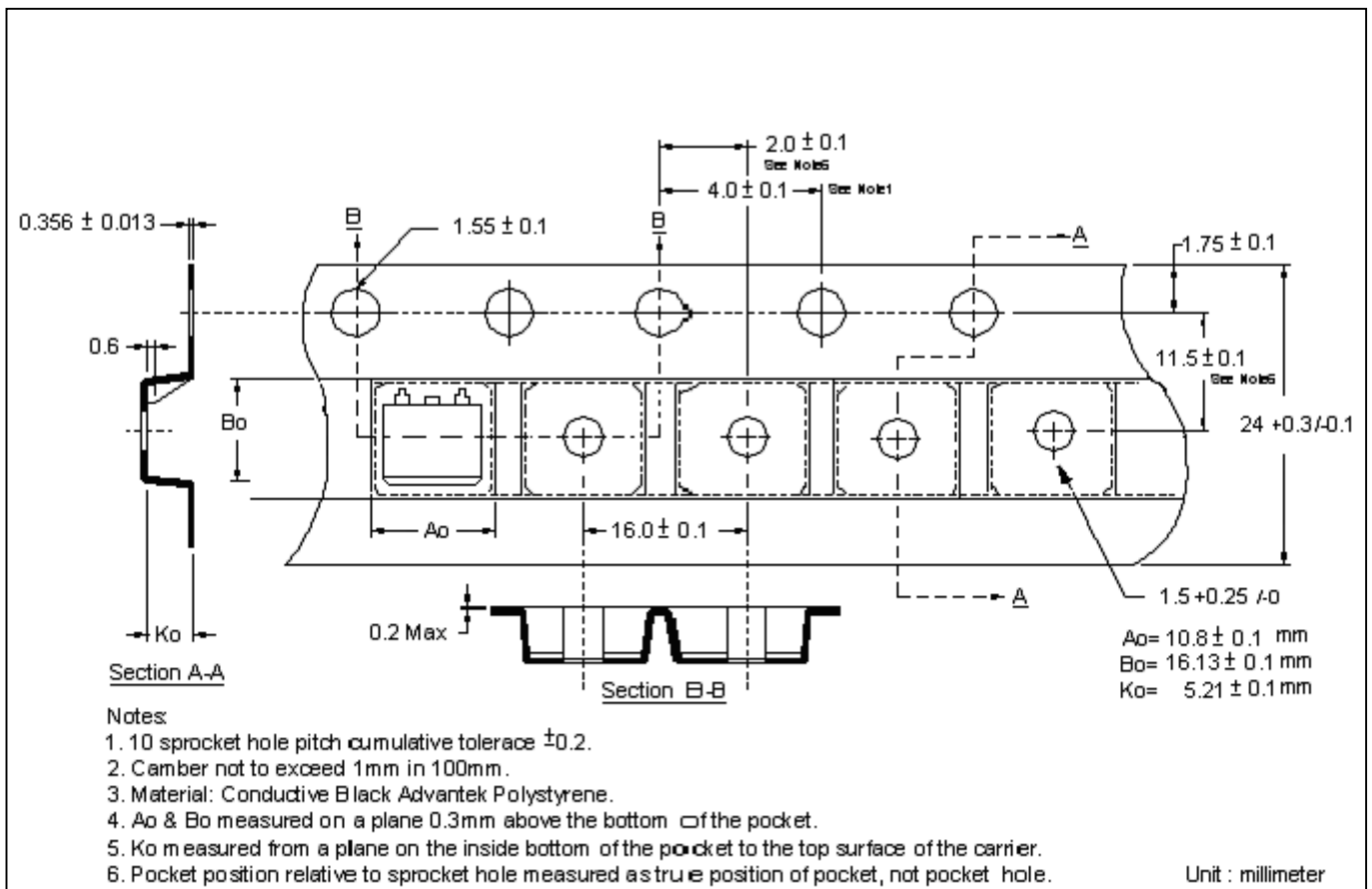

Recommended wave soldering condition

Product	Peak Temperature	Soldering Time
Pb-free devices	260 +0/-5 °C	5 +1/-1 seconds

Recommended temperature profile for IR reflow

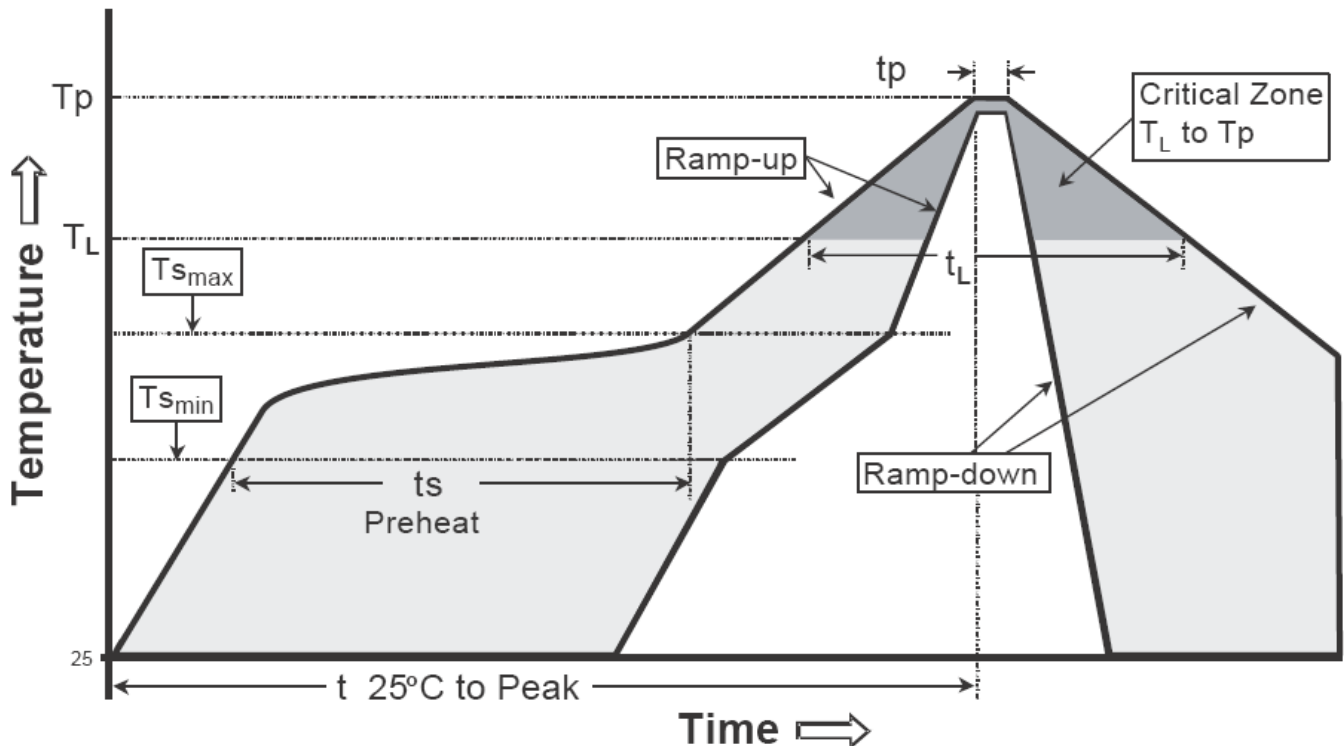

Profile feature	Sn-Pb eutectic Assembly	Pb-free Assembly
Average ramp-up rate (Tsmax to Tp)	3°C/second max.	3°C/second max.
Preheat		
-Temperature Min(Ts min)	100°C	150°C
-Temperature Max(Ts max)	150°C	200°C
-Time(ts min to ts max)	60-120 seconds	60-180 seconds
Time maintained above:		
-Temperature (TL)	183°C	217°C
- Time (tL)	60-150 seconds	60-150 seconds
Peak Temperature(TP)	240 +0/-5 °C	260 +0/-5 °C
Time within 5°C of actual peak temperature(tp)	10-30 seconds	20-40 seconds
Ramp down rate	6°C/second max.	6°C/second max.
Time 25 °C to peak temperature	6 minutes max.	8 minutes max.

Note : All temperatures refer to topside of the package, measured on the package body surface.

TO-263 Dimension

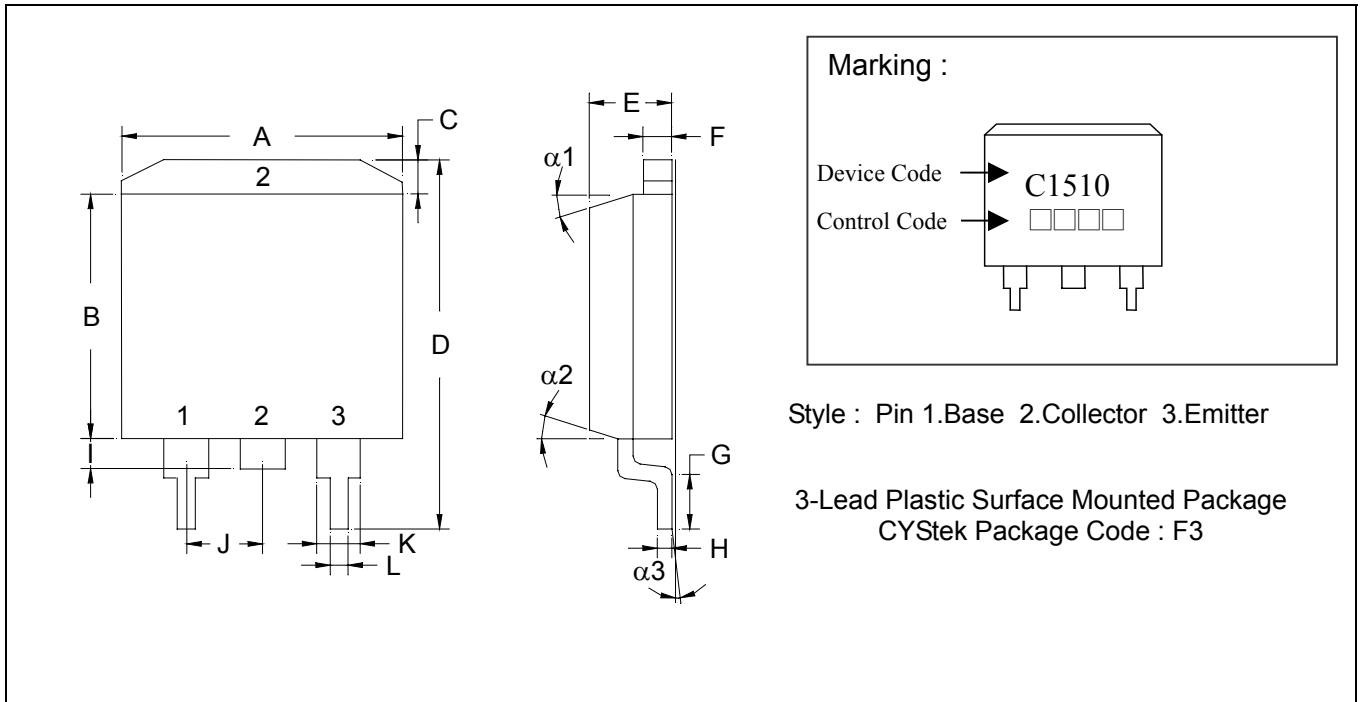

*:Typical

DIM	Inches		Millimeters		DIM	Inches		Millimeters	
	Min.	Max.	Min.	Max.		Min.	Max.	Min.	Max.
A	0.3800	0.4050	9.65	10.29	I	0.0500	0.0700	1.27	1.78
B	0.3300	0.3700	8.38	9.40	J	-	*0.1000	-	*2.54
C	-	0.0550	-	1.40	K	0.0450	0.0550	1.14	1.40
D	0.5750	0.6250	14.61	15.88	L	0.0200	0.0390	0.51	0.99
E	0.1600	0.1900	4.06	4.83	$\alpha 1$	-	-	6°	8°
F	0.0450	0.0550	1.14	1.40	$\alpha 2$	-	-	6°	8°
G	0.0900	0.1100	2.29	2.79	$\alpha 3$	-	-	0°	5°
H	0.0180	0.0290	0.46	0.74					

Notes : 1.Controlling dimension : millimeters.
 2.Maximum lead thickness includes lead finish thickness, and minimum lead thickness is the minimum thickness of base material.
 3.If there is any question with packing specification or packing method, please contact your local CYStek sales office.

Material :

- Lead : Pure tin plated.
- Mold Compound : Epoxy resin family, flammability solid burning class:UL94V-0

Important Notice:

- All rights are reserved. Reproduction in whole or in part is prohibited without the prior written approval of CYStek.
- CYStek reserves the right to make changes to its products without notice.
- CYStek **semiconductor products are not warranted to be suitable for use in Life-Support Applications, or systems.**
- CYStek assumes no liability for any consequence of customer product design, infringement of patents, or application assistance.