

NPN Epitaxial Planar Transistor

BTC1510E3

Description

The BTC1510E3 is a NPN Darlington transistor, designed for general purpose amplifier and low speed switching application.

Features:

- High BV_{CEO}
- Low $V_{CE(SAT)}$
- High current gain
- Monolithic construction with built-in base-emitter shunt resistors
- Pb-free lead plating package

Equivalent Circuit

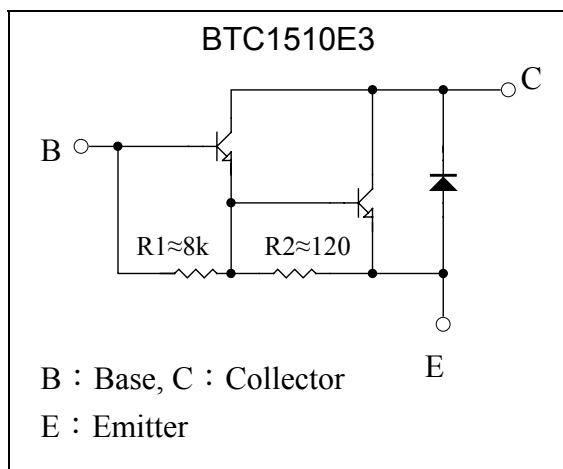

Outline

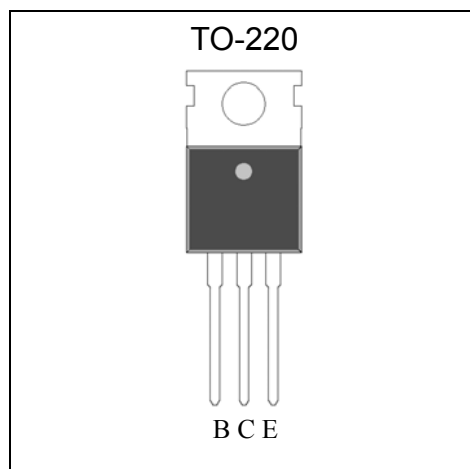

Ordering Information

Device	Package	Shipping
BTC1510E3-XX-UB-S	TO-220 (RoHS compliant package)	50 pcs/tube, 20 tubes/box, 4 boxes / carton

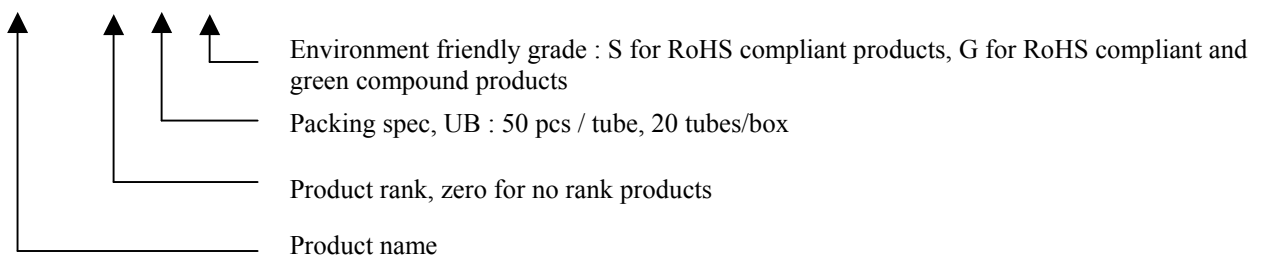



Absolute Maximum Ratings (Ta=25°C)

Parameter	Symbol	Limits	Unit
Collector-Base Voltage	V _{CB0}	150	V
Collector-Emitter Voltage	V _{CE0}	150	V
Emitter-Base Voltage	V _{EBO}	5	V
Collector Current	I _{C(DC)}	10	A
	I _{C(Pulse)}	15 *1	
Power Dissipation	Pd(T _A =25°C)	2	W
	Pd(T _C =25°C)	65	
Junction Temperature	T _j	150	°C
Storage Temperature	T _{stg}	-55~+150	°C

Note : *1. Single Pulse Pw=100ms

Characteristics (Ta=25°C)

Symbol	Min.	Typ.	Max.	Unit	Test Conditions
BV _{CB0}	150	-	-	V	I _C =100μA, I _E =0
BV _{CE0}	150	-	-	V	I _C =1mA, I _B =0
I _{CE0}	-	-	200	μA	V _{CE} =150V, I _E =0
I _{CB0}	-	-	200	μA	V _{CB} =150V, I _E =0
I _{EBO}	-	-	2	mA	V _{EB} =5V, I _C =0
*V _{CE(sat) 1}	-	-	1.5	V	I _C =5A, I _B =10mA
*V _{CE(sat) 2}	-	-	3	V	I _C =10A, I _B =100mA
*V _{CE(sat) 3}	-	-	2	V	I _C =5A, I _B =2.5mA
*V _{BE(sat)}	-	-	2	V	I _C =5A, I _B =5mA
*V _{BE(on) 1}	-	-	2.8	V	V _{CE} =3V, I _C =5A
*V _{BE(on) 2}	-	-	4.5	V	V _{CE} =3V, I _C =10A
*V _{FEC}	-	-	3	V	I _C =5A
*h _{FE 1}	2	-	20	K	V _{CE} =3V, I _C =5A
*h _{FE 2}	100	-	-	-	V _{CE} =3V, I _C =10A

*Pulse Test : Pulse Width ≤380μs, Duty Cycles≤2%

Classification Of V_{CE(sat) 1}

Rank	KA	N
Range	<1.1V	<1.5V

Typical Characteristics

Current Gain vs Collector Current

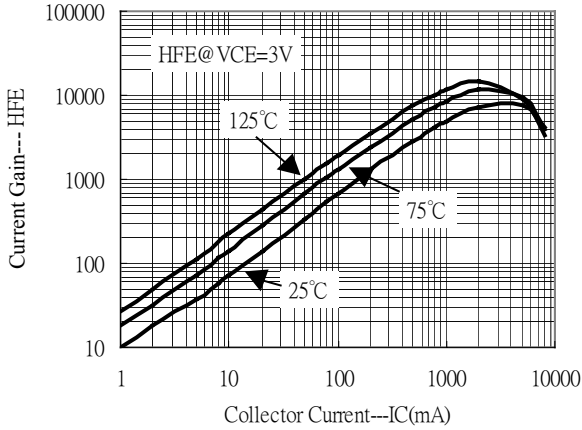

Saturation Voltage vs Collector Current

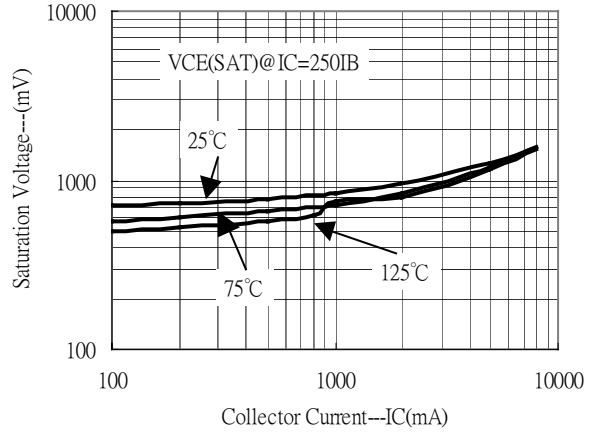

Saturation Voltage vs Collector Current

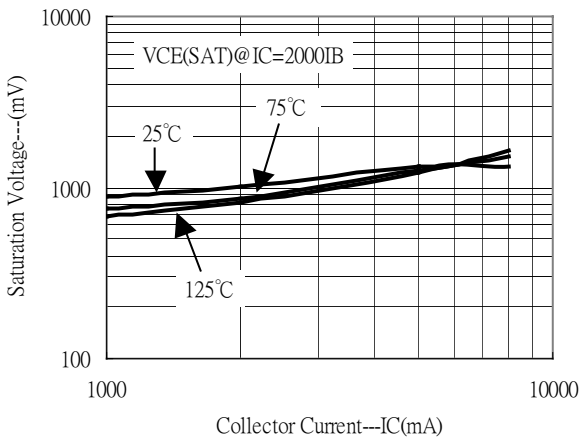

Saturation Voltage vs Collector Current

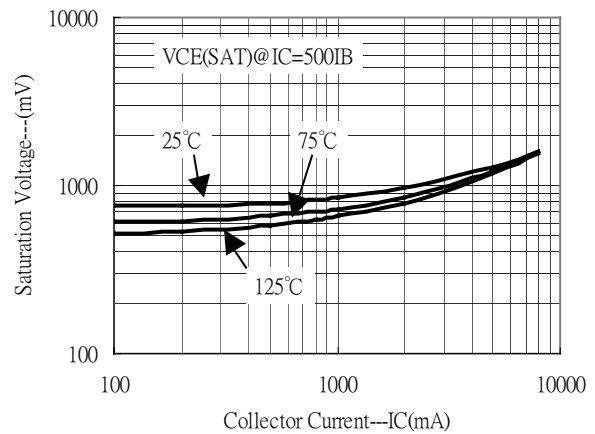

Saturation Voltage vs Collector Current

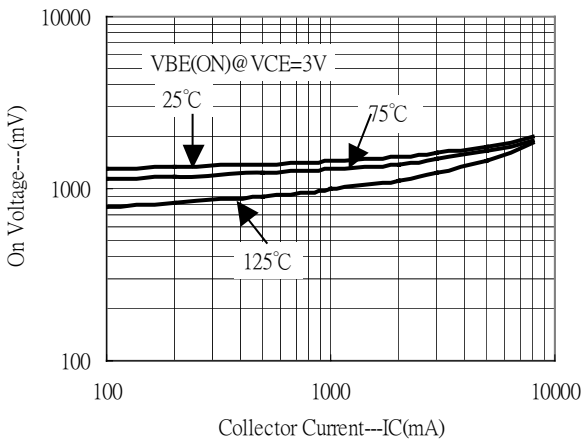

Power Derating Curve

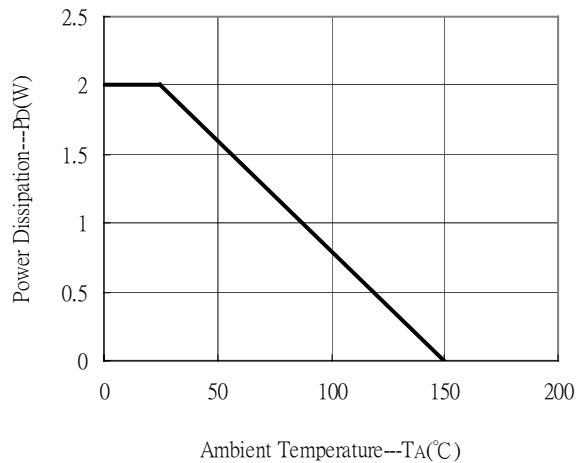



Characteristic Curves(Cont.)

Power Derating Curve

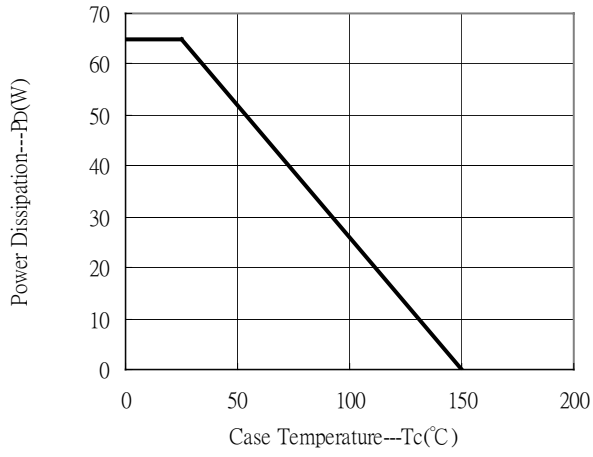

Recommended wave soldering condition

Product	Peak Temperature	Soldering Time
Pb-free devices	260 +0/-5 °C	5 +1/-1 seconds

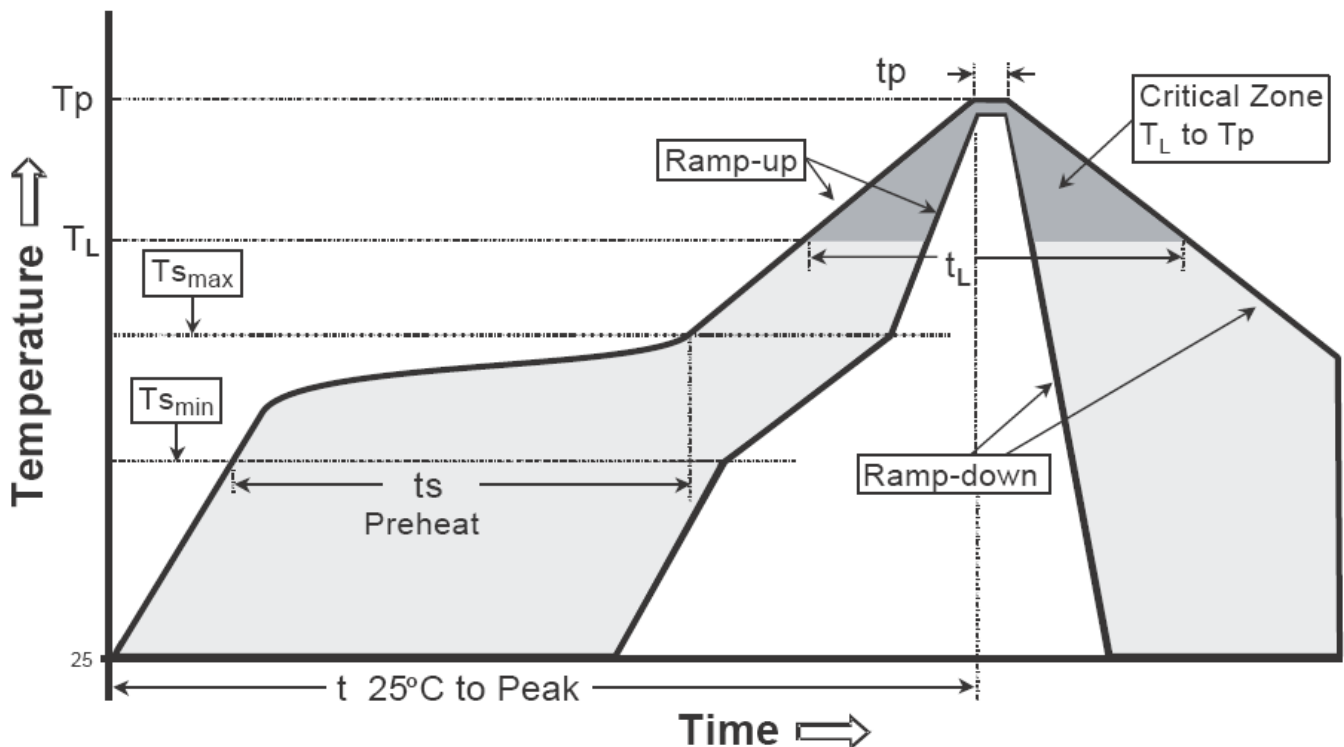
Recommended temperature profile for IR reflow

Profile feature	Sn-Pb eutectic Assembly	Pb-free Assembly
Average ramp-up rate (T _{smax} to T _p)	3°C/second max.	3°C/second max.
Preheat		
-Temperature Min(T _{s min})	100°C	150°C
-Temperature Max(T _{s max})	150°C	200°C
-Time(t _{s min} to t _{s max})	60-120 seconds	60-180 seconds
Time maintained above:		
-Temperature (T _L)	183°C	217°C
- Time (t _L)	60-150 seconds	60-150 seconds
Peak Temperature(T _p)	240 +0/-5 °C	260 +0/-5 °C
Time within 5°C of actual peak temperature(t _p)	10-30 seconds	20-40 seconds
Ramp down rate	6°C/second max.	6°C/second max.
Time 25 °C to peak temperature	6 minutes max.	8 minutes max.

TO-220 Dimension

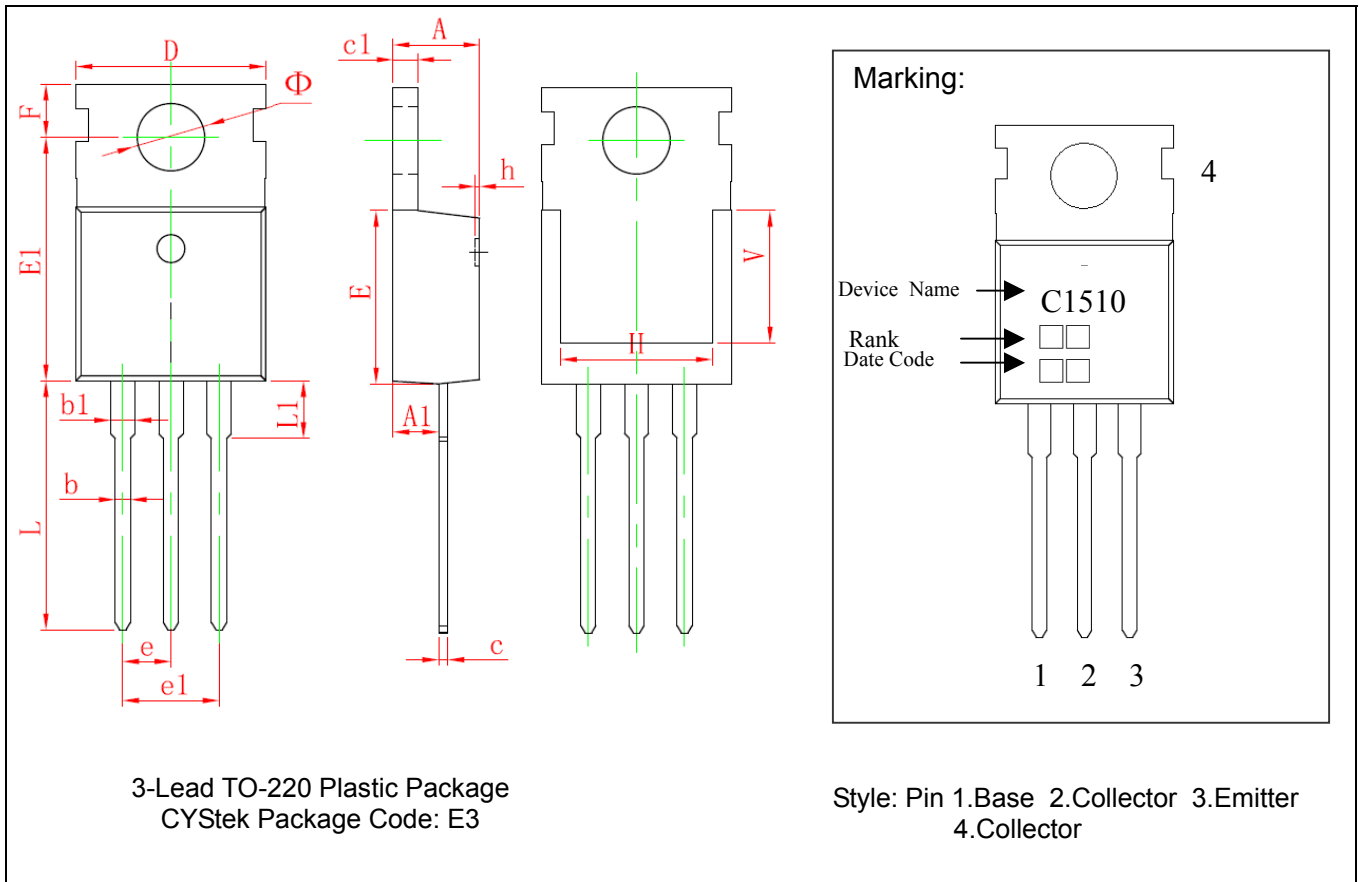

*: Typical

DIM	Millimeters		Inches		DIM	Millimeters		Inches	
	Min.	Max.	Min.	Max.		Min.	Max.	Min.	Max.
A	4.400	4.600	0.173	0.181	e	2.540*		0.100*	
A1	2.250	2.550	0.089	0.100	e1	4.980	5.180	0.196	0.204
b	0.710	0.910	0.028	0.036	F	2.650	2.950	0.104	0.116
b1	1.170	1.370	0.046	0.054	H	7.900	8.100	0.311	0.319
c	0.330	0.650	0.013	0.026	h	0.000	0.300	0.000	0.012
c1	1.200	1.400	0.047	0.055	L	12.900	13.400	0.508	0.528
D	9.910	10.250	0.390	0.404	L1	2.850	3.250	0.112	0.128
E	8.950	9.750	0.352	0.384	V	7.500	REF	0.295	REF
E1	12.650	12.950	0.498	0.510	Φ	3.400	3.800	0.134	0.150

Notes: 1.Controlling dimension: millimeters.
 2.Maximum lead thickness includes lead finish thickness, and minimum lead thickness is the minimum thickness of base material.
 3.If there is any question with packing specification or packing method, please contact your local CYStek sales office.

Material:

- Lead: Pure tin plated.
- Mold Compound: Epoxy resin family, flammability solid burning class: UL94V-0.

Important Notice:

- All rights are reserved. Reproduction in whole or in part is prohibited without the prior written approval of CYStek.
- CYStek reserves the right to make changes to its products without notice.
- CYStek **semiconductor products are not warranted to be suitable for use in Life-Support Applications, or systems.**
- CYStek assumes no liability for any consequence of customer product design, infringement of patents, or application assistance.